

AGRICULTURE — OTHERS.

SUGAR.

22/1/81 — 30/10/81

S Africa expects to export 600 000 tons of sugar

22/1/81
NAM

600 000
3 SUGAR

27

Financial Editor

SOUTH AFRICA expects to export 600 000 tons of sugar (worth £180m at current prices) in the season starting on May 1. Mr David Hardy, S A Sugar Association, export manager said yesterday.

There would be no commitments over this figure until the size of the crop was decided and at present the outlook, which is heavily dependent on the weather in the next eight weeks, is 'in the melting pot.'

Mr Peter Sale, general manager of the association, expects that the next crop may be between 1.8 and 2 million tons.

The first estimate will only be available at the end of May, Mr Hardy said.

He said that any surplus tonnage after meeting domestic requirements — just over 1 000 000 tons — would be 'marketed on a free basis rather than through contractual commitments.'

By the end of December South African sugar mills had produced 1 806 729 tons of sugar (down 22 percent on the two million-plus tons for the full previous season) and the target of 1.8m tons has been passed.

Production

Production was:

Umfolosi - 111 659 tons - up 14 percent; Entumeni - 21 997 tons - down 33 percent; Empangeni 72 372 tons - down 8 percent; Amatikulu - 125 644 tons - down 32 percent; Darnall - 84 577 tons - down 54 percent; Mount Edgecombe - 76 135 tons - down 24 percent;

Gledhow - 94 266 tons - down 46 percent; Glendale - 16 763 tons - down 46 percent; Noodsberg -

109 955 tons - down 26 percent; Union Co op - 50 004 tons - down 23 percent; Illovo 63 008 tons - down 28 percent; Sezela - 173 160 tons - down 18 percent.

Pongola - 97 747 tons - up 4 percent; Felixton - 89 539 tons - up 16 percent; Tongaat - 140 603 tons - down 35 percent; Umzimkulu - 101 157 tons - down 11 percent; Malelane - 166 283 tons - down 0.7 percent is still boiling off and will end with a higher figure

3-Sugar

8/2/81

UNION CLINCHES WAGE DEAL

BY JACK BRIGGINS

MORE THAN 10,000
sugar mill workers
will get a pay rise of
at least 14 percent in
April.

The new industrial agreement announced by the chairman of the Industrial Council for the Sugar Manufacturing and Refining Industry, Mr. W. R. M. Kullin, signals a period of stability in Natal's most vital industry.

It is understood that the negotiations, which extended over two months, were conducted in an amicable fashion and most of the parties were pleased with the outcome.

The main features of the new agreement are a 17 percent increase in minimum wages and at least 14 percent on actual basic pay. The agreement will run for two years.

The agreement includes a new promotion route for experienced workers which in effect will result in more cash in their pockets.

Most of the workers were represented by the National Union of Sugar Manufacturing and Refining employees which is one of the first black registered unions to enter into an industrial agreement.

Omskrywings

(1) 'Cabochon' beteken 'n steen met 'n massa van hoogstens 20 gram waarvan die bokant—

(a) 'n simmetriesgeronde konvekse of konkawe oppervlakte het; of

(b) 'n plat oppervlakte het, mits die steen rond-, ovaal-, halfmaan-, hart-, kruis-, of traanvormig is;

die basis kan rond, hol of plat wees.

(2) 'Kraal' beteken 'n steen van enige vorm met 'n massa van hoogstens 10 gram wat op so 'n wyse geboor is dat dit in 'n halssnoer geryg kan word.

(3) 'Eier' beteken 'n simmetriese eivormige steen met 'n massa van hoogstens 150 gram.

(4) 'Bal' beteken 'n simmetriese bolvormige steen met 'n massa van hoogstens 150 gram.

(5) 'Getuimelde steen' beteken 'n ongeslypte, ongesaagde steen met 'n onreëlmatige vorm en 'n massa van hoogstens 15 gram, wat behoorlik dermate getuimel is dat dit die voorkoms van 'n spoelklippie het.

(6) 'Beeldsnywerk' beteken 'n cabochon, kraal, eier, bal of getuimelde steen soos in hierdie regulasies omskryf, wat kunstig gegraveer of gebeeldsny is.

(7) 'Poleer' beteken die proses wat algemeen in die slypersbedryf aanvaar word waarby 'n steen deur middel van fyn skuurmiddels en poleerpoeiërs tot 'n volmaakte spieëlgladde voorkoms afgewerk word sonder die aanwending van lak of vernis".

Definitions

(1) 'Cabochon' shall mean a stone of a mass not exceeding 20 grammes of which the top forms—

(a) a symmetrically curved convex or concave surface; or

(b) a flat surface, provided the stone is either round or oval or crescent, heart, cross or tear shaped;

the base may be convex, concave or flat.

(2) 'Bead' shall mean a stone of any shape of a mass not exceeding 10 grammes which has been drilled in such a way that it can be strung in a necklace.

(3) 'Egg' shall mean a symmetrically egg-shaped stone of a mass not exceeding 150 grammes.

(4) 'Sphere' shall mean a symmetrically sphere-shaped stone of a mass not exceeding 150 grammes.

(5) 'Tumbled stone' shall mean an uncut, unsawn stone of irregular shape of a mass not exceeding 15 grammes which has been properly tumbled to such an extent that it has a pebble-like appearance.

(6) 'Carving' shall mean a cabochon, bead, egg, sphere or tumbled stone as defined in these regulations which has been artistically carved or sculptured.

(7) 'Polish' shall mean the process commonly accepted in the lapidary trade whereby fine abrasives and polishing powders are used to smooth a stone to a perfect mirror-like appearance without applying any lacquer or varnish".

No. R. 255

13 Februarie 1981

WYSIGING VAN DIE SUIKERNYWERHEID-OOREENKOMS, 1979

Ek, Dawid Jacobus de Villiers, Minister van Nywerheidswese, Handel en Toerisme, publiseer hierby ingevolge artikel 4 (1) (c) van die Suikerwet, 1978 (Wet 9 van 1978), die wysigings soos in die Bylae hiervan uiteengesit wat deur my kragtens en ooreenkomstig die bepalings van artikel 4 (1) (b) van genoemde Wet aan die bepalings van die Suikernywerheidsooreenkoms, 1979, aangebring is.

BYLAE

1. In hierdie Bylae beteken die uitdrukking "die Ooreenkoms" die Suikernywerheidsooreenkoms, 1979, gepubliseer by Goewermentskennisgewing R. 858 van 27 April 1979, soos gewysig by Goewermentskennisgewings R. 1941 van 31 Augustus 1979, R. 2435 van 2 November 1979, R. 310 van 22 Februarie 1980, R. 864 van 25 April 1980, R. 905 van 2 Mei 1980, R. 1623 van 8 Augustus 1980, R. 1933 van 19 September 1980, R. 2041 van 3 Oktober 1980 en R. 2514 van 5 Desember 1980.

2. Klousule 15 van die Ooreenkoms word hierby gewysig—

(a) deur paragraaf (a) van subklousule (2) deur die volgende paragraaf te vervang:

"(a) Die kwotas is basics, voorwaardelik, voorlopig of saadriet.";

(b) deur die volgende paragraaf by subklousule (2) te voeg:

"Saadriekwotas

(e) (i) 'n Saadriekwota is 'n kwota wat deur die Sentrale Raad bepaal en toegeken word wanneer daartoe gemagtig ingevolge spesifieke reëls wat deur die Suikervereniging vir toepassing tot 30 April 1981 goedgekeur is.

No. R. 255

13 February 1981

AMENDMENT OF THE SUGAR INDUSTRY AGREEMENT, 1979

I, David Jacobus de Villiers, Minister of Industries, Commerce and Tourism, hereby publish in terms of section 4 (1) (c) of the Sugar Act, 1978 (Act 9 of 1978), the amendments as set out in the Schedule hereto, which have been effected by me under and in accordance with the provisions of section 4 (1) (b) of the said Act to the provisions of the Sugar Industry Agreement, 1979.

SCHEDULE

1. In this Schedule the expression "the Agreement" means the Sugar Industry Agreement, 1979, published under Government Notice R. 858 of 27 April 1979, as amended by Government Notices R. 1941 of 31 August 1979, R. 2435 of 2 November 1979, R. 310 of 22 February 1980, R. 864 of 25 April 1980, R. 905 of 2 May 1980, R. 1623 of 8 August 1980, R. 1933 of 19 September 1980, R. 2041 of 3 October 1980 and R. 2514 of 5 December 1980.

2. Clause 15 of the Agreement is hereby amended—

(a) by the substitution for paragraph (a) of subclause (2) of the following paragraph:

"(a) Quotas shall be basic, contingency, provisional or seed-cane.";

(b) by the addition of the following paragraph to subclause (2):

"Seed-cane quotas

(e) (i) A seed-cane quota is a quota which has been determined and allocated by the Central Board when authorised thereto in terms of specific rules approved by the Sugar Association for application until 30 April 1981.

SUGAR ③ sugar

About face fm 13/2/81

Although sugar prices rallied this week, they remain some £100 below their early November peak of £410/t. And informed opinion is now, as sugar brokers B D & F Man put it, that "prices will actively seek lower levels"
The slump of the past three months.

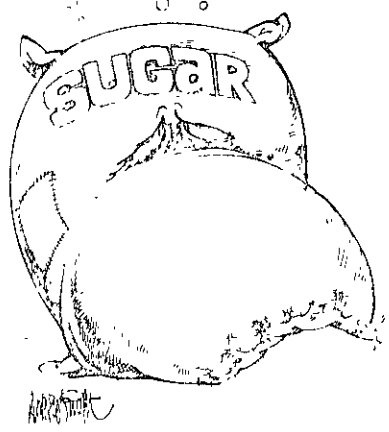

tion from corn sweeteners will intensify with several new varieties that are to be marketed sometime during the next 18 months or so.

This season's shortfall has thus been revised steadily downwards to 2 Mt and with expected yield recoveries in the 1981/2 season, prices have become depressed.

This week's rally, attributable to Soviet purchases of 500 000 t on the London market, is therefore likely to be shortlived. But as the Soviets will have bought 2,5 Mt by the week's end of the 3 Mt the market expects them to buy this season, and in the absence of other news to reinforce a tight supply situation, expectations are for prices between £220 and £250 for the rest of 1981.

With good rains in Natal in the last 10 days, SA's sugar crop could approach 2 Mt in the forthcoming SA season (May 1981/April 1982). Exports, says Sale, would then be about 850 000 t, below the average 1 Mt exported in the late Seventies but more than the present season's miserable 435 000 t, affected as it has been by drought.

If the price in the next year does average £235/t, some R340m net will be earned abroad.

CHEMICAL

which has seen daily raw sugar prices in London reach £235/t, was largely unexpected. Traders here and abroad believed prices would move upwards and at last November's FM investment conference, Sugar Association GM Peter Sale forecast world prices would reach £500/t.

This week, Sale told the FM that earlier assumptions that last season's tight supply situation would continue have been unfounded. The 1979/80 world season saw a production shortfall over consumption of 6 Mt and a fall in world sugar stocks to a low of 24 Mt. A similar shortfall was expected this year based on the normal increase in world consumption of 2,5 Mt to 3 Mt annually, poor crop production this season by several leading producers (Cuba, SA, the Soviet Union and Mauritius) and indications that Brazil, the world's largest cane grower, would not increase exports due to its expanding ethanol programme.

However, high prices have inhibited growth in world consumption, notably in the US, Canada and Japan, and competi-

Corporation Medals
For the best student in each
of the 2nd, 3rd and final years.

Second Year (Bronze Medal)

Miss G C Littlewort

Third Year (Silver Medal)

Miss N

Fourth

P M Sale

T J Cum

D P Week

J H Rens

B F McCl

Professor G

Awarded on :

examination:

student in l

Civil Engine

J H Rens

Sugar prospects improve after good rains

1/5 Tribune 3849a

Finance Editor

SOAKING rains in January and February have lifted the prospects for the current sugar crop and helped erase the memory of the drought.

Even the Empanenti and Heatonville areas, which were still suffering from dry conditions in December, have perked up.

But the scars of the drought — the worst for 50 years — are just below the surface. The first estimate for this year's slow-growing crop is between 1.8 million and 2 million tons compared with a more normal season of 2.2 million tons.

Last year the crop slumped 1.6 million tons and the industry was not able to take full ad-

vantage of the high export prices.

The general manager of the S.A. Sugar Association, Peter Sale, says the deficit for the season's crop is a humping R96 million, to add to the R50 million already borrowed by the industry.

It will take several years to wipe out the deficit. The industry has raised R50 million in

loans already to help cover the season's deficit and it is looking at ways of raising more loans, possibly overseas, to cover some of the remainder.

Some of the deficit can be absorbed in the industry by reducing returns on capital.

Sale expects the export sugar price to range this year between \$220 and

\$270 a ton and on the increased tonnage the industry should perform above the line for the first time in several years.

Prospects that there will be a large shortfall in sugar supplies this year have faded mainly because of the drop in consumption in the recession-hit developed countries. The London daily price touched \$410

last year and was expected to go even higher. The price now at \$280, seems likely to test levels closer to \$200, but not much lower because quotas will be invoked under the International Sugar Agreement.

Sugar statistician, F. O. Licht, has revised prediction of a deficit for the season ending in August from 4 million tons to 2.7 million tons.

Sugar price RDM 4/3/81 186 'will have 3 supa to be raised'

By GERALD REILLY
Pretoria Bureau

A SUGAR price rise is certain — but like other Government administered price increases, the announcement is only expected after the elections on April 29.

The general manager of the SA Sugar Association, Mr Peter Sale, said the price would have to be raised.

There was an annual increase in price to keep abreast rising production costs.

He said he was aware of stockpiling by certain big interests in anticipation of the coming price increase.

Because of the severe drought, and resultant big drop in overall production this year, surplus exports would drop from a normal 1-million tons to about 430 000 tons.

Mr Sale gave an assurance that the drought would not be a factor in the determination of the local price. The drought losses would be carried by exports.

To help support the big drop of nearly 600 000 tons of export sugar, the association had raised a loan earlier in the

season of R50-million.

To compensate for the substantial deficit made up of the amount needed to meet the full costs of production and the allowable return on capital, it was likely that another R46-million would have to be borrowed.

And yesterday, economists warned that the pile-up of post election price shocks could send the inflation rate soaring to 18% by the middle of the year.

Price rises due to be announced soon include, maize and maize products, all dairy products, the floor price of beef, and most dreaded of all by the lower income groups — bread.

Replying to the mini-budget debate in Parliament last month the Minister of Finance, Mr Owen Horwood, said if the bread price, was not raised soon the Government's food subsidy bill would rise to R300-million.

This was taken as a certain indication of a price rise almost immediately after the elections. The current bread subsidy is R180-million.

3 sugar (88) Aug 4/3/81

No truth in sugar price rise rumour

Consumer Reporter

A REPORT that the wholesale price of sugar would rise by 12 percent tomorrow was denied by a spokesman for the South African Sugar Association today.

He told The Argus, by telephone from Durban, that because the price of sugar is controlled, any increase had to be agreed to at Cabinet level.

'We have asked for an increase, which may be about 10 percent, because of our rising production costs,' he said. 'But no decision has been announced yet and there will certainly be no increase tomorrow.'

The spokesman said, however, that increases in rail tariff charges which come into effect on April 1 might also cause

the retail price of sugar to go up. The association was concerned only with the wholesale price of sugar.

Supermarket spokesmen said there had been rumours of an impending rise in the price of sugar for some time and were well stocked.

This meant that when the price did rise customers will not be affected

until new stock arrived.

Any increase in the price of sugar will also send up the prices of other products including soft drinks, sweets, cakes and biscuits.

Jams and canned fruits will not be affected for several months, because the present canning season is almost at an end.

Unions Wage all out battle

THE gloves are off in the sugar mills as unions battle it out for the allegiance of workers in this key industry.

The Sweet, Food and Allied Workers' Union, affiliated to the Federation of South African Trade Unions (Fosatu), is making a strong bid for membership and already claims control of Huletts' Empangeni mill. The secretary general of Fosatu, Alec Erwin, says the union is moving rapidly into the other 16 mills which are controlled by the registered black union, the National Union for Sugar Manufacturing

and Refining Employees and Refining Employees under Selby Nsibandé.

Nsibandé, an Inkatha man, as are most of his members, is confident of keeping out the new union. "They have no hope of conquering this industry," he says. About 6,000 men or 80 percent of the workforce are members of his union.

However, Fosatu appears to have stolen a march on their rivals by inviting the KwaZulu Chief Minister, Chief Gatsha Buthelezi, to address the Empangeni workers. The invitation has been accepted according to an aide of Chief Buthelezi.

Financial Editor 3/18
ASA 1003 Sugar Ltd
Chief Buthelezi

Nsibandé, who claims responsible progress in worker conditions since

A meeting at Dalton, addressed by Erwin, was well attended but only a few men signed up. He says workers did not have a real choice when they signed up as members of the other union.

registering last year, says Fosatu is trying to gain members by any means and is forgetting that the two unions have a common cause. He says Inkatha and the trade unions are the only organisations that can change attitudes in South Africa. Failure to recognise the common objective of liberation will delay the change.

Nsibandé says: "How can a white man fight for the rights of black workers?" He hopes to affiliate his union eventually to the Inkatha movement.

An application by the Sweet, Food and Allied Workers' Union for

registration in the Durban magistratal district was turned down after an objection was lodged by Nsibandé who represents the workers on the industrial council.

The union tussle poses a problem for employers, who must decide whether to deal with an unregistered union. The recent statement by Barlow's chairman Mike Rosholt, indicates that most mills will deal with these unions.

Huletts has not yet responded to Fosatu's takeover at Empangeni, but it is likely that they will reach a recognition agreement.

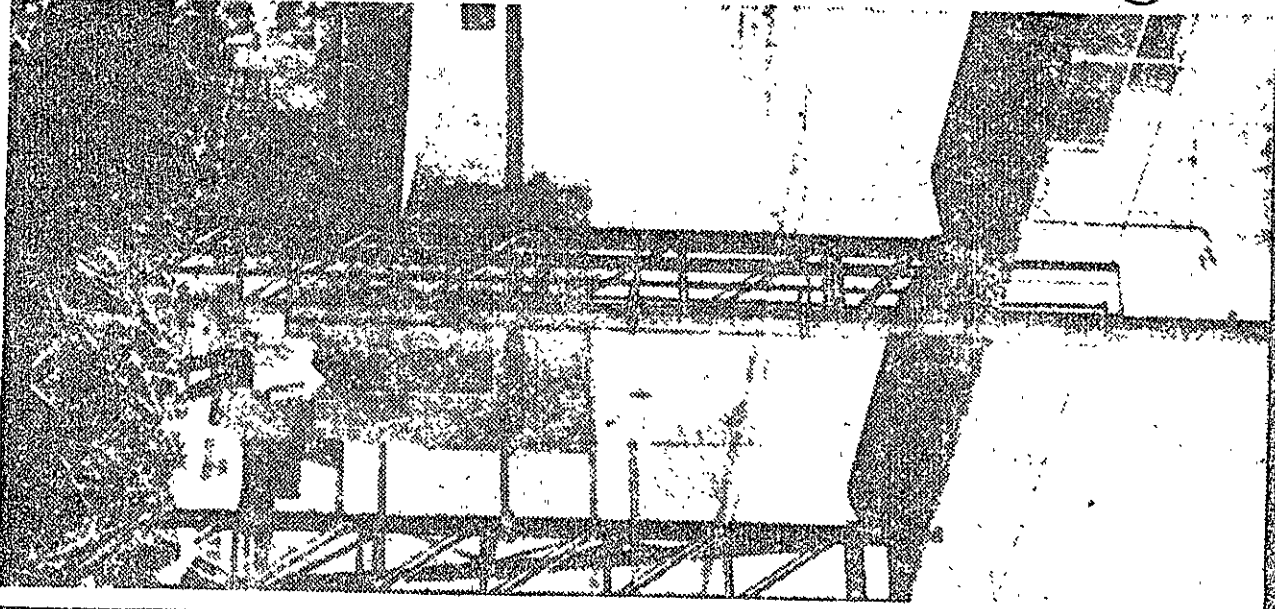

Mill workers . . . which way will they jump?

Sugar faces fearsome dilemma

By Tony Hudson

THE sugar industry is on the horns of a dilemma — to hedge or not to hedge.

Until the drought disaster last year, combined with rapidly rising world spot prices, the Sugar Association hedged a fair percentage of the crop, ranging from 10% 18 months ahead of shipment to a maximum of 40% to 45% between three and six months ahead.

However, now there is growing pressure within the organisation either to stop selling in the futures market or to reduce the percentage down to very low levels.

The non-futures pundits feel that once the sugar is sold at a prearranged price no advance can be taken of a rising market, which will result in a book loss for the association. Their opponents say, however, that the converse applies and that profits will be protected on a falling market.

Sugar Association general manager Peter Sale told Business Times this week that the ideal situation would be to sell at the spot price on a rising market and to hedge forward on a falling one.

"But," he says, "it is impossible to judge which is what these days. Operating in the futures market can be like gambling — you can't beat the tables. Why go through the hassles if you only break square in the end."

And hassles there can be. Sugar is sold forward at a fixed price, and if the spot price rises above the futures price the Sugar Association is required to lodge sufficient funds to cover the shortfall with the commodity clearing houses.

Early last year, says Mr Sale, the association was caught in an open position in the market and had to provide cover of \$112-million. And, he says, later in the year the price for a few days rose by the maximum of £20 a ton a day, which meant that about \$12-million had to be found every day for several days.

"Luckily, I was in London at the time and was able to cope with the situation," he says. But the exercise cost money, as rates in the UK were running at between 14% and 16% at that time, and the commodity houses do not pay interest on margins.

The Sugar Association ran into trouble last year well after a fair proportion of the crop had been sold on the futures market. As up to 75% of the cost of production is fixed, the rapid rise in the spot price of sugar combined with the drop in production from 2.2-million tons to 1.6-million tons — caused by the worst drought in the history of sugar growing in this country — pushed the breakeven point well above that calculated for the season.

The result was that the industry took a beating and a close look is now being taken at marketing techniques.

Mr Sale himself is happy to work with either futures or spot marketing as he feels both have advantages and disadvantages. But, whatever system is eventually decided on, there is no doubt that it will take time for the industry to recover from last year's disaster.

Mr Sale estimates that sugar production for the coming season will be only in the region of 1.9-million tons compared with the average of 2.2-million tons.

S. Times 2/5/81
3 sugar
1881

Sugar industry

S. Tribune 15/3/81

set to expand

...and thousands

of new jobs will be created

~~186~~ 3 sugar

THE Government is looking at the possibility of a substantial expansion of the sugar industry which will create thousands of new jobs and expand milling capacity.

An announcement is expected soon on the appointment of a committee of inquiry to look into the problems involved in expanding the industry. The last major expansion was in 1964.

At present the output is about 2,2-million tons of sugar a year of which half is consumed in the country and the rest is exported, earning around R400-million.

A larger output will boost exports and there could be problems if the International Sugar Association re-imposes quotas on member countries to counter falling world prices.

No comment was

By **JACK BRICKHILL**
Finance Editor

available from the South African Sugar Association but an industry source says the committee will comprise outsiders who are expected to take a broad view of the issues involved.

The Minister of Industries, Commerce and Tourism, Dr Dawie de Villiers, has been lobbied to authorise expansion in the Eastern Transvaal. A prime reason for the move is to create a developed buffer zone on the Mozambique border.

Also involved is the ethanol lobby which wants to convert a large proportion of the output

for fuel production. This will to some extent take care of the export problem.

The present mill at Malelane will be expanded or a new mill, costing at least R100 million, will be built in the Transvaal. Construction will take several years.

The committee may decide to recommend that estates be established in KwaZulu, Venda and other black areas.

It will have to decide on the question of dividing the spoils between millers and growers, and the modifications needed to accommodate new entrants to the industry. The extent of the expansion will have to be determined.

The sugar industry will take a back seat in the inquiry because it's only criteria for expansion is economic and not strategic.

Farmers now grow cane — for fuel and security

RDM 17/3/81

3 sugar

254

55

LYDENBURG. — Farmers in the remote Onderberg region, near South Africa's border with Mozambique, believe that sugar cane could help to solve the problems of border security and fuel shortages.

To prove their point, they are seeking Government aid to expand cane production.

The Government is seeking to halt infiltration from Mozambique by guerrillas of the banned African National Congress — as it made clear in January when South African troops made a lightning strike against three houses described as ANC headquarters in a suburb of the capital, Maputo.

However, infiltration into this largely undeveloped area is

easy, and the border is marked only by a simple fence.

One answer, the Government believes, is further settlement and development of the Onderberg, which boasts almost ideal growing conditions. But its traditional crops of cotton and vegetables are barely profitable.

Soaring fuel costs have affected vegetable crops, which must be transported about 400km to markets.

Local farmers believe the answer lies in sugar cane, already the major crop for ones such as Mr Jan Lourens and his son, who have 1 000 hectares of their 10 000 hectares under cane.

In the last season, Onderberg

farmers delivered a record 1 600 000 tons to the local sugar mill.

Cane is not cheap to produce, because it needs overhead irrigation. Mr Lourens puts his water bill at R7 000 a month.

To deal with that problem — with the aid of the British Tate and Lyle Corporation — farmers have drawn up extensive plans for a second mill and are seeking Government backing.

As an added incentive to the Government, the project calls for the mill to crush two million tons of cane a year — half for sugar, and half for ethanol — an important consideration in South Africa.

Mr Lourens is confident that despite its price tag of R140-

million, the mill is a sound proposition, providing it can get a guaranteed annual quota of 100 000 tons.

The overall project — mill, irrigation canal and railway spur — would cost about R350-million. It will eventually provide 10 000 to 20 000 jobs, 95% of them for blacks.

The question of jobs and better housing for blacks preoccupies many farmers in the area.

"As we develop, so must they," says Mr Lourens. "As we pushed forward with clearing the land and building our farms, I think we neglected them. Now we must go back and clear up these matters."

— Sapa-Reuter

500 back at work after dispute

3-Sugar

Mercury Reporter
 MAINTENANCE work at the Tongaat sugar factory resumed early yesterday when about 500 African and Indian employees returned to work.

pute, in the sugar division of the group, had been resolved early yesterday morning. No one had been penalised in any way.

According to Dr T G Cleasby, deputy managing director of the Tongaat Group, workers downed tools on Thursday in support of 17 of their colleagues who had refused to accept new positions at the factory.

Dr Cleasby said yesterday that the domestic dis-

Note: This total is 44 because one previous job. Fu listed above as having had also worked on farm they

Number of workers	Employer	Area and area.
44	Other farms	'Karoo'
1	S A R & H	Beaufort West
4	Renosterkop station	(between Beaufort West and Nelspoort)
1	Middelburg	Middelburg
1	Building Contractors	Beaufort West
1	Cartage contractor	?
1	Divisional councils	Beaufort West
1	Middelburg	Middelburg
1	Household (as gardener)	Beaufort West
2	Vegetable market	Beaufort West
1	Farmers' Co-operative	Beaufort West
2	Nelspoort Sanatorium	Nelspoort
1	Coronation Collieries	Natal

TABLE 29

Distribution of workers according to previous job, by employer and area.

worked on the railways, three for building or cartage contractors and three for divisional councils (building roads). Only one worker had ever worked outside the Cape, at Coronation Collieries in Natal.

urers have kept their stocks at a low level, could generate a surge in demand ahead of the appearance of the southern hemisphere harvests.

But the backwardations in the futures markets indicate that market operators are looking ahead to the 1981-82 season. That picture is extremely murky. Czarnikow says there is a strongly held belief that consumption, if for no other reason than population growth, must get off its recent plateau and into the 91 Mt-93 Mt area, although increasing usage of high fructose syrups in the US (1.8 Mt last year), Canada and Japan is a competitive factor.

Production is also expected to recover, however. EEC plantings of new crop beet are 5.5% up, according to F O Licht, the German statisticians, while Spain, Turkey and Yugoslavia are planning for as much as 30% more to restore them to positions of near self-sufficiency. Among cane growers, SA and Mauritius could be back to normal, while India is looking for a 27% increase to 7 Mt (white value).

For the moment, the market is quiet. Final buyers are reluctant to commit themselves to shipments beyond the next two months, although Mexico recently bought 100 000 t for May to October delivery at fixed prices. Equally, producers are holding off while they try to negotiate contract prices.

"The physical market is in a limbo," commented traders E D & F Man in London. And on the futures markets prices could depend on short covering, further falls in US interest rates and the chartists, who currently maintain that any fall through the 22c/lb "resistance level" will be very bearish.

6% on the spot London daily price of raws. London's biggest traders in the commodity, C Czarnikow, admitted: "The market is very unsettled and it is not at all clear where we go from here." Two basic props have been kicked out from under the sugar price — Russian buying and the production-consumption deficit, which was expected to cut world stocks to below the "equilibrium" level by the end of the current season in September.

Russia's purchases, put at around 3 Mt, were so well flagged by the market that the final round of buying in January came as a damp squib. In fact, as the Russians took physical supplies, it is believed they liquidated forward long positions (taken out last year as a hedge) and added further pressure to the market. It is possible the Soviets may need more supplies, but that will depend on whether Cuba fails to meet its commitments.

The fall in world stocks has also had to be recalculated in view of the failure of consumption to break out of the 89.5 Mt-90 Mt range in which it has stagnated for the last three years. Opening stocks were put at 26 Mt and on the basis of falling production plus hopes for demand, the shortfall was originally estimated by the optimists at 5 Mt-6 Mt.

Latest production forecasts of 86.5 Mt-87 Mt and offtake of some 89.5 Mt will, however, limit the reduction in stocks to 3 Mt at best — leaving them just above the pivotal area for prices of 25% of consumption, compared with earlier predictions of 22%-23%.

On top of this disappointment for the bulls, the EEC still has another 1 Mt to shift between now and June to keep its sugar mountain at desired levels. It has come under attack from the Australians, among others, for allegedly subsidising these exports to the detriment of other producers.

Short-term hopes for the price tend to rest on imponderables: good spring weather or an early summer in the US, where big consumers such as soft drink manufac-

SUGAR (3) Sugar
Poor outlook

FM 20/3/81

International sugar markets were fishing for the bottom this week after coming up off 12-month lows in London — some 44% below the peaks of £400/t-plus hit last November.

With prices on the futures (terminal) market trading at discounts ranging up to

500 workers down tools in support of 17

3-Sugar

nm 20/3/81

Mercury Reporter
MAINTENANCE work came to a halt at the Tongaat sugar factory yesterday when about 500 Indian and black workers downed tools in support of 17 colleagues involved in a dispute with the factory management.

A spokesman for the Tongaat Group said yesterday the stoppage affected

only the sugar division and workers were not demanding an increase in wages or an improvement in working conditions.

Last week 17 workers had been asked to change jobs in the plumbing section.

In spite of being told the change would not mean a decrease in wages or status, the workers resisted.

The spokesman said the 17 had been given a written warning last week that they had to comply or face disciplinary action.

To our surprise, 400 to 500 workers downed tools in support yesterday.

The spokesman said the workers were all members of the registered National Union of Sugar Manufac-

turers and Refinery Workers led by Mr Selby Msibandé. The union had been formed last year.

The spokesman said the work stoppage was unofficial and not in terms of the Industrial Conciliation Act. Sugar workers were due for a 17 percent increase in wages from April 1.

Hours worked per week	Number of workers	Cumulative %
0 - 46	1	0,92
46,1 - 48	11	11,01
48,1 - 50	26	34,86
50,1 - 52	16	49,54
52,1 - 54	22	69,72

Distribution of workers according to working hours (weekly):

TABLE 5

The following table is an attempt to list the distribution of workers according to average (i.e. throughout the year) working hours.

Working hours on Karoo farms differ considerably between summer, when the day begins earlier and ends later, but with a long break in the middle, and winter, when the working day, and the break, are shorter.

part of working hours, especially where the worker is restricted in his choice of both working and living place. The farm worker, on the other hand, walks perhaps 500 metres to start work - although in the course of the day he may be required to walk much further).

27/3/81
Sugar
industry
inquiry

PRETORIA. — The appointment of a committee of inquiry into the Sugar industry was announced here last night by the Minister of Industries, Commerce and Tourism, Dr Dawie de Villiers.

Its terms of reference are to inquire into, report and make recommendation on: The expansion of sugar production in South and Southern Africa with due regard to its geographical distribution and economic, social and strategic factors.

● The effectiveness of the local marketing system with special reference to whether there is justification for the continued application of the existing price regulating measures within a free economy.

● The system of marketing sugar abroad.

● The basis on which the division of proceeds formula should be adjusted from year to year for changing price levels.

The six-member committee will be chaired by Dr A J V Rorich, general manager of Imperial Cold Storage. — Sapa

Barclays steps in with a loan to small cane growers

S. Tribune 29/3/81

3 sugar 107
248

BARCLAYS Bank has stepped into the breach with R2 million for small black, Indian and coloured cane farmers in a move that will strengthen the base for large-scale cane growing, particularly in KwaZulu.

This is the first contribution from outside the sugar industry to the South African Sugar Association's small growers' financial aid fund. Peter Sale, general manager of the Sugar Association, says it is hoped to attract more capital to the fund from

Finance Editor
financial institutions in South Africa and overseas.

Barclay's loan at an interest rate of 8,5 percent will help to boost loans to small farmers in the 1981/82 season to R3,8 million. The fund plays a vital role in helping farmers in KwaZulu to move beyond the subsistence level.

Considerable assistance has already been given by individual sugar groups and the Sugar Association.

At the end of March 1981, loans of R10 million had been

granted to 8537 or 65 percent of the total number of small growers.

In a related development, C. G. Smith has opened a new maintenance depot at Mtwalume. The company supplies expertise and equipment and subsidises cane land development on behalf of black farmers.

The full extent of development of cane growing in KwaZulu hinges on the committee of inquiry into the industry announced this week. Many of the details appeared in Tribune Finance two weeks ago.

Beaufort West
RSE OR COM
erns,

For the estimates of payment in kind, grazing has been valued at the rates then current on the Beaufort West City Council common ground. Farmers' estimates of the grazing value of their land varied enormously; to some extent this may reflect actual variations in quality but it again seemed safer to apply a uniform rate to all.

(127 workers had no cattle at all)

one had 5 cows.
one had 2 and
One worker had one cow,

Cattle:

4 had 4 donkeys.
3 had 3 donkeys and
21 had two donkeys
2 had one donkey each,

100 workers had no donkeys, (76, 92%)

Donkeys:

3-Sugar

2/4/81

Pietermaritzburg Bureau

FIVE hundred Dalton sugar and bark mill labourers will automatically resign if they ignore a call to return to work today after a two-day strike.

Police were on standby in the area yesterday after labourers who were allegedly coerced into striking by threats and 'massive intimidation reported to management at Union Co-operative Bark and Sugar Company, said Mr Tony Charlton, personal assistant to the managing director.

The strikers downed tools on Tuesday when they received increased pay packets instead of a meal while on shift, said Mr Charlton.

Black labourers, until yesterday, were entitled to a meal while on shift, while their Indian and white counterparts were not, he said.

To align the workers the meal was to be taken away from the black labourers, who received 20 percent pay increases across their grades.

At the same time, some of the Indian workers received increases ac-

ording to their grades, while white workers received increases on 'merit negotiation'.

A round-the-clock maintenance programme on the co-op's sugar mill and wattle extract plant and production at the wattle bark mill ground to a standstill as workers went on strike.

Mr Charlton said he could not estimate the production loss during the work stoppage.

'We have been negotiating this matter with the staff liaison committee since January,' he said. 'The

management's door has always been open.'

Workers had made demands for an excessive food allowance, he said, which was way out of proportion with anything that could be met by the management.

'As they are striking illegally we have no choice but to let them resign automatically if they do not return to work today,' he said. If workers did not return by the ultimatum set but wished to return later, they would be re-employed on their old salary scales.

6 The Natal Mercury, Thursday, April 2, 1981

Mill workers strike over meals

~~1981~~

3-Sugar

3-Tinber

(b) Major assumptions used are that domestic Africans may migrate from region-type to region-type but not in and out of South Africa as a whole while foreign Africans may migrate from outside the country to a particular region-type and back again, but not between region-types.

Sugar up 11 pc today

DURBAN — The cost of refined sugar will increase an average 11 per cent throughout the country today.

And there are also indications the price of red meat will go up drastically in the next few months.

The increase in the price of sugar, announced by the South African Sugar Association yesterday, will have a ripple effect on all other foodstuffs with a sugar content, such as cakes, confectionery and mineral water.

While the average increase will be 11 per cent, this will not be uniform throughout South Africa because of rail costs.

Mr I. G. B. Smeaton, chairman of the Sugar Association, said the effects of the recent drought had not been passed on to the consumer but absorbed by the industry.

Of the 11 per cent increase 7,2 per cent would go to cover higher production costs, 1 per cent to cover increased packaging costs, 1,3 per cent to retailers and 1,5 per cent to increased rail costs.

The price of red meat will probably also be increased drastically in the next few months.

Several spokesmen for the meat industry said yesterday that a variety of factors would cause the increase.

The chairman of the Feedlot Owners Association and president of the Livestock Auctioneers and Allied Industries, Mr Dennis Caine, said the new system of grading contemplated by the Meat Board would aggravate the meat shortage and push up prices.

A second factor was the increase in abattoir tariffs.

18/11/83
 DO
 3-2-83
 3-2-83

immigration into the home...

(e) Within the context of a secular decline, the pattern of foreign male immigration/emigration to South Africa is similar to the pattern to domestic

While it may involve no physical change, changes their status to a greater or lesser degree.

The populations in each region-type are connected by birth, death and migration rates. Birth and death rates will be taken from other investigations; migration will be estimated in the course of this study. If one were to assume that birth, death and migration rates would remain constant indefinitely at their 1975 - 1980 levels, it is possible to show that there would ultimately be a *stable* distribution of population between ages, sexes and region-types, i.e. that the proportion of population in each cell of the distribution would remain constant while the total population grows at a constant rate. The properties of this distribution will be discussed, even though it should be made clear that one is working in the realm of counterfactuals here: birth, death and migration rates will certainly change in the coming years, (the former two fairly slowly). The reason these properties are of interest is that they display clearly the *tendencies* in present migration patterns (given birth and death rates); to the extent that the continued operation of these tendencies give rise to an absurd population distribution, a re-adjustment of African population movement patterns must be expected in the coming decades.

REVIEW OF EARLIER WORK : PROFESSOR NATTRASS'S ESTIMATES OF MIGRANCY AND MIGRATION

In two works, *The Migrant Labour System and South African Economic Development 1936 - 1970* (Nattrass, 1976) and *Migration flows in and out of capitalist agriculture* (Nattrass, 1977), Nattrass has pioneered quantitative estimates of the extent of African migration in South Africa. Central to her approach is a distinction between temporary and permanent migrants, temporary migrants being 'those men² [sic] who leave their families behind,

NM 3/4/81 ~~11:30~~
3-Sugar ~~4:15~~

Police arrest 300 workers at Dalton plant

Pietermaritzburg Bureau
POLICE arrested 300 workers at a Dalton company yesterday afternoon after they ignored a warning to leave their company's premises.

The employees, of the Union Co-Operative Bark and Sugar Company, would all be charged with trespassing and would appear

in the New Hanover Magistrate's Court today, a senior police spokesman said.

The police had moved in and arrested the workers at the request of the company management after they had failed to leave the premises during a stipulated time period, the spokesman said.

The move by police came

as the strike moved into its third day with about 460 workers demanding food allowances at the plant.

The workers were arrested yesterday after company management had warned them they were striking illegally and would be treated as having automatically resigned if they did not return to work as usual yesterday

Attitude towards family planning: (Table forty four)

Response	Percentage of total.	Percentage of non-main.
Uses contraceptives	30%	74%
Does not know about family planning	12%	50%
Does not believe in family planning	6%	34%
Family disapproves	6%	67%
Does not apply	16%	63%
Knows but no action	30%	14%

Mother and mother figures educational level

(Table Forty Five)	No education	37%	70%	30%
Sub A or B	2%	100%		
Std 1-3	31%	45%		55%
Std 4-6	22%	40%		60%
Std 7+	8%			100%

The responses reflect a correlation between the level of formal education and the occurrence of malnutrition but not exclusively so. The lack of education must be seen as one of the causes of the apathy so frequently encountered when working with rural people. It is through education and technology that men learn that a certain degree of mastery over environmental social and natural obstacles is possible. However, for the rural person catastrophes at family or community level are seen as the results of forces over which they have no control - the displeasure of ancestors, bewitchment etc. It must be understood that in an undereducated state this is the only adjustment that an individual can make to an apparently hopeless situation.

This explains the responses which reflected a general lack of conviction about the cause of the disease, the steps needed to prevent a relapse; and the need for family planning. It also explains the adherence to traditional practices and the readiness to pursue traditional forms of treatment

The investigations lead us to believe that the mother or mother figure of the malnourished child was likely to have certain characteristics:

- she has little or no formal education,
- she is not convinced of the cause of her child's illness
- she is likely to believe in the value of traditional health practices viz. giving enemas
- she is not likely to be motivated towards family planning
- she is likely to be unmarried, or if married the customary lobola obligations will not have been met.

Adied to which the household in which she lives is also likely to have certain characteristics.

Mr Brian Bevan, spokesman for Spar Foodliners, said last night that the 11 percent increase on a 1 kg packet of sugar would be 'in the region of 4 c, and a 2,5 kg packet about 10 c'.

The increase is expected to compensate for industry's higher production costs and the recent rail increases.

According to Mr I G B Smeaton, chairman of the Sugar Association, the effects of the drought which the industry had just come through had not been passed on to the consumer but had been absorbed by the industry.

Of the 11 percent increase, 7,2 percent would go to the industry to cover higher production costs, 1 percent to cover increased packaging costs, 1,3 percent would go to retailers and 1,5 percent would represent the average increase in rail costs.

FROM today the cost of refined sugar will increase by an average of 11 percent throughout the country.

The increase, announced by the South African Sugar Association yesterday, will have a ripple effect on all other foodstuffs with a sugar content, such as cakes, confectionery and mineral water.

- their local shop is not likely to stock fresh milk
- they are very, very unlikely to have a dependable, safe sugar supply.

- the conventional health worker's response to the mother and her malnourished child will be to
- give her advice on how to feed the child
- offer her a packet of powdered milk at a subsidized rate
- recommend that she attends the family planning clinic.

The health worker has done her bit. Another 'case' has been recorded and attended to; but the problems at community level that have precipitated the onset of the disease remain untouched.

Sugar 3/4/81
 3. Sugar
 Finance Reporter

3/4/81 152 140 186 Sugar

300 sugar mill strikers arrested

Own Correspondent

JOHANNESBURG. — Police arrested about 300 striking workers at the Union Co-Operative Sugar Mill at Dalton, Natal, yesterday.

Police told representatives of the Sweet, Food and Allied Workers' Union that the workers would appear in court today charged with trespassing.

The workers were arrested as the strike at the mill entered its third day. The company had told the workers they were dismissed, but union sources said the workers still regarded themselves as Union Co-Operative employees.

The general secretary of the Fosatu-affiliated SFAWU, Mrs Maggie Magubane, said yesterday that only four workers were at work inside the mill yesterday. About 450 were still on strike.

The workers are striking in protest at a management decision to cut their food rations. Management argued that the loss of earnings occasioned by this was compensated for by a 17 percent wage increase granted to all sugar workers this week in terms of the industry's Industrial Council agreement. Workers rejected this and demanded extra compensation.

The company refused to negotiate with the union, which said it represented most of its workers.

Mrs Magubane said a worker committee had seen manage-

ment in an attempt to negotiate on the dispute, but that the company had told them it was not prepared to change its decision.

Management had been prepared to negotiate with Mr Selby Ntsibande, who runs a rival union initiated by sugar employees. However, Mr Ntsibande had also been unable to make any headway in altering the decision.

● Meanwhile, the 2500 strikers employed by Ilco homes in Durban returned to work yesterday after a management warning that they would be fired if they did not return.

They had struck for four days over a demand that they be paid fortnightly instead of weekly.

The company's managing director, Mr Jos Demmers, had offered to hold a worker vote on the issue. This failed to end the strike and yesterday Mr Demmers warned that workers who did not return this morning would be dismissed.

KDM 3/24/81
Price of
sugar up
by 11%
today

Own Correspondent

DURBAN. — From today the cost of refined sugar will increase by an average of 11% throughout the country.

The increase, announced by the South African Sugar Association yesterday, will have a ripple effect on all other food-stuff with a sugar content.

The price increase is expected to compensate for the industry's higher production costs and the recent rail increases which came into effect at the beginning of the month.

According to Mr I G B Smeaton, chairman of the association, the effects of the drought which the industry had just come through had not been passed on to the consumer but had been absorbed by the industry.

Of the 11% increase, 7,2% would go to the industry to cover higher production costs, 1% to cover increased packaging costs, 1,3% to retailers and 1,5% to represent the average increase in rail costs.

Table 11 Contrast of Operation of Two Large Hospitals, 1974

	White Hospital	Black Hospital
Total Patient Days (b)	290 296	902 217
Percentage of White (c) In-Patients	68	—
Percentage of Beds Occupied	64	93
Ratio of Daily Patients to : Doctors	7,2	13,5
Nurses	0,7	1,7

Strikers told to pack up and go
 Rat 4/4/81
 184
 152
 140A
 3800

By STEVEN FRIEDMAN
 Labour Reporter

ABOUT 400 striking workers at Union Co-Operative Sugar Mills at Dalton in Natal are likely to be deported back to KwaZulu, say union sources

A spokesman for the Sweet, Food and Allied Workers Union said last night that workers understood that they were to be transported back to the homeland.

He described the situation outside the mill as "tense". This followed a management instruction to workers to leave their compound housing by late yesterday.

Workers were gathered on a company soccer field last night

Earlier 414 workers appeared in court for a hearing in connection with the strike. No bail was set, and the workers were released with a warning to appear in court on May 6.

The workers were arrested outside the mill on Thursday. They have been on strike since Tuesday in protest against a management decision to cut their food rations. They allege that they have not been compensated adequately.

Management at the mill has refused to discuss the strike with the Press, except to confirm that it refuses to negotiate with the union.

A union spokesman said last night the contract workers had returned from court to be told to collect pay and leave their compounds. Police arrived

A spokesman claimed that late yesterday it was understood that management had ordered buses to take the men back to homeland areas such as Swinburne and Stanger

"This is a totally unacceptable method of resolving strikes. Management has consistently refused to negotiate with the union on the workers' grievances. It has fired them, and now seems set on forcing them to return to the homelands," the union spokesman said

- (a) The Hospitals are Addington and King Edward VIII, both in Durban.
- (b) In patient days are estimated as the sum of in-patient day and at 1/3 of out-patient attendances.
- (c) The remainder are Coloured.
- (d) In patients only.
- (e) Provision and medical supplies at White patient cost, number of patient days reduced by the ratio of Daily Patients/Doctor in Addington to the ratio of Daily Patients/Doctor in King Edward.
- (f) As for (e) but number of patient days reduced by the ratio of the percentage of beds occupied in the Addington to the percentage of beds occupied in King Edward.
- (g) The number of doctors and nurses in both hospitals was obtained from their establishments, but both were reported to be almost fully staffed.
- (h) Sources:
 Report of the Director of Hospital Services for the year 1974, Province of Natal, The Provincial Auditor's Report on the Appropriation Accounts for the period 1st April 1974 to 31st March 1975, Province of Natal, and Estimates of the Expenditure to be defrayed from Revenue during the year ending 31st March, 1974, Province of Natal.

hospital, and the level of bed utilization in both was similar to the national average. In order to examine the effects of the differing quality of service in the Black hospital, its costs were recalculated under two different sets of assumptions. In terms of the first assumptions patient costs of food and medicines are assumed to be equal to those in the White hospital, and the number of patient days is reduced to allow the same ratio of patients to doctors as the White hospital. The second set of costs is derived by assuming that the same percentages of beds

ack hospital as in the White
 o achieve this. Other
 first set of assumptions.
 e costs per patient day by
 sumptions try to examine
 offering services of the
 igh the results are
 of service accounts for

... 7 per cent and 45 per cent of the differences in these hospital's costs. The remaining differences are largely attributable to wage differentials between Black and White staff in the two hospitals. It is clear that there is a considerable variation in the quality of service provided to Blacks and Whites in the two hospitals chosen for this example, and the pattern is likely to be a general one, since this pattern of hospital costs per patient day is found in most provincial hospitals. The regional distribution of hospital beds indicates a pronounced urban bias for Blacks, and a smaller bias for Whites (31). In 1970 the number

(31) This pattern is prevalent in developing economies. See M. Lipson, Why Poor People Stay Poor.

A bad year for sugar, but groups profit

By Tony Hudson

DESPITE a disastrous year for sugar, two of the three Natal sugar giants expect improved results this year.

Both Hulett's and Tongaat, whose financial years ended on March 31, say that, while sugar earnings have taken a heavy knock because of the drought and unexpected price fluctuations, profits from other divisions will lead to overall increases in group profits.

Tongaat financial director Ted Garner said this week that earnings should be 115 cents on the pre-split basis and 97 cents on a post-split basis.

It seems that, despite the bad sugar season, the group will meet its objective of 25% growth for the last financial year.

Based on last year's figures, this will put gross turnover in the region of R375-million and, after tax profit, at around R21-million.

"This proves," says Mr Gar-

ner, "that diversification pays. We believe that Tongaat as a company has benefited almost more than any other company in South Africa from diversification. We have not had a drop in earnings since 1969."

There is no doubt that the boom has helped Tongaat overcome the drought problems. The huge demand for bricks not only did away with Toncoro's R50-million brick stockpile, but also caused a number of plants that had been closed to reopen.

The acquisition of Hebox Textiles and H Lewis and the expansion programme at David Whiteheads also played their part in keeping growth at expected levels.

Hulett's managing director, Dr Kees van der Pol, told Business Times that, despite the

hefty drop in profits from sugar, revenue from other sources increased. This would give the group overall growth for the financial year just ended.

He said earnings from Hulam should more than double for the year, and that the company is very happy with the results from the Zimbabwe operation at Triangle.

The project was allowed to repatriate 50% of profits during the year and a further dividend is expected.

As for the current year, Dr Van der Pol expects the total size of the sugar cake to increase by about 10%.

He said Hulett's was hard hit as its operations suffered a two-and-a-half year drought.

Current rainfall figures, while up on last year's by a considerable margin, are still low

3/5/81



5/4/81

S. Times

Cane crop threatened

Sugar S. Tribune 12/4/81

By JACK BRICKHILL Finance Editor

THE spectre of another serious drought is looming over Natal's cane lands and as each day passes the chances of good rains recede.

Some areas north of Durban have been without rain for four weeks and farmers are hoping for a wet Easter.

The rain that has fallen in areas around Eshowe, Empangeni and St Lucia in the last few days has, according to the Met Office, only wet the grass. "We don't expect exceptional rains at this time of the year," says a spokesman.

Ernie Morrison of the South African Cane Growers' Association says the position is not nearly as bad as last year's disastrous season but farmers are becoming increasingly anxious in Zululand and on the North Coast. The South Coast has enjoyed better conditions.

Peter Sale, general manager of the South African Sugar Association, says the first indications point to a crop of 1.8 million tons compared with last year's 1.6 million tons. "We hope the season will not be like last year, but it is going to be a very close thing," he says.

The drought conditions will place another heavy, perhaps impossible burden, on the 10 000 small growers, mainly blacks. Last year R13 million was paid in loans to farmers who were only able to cut 40 percent of

their normal crop.

It has been a very disappointing summer, says Huletts managing director Dr Kees van der Pol. He said the rains started late, were fine in February but disappeared in March.

An additional problem is the growth of the Eldana borer which thrives in dry conditions.

The dry conditions coincide with a drop in world prices and there appears now to be little chance of the industry reducing the heavy debt burden of R130 million built up in the last four seasons.

Indeed if the rains don't come soon the debt burden will grow even heavier.

» 28 «

Huxley, J. S. and A. C. Haddon. 1936. *The Europeans: a survey of "racial" problems.* New York. Harper and Bros.

ASHLEY MONTAGU

Huxley, J. S. and A. C. Haddon. 1936. *The Europeans: a survey of "racial" problems.* New York. Harper and Bros.

91

III The Concept of Race and the Taxonomy of Mankind

JEAN HIERNAUX

In: Montagu, A (Ed.)
1964 The Concept of Race. New York:
The Free Press. Chapter III,
pages 29 - 45.

Introduction

Race has been given numerous definitions. Many of them are similar in meaning, but several modes of thinking about race still persist. Within a single mode, the formulation of the concept may differ, and some vagueness in it is frequent. Moreover, application of the concept of race by an author to a classification of mankind does not always meet the requirements of his own definition.

I do not intend to review the literature on race and human races. Only a few contributions will be cited as examples. I shall attempt, where so many others have failed, to reach the most sensible and useful definition, and this as a development of a previous paper on the subject (Hieraux 1962) presented at the sixth International Congress of Anthropological and Ethnological Sciences, Paris, 1960. Once this definition is arrived at, I shall endeavor to apply it to current mankind, in other words to apply the concept of race to a classification of mankind into races.

23. Venter, J D
Die Drinkpatroon van Kleurlinge in Kaapland en Natal, Nasionale Buro vir Opvoedkundige en Maatskaplike Navorsing, Navorsingsreeks no. 19, 1965.
24. Verslag van die Kommissie van Onderzoek na Aangeleenthede Rakende die Kleurlingbevolkingsgroep, Die Staatsdrukker, Pretoria, 1974.
25. Williams, R J
Biochemical individuality and cellular nutrition in Quarterly Journal of Studies on Alcohol, 20, 1959.

—00000—

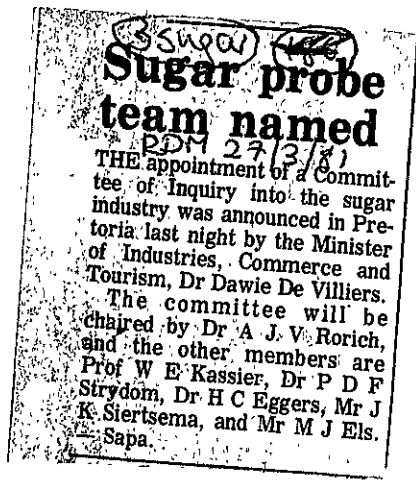

World sugar prices falling

NM 30/4/81

(3-SUCIAR)

LONDON— World sugar prices are falling rapidly as the prospect of shortages, which drove it to peak levels last year, recedes.

Since October, when prices reached a six-year high of £446.50 a ton (then equal to 46 US cents a pound), the market has collapsed.

Dealers blame the combined impact of increased production, subsidised exports, falling consumption and reduced activity by speculators.

In London this week, raw sugar futures fell to their lowest level for a year, with August deliveries quoted at £186 a ton (18 US cents a pound).

The price is now near the 16 US cents a pound level at which export quotas, suspended early last year, must be reimposed under the International Sugar Agreement in order to keep prices within a range of 13 to 23 cents a pound.

The Council of the International Sugar Organisation meets in London in mid-July and will arrange the quotas if required.

Sugar-exporting countries, mainly in the Third World, have been angered by the European Economic Community's resumption of subsidies to clear its surplus of up to 1 000 000 tons.

The British-based publication, *World Sugar Journal*, this month estimated that 2.46m tons would be taken from commercial world sugar stocks to meet demand in 1980-81, but this will still leave end-of-year stocks at about 14.79m tons.

The group of Latin American and Caribbean sugar-exporting countries, Geplacea, now expects the 1980-81 world sugar deficit between consumption and production to be between three and four million tons. — (Sapa Reuter)

Sugar price goes up

Mercury Reporter

CONSUMERS face another round of price increases following the announcement that the sugar price goes up by 13,5 percent today.

Housewives can expect to pay about R2,15 instead of around R1,89 for a 2,5 kg packet of white sugar, according to the managing director of Spar, Mr Brian Beavon.

'It's an absolute disgrace. Hundreds of items on supermarket shelves will be directly affected, not to mention fast foods, bakery items and cool

drinks,' said the general manager of Pick 'n Pay Hypermarket, Mr Martin Rosen.

'We will try to hold our prices for a few weeks if we can buy sugar which is already in the pipeline and therefore not affected by the announcement,' he said.

Mr Beavon said that Spar could probably hold out at existing prices for a maximum of four weeks.

'Food people have been trying to control inflation. It's time the manufacturers played their part,' he said.

Mercury 2/3/86



S. Tribune
24/5/81
38/90

RAIN SAVES CANE CROP

By JACK BRICKHILL, Finance Editor

GOOD rain in the last month came just in time.

Sugar cane growing areas such as Empangeni in the north, which suffered three successive droughts, recorded 100 millimetres. Although the rain fell in a non-growing season when temperatures are low, it is sufficient to keep the cane alive through the winter and provides a firmer base for the next crop.

The general manager of the South African Sugar Association, Peter Sale, says semi-official estimates of the crop have now risen from 1.8 million tons to between 1.8 and 1.9 million tons. The crop may be better than this but it is still early days to make firm predictions. Last year only 1.6 million tons

were produced.

Export quotas imposed by the International Sugar Association will have no effect on South Africa because the level of exports will not come into the scope of the restrictions.

On the present crop estimate and prices Sale says there should be no deficit for the industry this year. The accumulated deficit in the last few years is R150 million.

Dick Ridgway, managing director of Huletts Sugar, says the northern areas were in a critical situation but he flew over the area recently and was pleasantly surprised with the improvement.

The sugar industry's other preoccupation, the eldana borer pest, shows no sign of letting up. There are already five

reports from the mills that have started so far this season, of new infestation on the South Coast.

Last year there were only two reports on the South Coast — at Scotburgh and Margate. The pest, which bores out the cane stalk, has cut production on some farms at Amatikulu on the North Coast by 50 percent. The infestation which started 11 years ago has possibly cut total sugar production by five percent is steadily gaining ground.

Dr Gerald Thompson, director of the Sugar Association Experimental Station at Mount Edgecombe, says that while the eldana does less damage at this stage than the ratoon stunting disease, it is less evenly spread and causes severe damage in certain areas.

ROM 26/5/81
**Brighter
for sugar**

PROSPECTS for South Africa's 1981-82 — May to April — sugar crop have improved after widespread rains in the past few weeks in the Natal sugar belt, says the general manager of the Sugar Association, Mr Peter Sale.

The crop is projected at 1 800 000 tons to 1 900 000 tons, a great improvement compared with earlier estimates of 1 800 000 tons or less.

South Africa's 1980-81 drought-hit sugar crop totalled 1 610 000 tons against 1979-80 output of 2 080 000 tons.

SUGAR

3 SUGAR

Bypassing quotas

FM 29/5/81

The SA sugar industry will not be affected by the recent imposition of export quotas on sugar producers by the International Sugar Association (ISA), which limit the amounts exportable by member states.

The reason for this, according to Peter Sale, GM of the SA Sugar Association, is the severe drought in Natal over the past two years.

This has reduced supplies and diminished the need to export. Sale estimates that this year's crop (May 1981 to April 1982) could be down to about 1.8 Mt. Last year's crop was as low as 1.6 Mt while normal potential is about 2.2 Mt.

The "non-effect" of the ISA quota cuts on SA is illustrated by the export production figures for the last few years — in 1979-80 they stood at 993 065 t, in 1980-81 at 436 496 t and the estimated figure for 1981-82 is between 600 000 t and 700 000 t, still short of the 1979-80 export figure.

Translated into revenue terms, Sale reckons that the drought cost SA about R200m last season and about R100m this season.

But he stresses that had SA been on more or less full production this year the ISA quotas would simply have meant that our sugar stocks could have been replen-

ished. The stocks have been virtually exhausted by reduced production.

The ISA move is part of its strategy to stabilise the sugar price between certain limits. The quotas were introduced last week because the average sugar price over 15-days fell below the trigger price of 16c/lb or about £180/t.

Following bullish prices of over £400/t late last year, prices have sagged, primarily because of diminished world demand. Producers believe that consumers cannot afford the foreign exchange to import sugar and with high interest rates they are not maintaining stocks — but are living hand-to-mouth with regard to sugar.

Demand was adversely affected by the introduction of high-fructose corn syrup which is now being used extensively by manufacturers (particularly of soft drink) instead of natural sugar.

Sugar industry sources expect the quotas, which total about 14.3 Mt, to affect mainly southern hemisphere producers Brazil and Australia because they ship most of their sugar during the second half of the year.

3 sugar

SUGAR

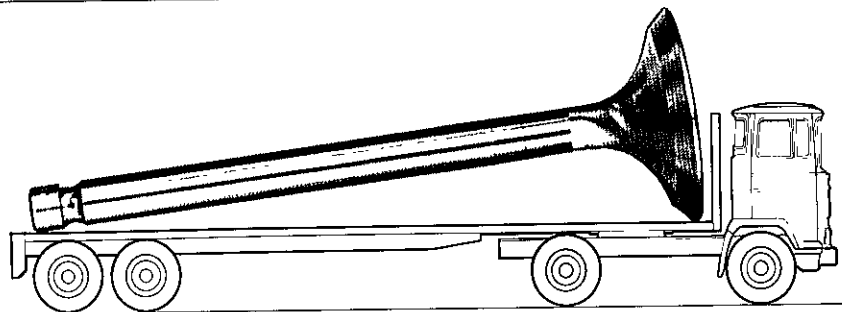
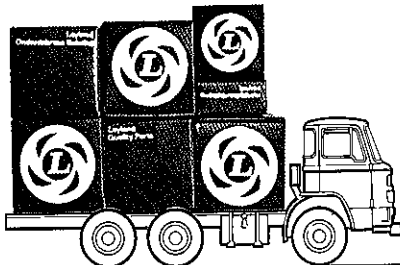
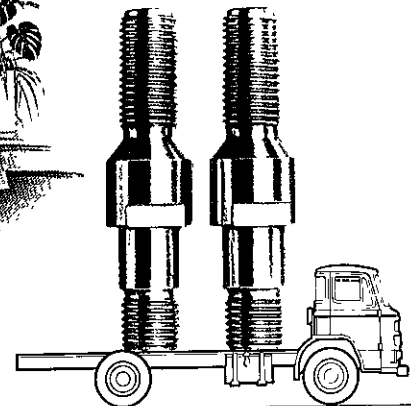
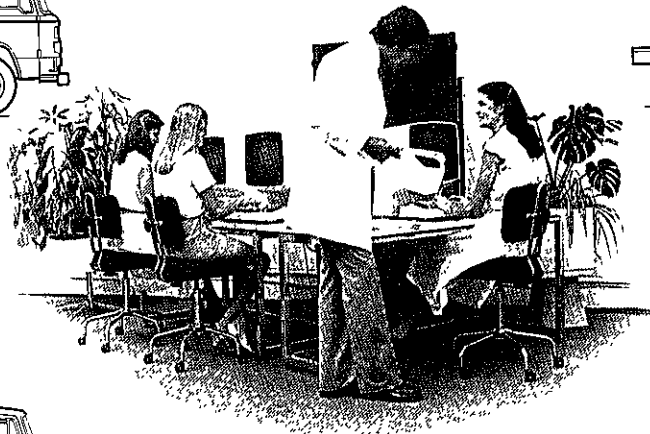
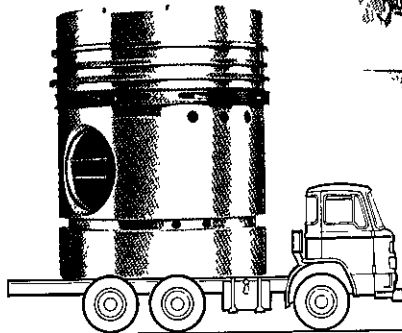
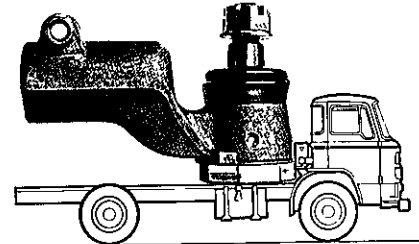
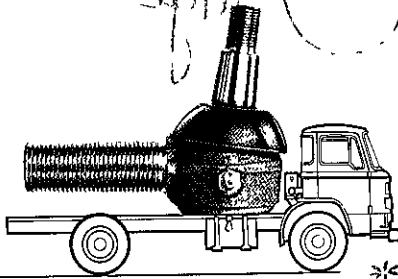
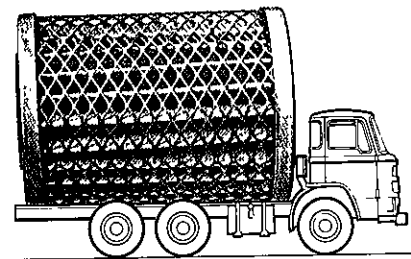
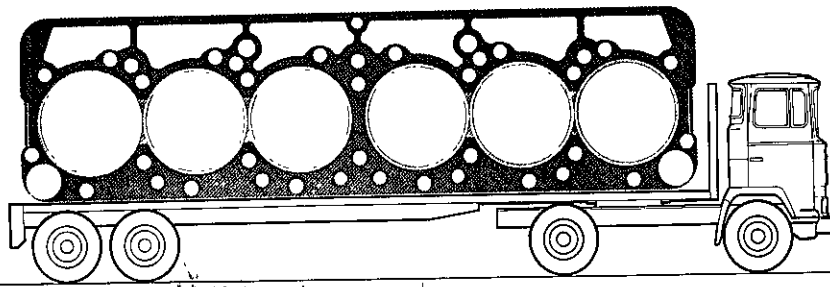

WE'VE GOT OUR HEARTS IN PARTS.

We know that when a professional trucker needs parts he needs them immediately, if not sooner.

So we've installed a computer system, instantly linking our 20 wholly-owned parts warehouses where every one of our factory-trained staff is ready to rush you the part you need at a moment's notice.

That's how you can be sure your Leyland fleet will keep on truckin', with downtime cut to a minimum and profits kept to the maximum.

 **Leyland Trucks**
The Profit Motive

THE LEYLAND DISTRIBUTION NETWORK

TRANSVAAL Ermelo Tel: 01341 2345 Greylingstad Tel: 01392 128 Johannesburg Tel: 011 36-2711 Klerksdorp Tel: 018 8-1041 Krugersdorp Tel: 011 762 1283 Louis Trichardt Tel: 01551 2851 Nelspruit Tel: 01511 2-4195 Pretersburg Tel: 01521 7-4821 Pretoria Tel: 012 55-3811 Tzaneen Tel: 01523 2-1045 Witbank Tel: 01351 2336
CAPE PROVINCE Cape Town Tel: 021 53-3101 George Tel: 0441 3644 Jansenville Tel: 04932 157 Paarl Tel: 0251 2-2076 Plettenberg Bay Tel: 04472 309 Port Elizabeth Tel: 041 41-2141 Richmond Tel: 05752 30 Robertson Tel: 02351 3532 Springbok Tel: 02732 392 Three Sisters Tel: 0020 8121 Uppington Tel: 0541 2811/2 Vryburg Tel: 01451 2391 Wellington Tel: 0251 3-3821/2 Worcester Tel: 0231-5677
OFS AND NORTHERN CAPE Bethlehem Tel: 01431 3881 Bloemfontein Tel: 051 7-7201 Kimberley Tel: 0531 2-4281/4 Senekal Tel: 014352 295 Welkom Tel: 0172 6278
EASTERN REGION Dundee Tel: 0341 2-1916 Durban Tel: 031 42-2181 Empangeni Tel: 0351 2-6811 Estcourt Tel: 03631 4021/2180 Newcastle Tel: 0345 2-9530 Pietermaritzburg Tel: 0331 4-1921 Pongola Tel: 03842 41 Port Shepstone Tel: 0391 2-1136/7
QUEENSTOWN Tel: 0451 3552 BOTSWANA Francistown Tel: 602 Maun Tel: 320 LESOTHO Maseru Tel: 2-2136 SWAZILAND Manzini Tel: 0194 5-2371/2
TRANSKEI Umtata Tel: 0471 3365/6/7
SOUTH WEST AFRICA — NAMIBIA Windhoek Tel: 061 3-5116/7/8

Sugar Survey. Supplement to Financial Mail May 22 1981

INK

The Development Factor



Development which is more than just revising standard products. And to back this up we invest more than half a million Rand in research annually. Research in all varying print areas – letterpress/litho, screen printing, flexo/gravure, metal decorating. The combination of these facilities gives Coates their tremendous analytical backup. In fact, all products are quality-tested in exact simulated print conditions. It is this attention to detail, coupled with Coates' overseas technology and expertise which gives you the plus factor.

IN THE FIELD OF PRINTING INKS WE ARE THE PROFESSIONALS.

**Coates Brothers
(South Africa) Limited**

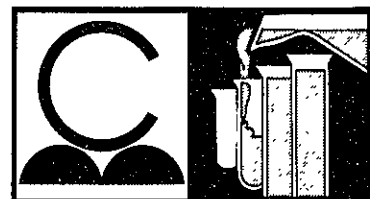

Telephone: Head Office, Cape Town (021) 51-0270; Durban (031) 92-1521; Johannesburg (011) 680-6500; Port Elizabeth (041) 41-2656; East London (0431) 2-6206

SWIFT 1711

ASEA-WEIBULL



ASEA-WEIBULL centrifugals are fully automatic and designed for curing all grades of cane or beet massecuite. They are available in three sizes, 1,220 m x 1,070 m (48" x 42"), 1,220 m x 0,762 m (48" x 30") and 1,270 m x 1,070 m (50" x 42"), with capacities of 1 000 kg, 650 kg and 1 200 kg respectively, for any centrifuging speed between 1 000 and 1 700 rpm. This flexibility, combined with a choice of basket shell material and thickness, means that a centrifugal battery can be built to meet any capacity and duty requirements. The outstanding ASEA thyristor controlled d.c. motor

drive offers many advantages, such as variable speeds and acceleration rates, absence of current peaks minimum power consumption. ASEA-WEIBULL sugar centrifugals have built up a reputation for high quality of material and superb workmanship, giving reliable operation and making for a long life and low maintenance costs. Since 1956 more than 1 200 centrifugals have been delivered to beet and cane sugar factories and refineries throughout the world.

If you want to know more — ask us!

ASEA

ASEA ELECTRIC SOUTH AFRICA LIMITED

P.O. Box 131, Pinetown 3600. Telephone (031) 72-4377. Telex 6-5316 SA

HEAD OFFICE: (012) 79-7020

BRANCH OFFICES: Johannesburg (011) 53-9200. Cape Town (021) 51-9330. Durban (031) 72-4377.

Contents

<i>1980 Year of change</i>	<i>5</i>
<i>Growing bigger.....</i>	<i>8</i>
<i>Development delay</i>	<i>9</i>
<i>Poor sugar</i>	<i>11</i>
<i>Manual rainfall.....</i>	<i>12</i>
<i>Exports down</i>	<i>16</i>
<i>The sugar world.....</i>	<i>17</i>
<i>Terminal to the world..</i>	<i>21</i>
<i>Shipping sugar.....</i>	<i>24</i>
<i>Bulk supply for Reef....</i>	<i>25</i>
<i>A devastating drought..</i>	<i>27</i>
<i>The Eldana disaster.....</i>	<i>29</i>
<i>Worm's-eye view.....</i>	<i>33</i>
<i>Burning for an answer.</i>	<i>37</i>
<i>Spirit of union</i>	<i>41</i>
<i>Drought leads to imports</i>	<i>44</i>
<i>Sugar by the gallon.....</i>	<i>49</i>
<i>Sugar sweet.....</i>	<i>52</i>
<i>The fruit canners</i>	<i>52</i>
<i>Baking sweet bread.....</i>	<i>35</i>

CHARTWELL

Constructs

Design engineering models for the South African Sugar and Process Industries.

Why

To save time and money in the design and construction stage of your plant.

To enable you to see the plant you are getting for your money.

To enable you to train your operators before the plant is built.

That's why

Our staff, including engineering graduates, have years of practical design experience in a wide variety of disciplines.

We could go on and on giving you good reasons to model your new plant (we usually do) but why not write for further details to:

COLIN VENNELL or IAN FRASER

CHARTWELL

CONSTRUCTION (PTY) LTD.
VENTURA HOUSE
242 D.F. MALAN DRIVE
BLACKHEATH
JOHANNESBURG 2195
TEL. 678-7561/2

GRAEME FORBES (DURBAN OFFICE)
DURBAN 48-3255/6

When it's a race against time...

And you're pushing your machinery to the limit and beyond; a breakdown could mean disaster. Take comfort! There's an Oerlikon stockist close by . . .
For all your emergency repairs or continuous production welding needs — use our latest hotline telephone service. Technical advice is available too, if you need it!

Oerlikon and Fontargen arc welding electrodes and brazing alloys for joining and repairing all weldable metals. Robust gas cutting and welding torches. Oxy-acetylene regulators. Transformers and rectifiers. Every type of welding accessory.

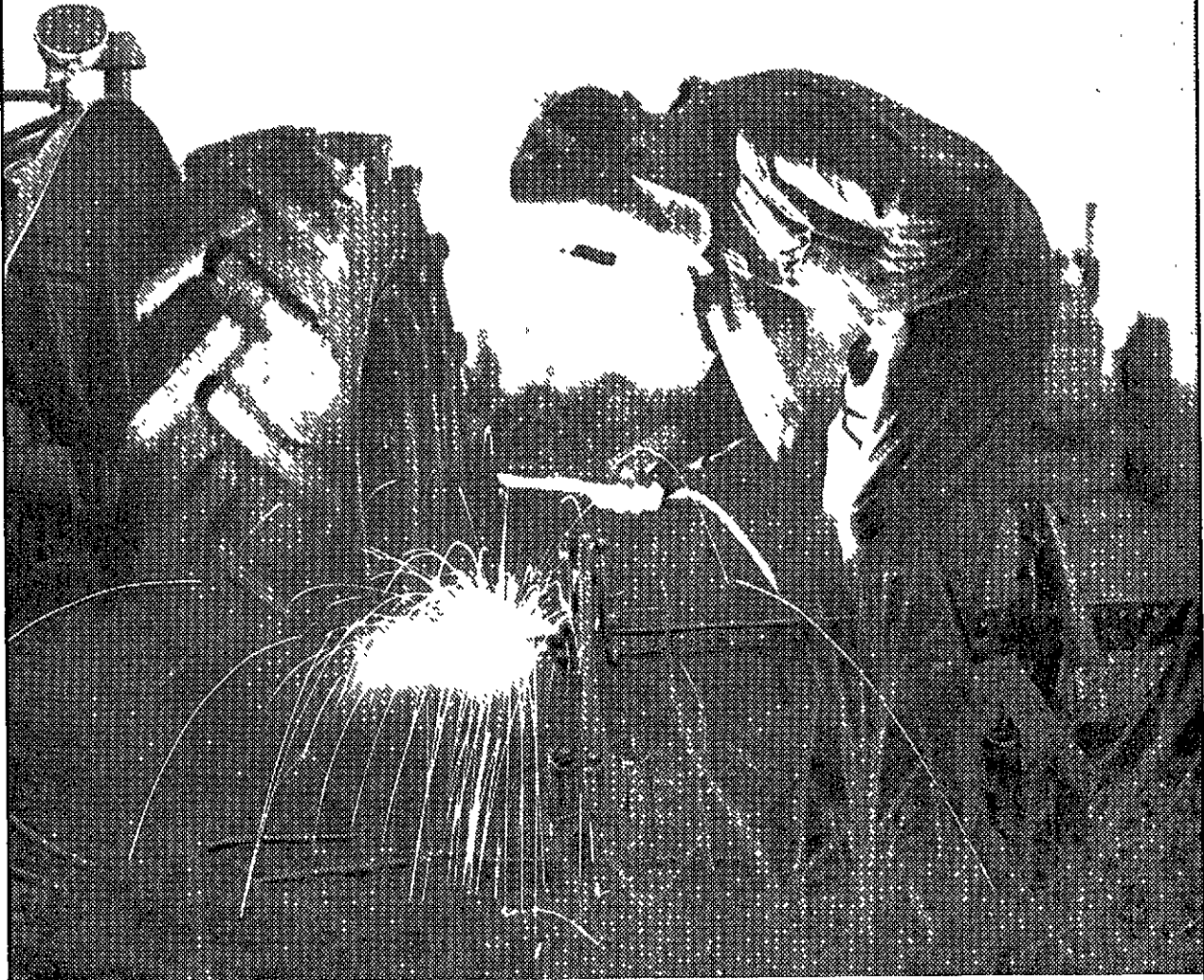

Free literature, wall charts, technical advice available.

BABCOCK ENGINEERING SUPPLIES (PTY) LTD.

formerly/voorheen VINCENT AND PULLAR



☎ (031) 25-5546
— "Electrical"
T 6-2444 DN

☒ 1146, Durban 4000
5 Eaton Road, Congella,
Durban 4001

1980 — year of change



The incestuous sugar industry found two new mothers in a year when a convoluted transaction was completed

The unskilled investor-in-the-street has always had a complex problem in defining the ownership of the sugar kingdom.

But 1980 saw the two industrial giants, Barlow Rand and Anglo American, take a firm hold of more than 75% of the industry.

And, according to both these contenders, it was no line of battle, but a "rationalisation of a very intermixed operation."

August saw the crunch.

C G Smith Investments, controlled by the then unlisted C G Smith and Co (65% owned by Barlows), sold Anglo its 50% share in S & T Investments for approximately R97,6m.

This Smith and Tongaat company held the valuable and controlling interest of 53,5% of the issued share capital of Hulett's Corporation.

The deal gave Anglo joint control of Hulett's with Tongaat. And with Anglo and Amic's 24% share of Tongaat, it was obvious that the control of Hulett's was now firmly in the hands of AAC.

There was also what both Anglo's sugar representative Chris Griffith (of Sigma fame) and Barlow Rand's Warren Clewlow, described as "a friendly and convenient deal."



**Griffith (left) and Clewlow . . .
"a friendly and convenient deal"**

Hulett's sold Barlows the packaging interests of Hypack and Containem for a "reasonable" R39m. And, as Clewlow says: "We at Barlows had to introduce to Smith a 55,4% interest in Nampak, the packaging group, so that shareholders would go for the takeover proposition."

On the periphery, there was an agreement to transfer from Hulett's to C G Smith a sucrose equivalent of 50% of the quota of the Mt Edgecombe mill not later than the end of the 1985-1986 season — for a sum to be negotiated. The result of this would be a further development of the Illovo mill's potential, according to Smith Sugar executive director Tony Norton.

Hulett's also allowed Smith Sugar an option of 35% of its Zimbabwe Triangle sugar interest to be taken before March 31 of this year. This option has not been exercised.

At the end, the ironing out was epitomised in the reconstruction of the Smith Group. Smith Investments ceased to be the listed company, with C G Smith Sugar taking its place. The final name of the new giant will be C G Smith Ltd.

The other flash in August was the revealing of the mystery buyer of R27m worth of farms in the Umfolozi mill's area as Anglo. This gave the corporation 33% of the cane supply to the Umfolozi Co-op at Mtubatuba mill, and representation on the board.

There may have been a shortage of rain in the sugar industry last year, but there was no shortage in the flow of cash.

Royal Swazi Sugar Corporation

SIMUNYE REFINERY

TAYLOR in South Africa
was awarded the total turnkey contract for
the automatic process control systems*

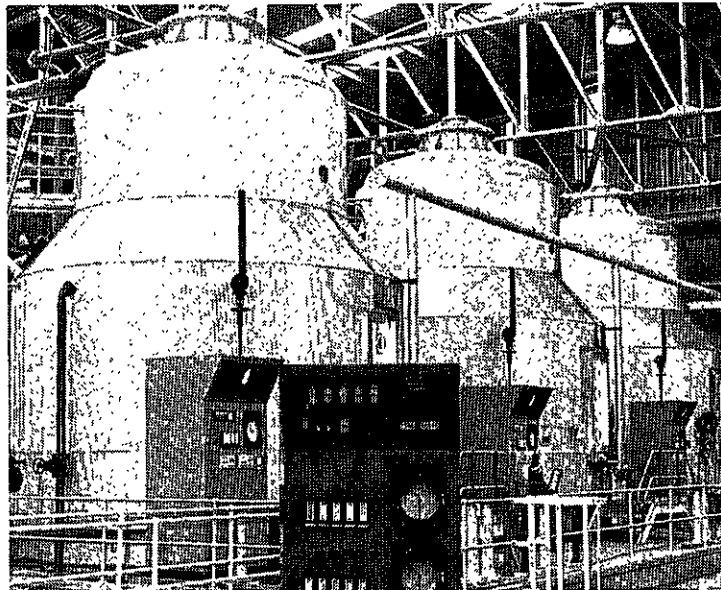

Taylor Instrument's local expertise and the help of its Euro-Africa division industry specialists in the sugar refining industry led to the successful commissioning of the plant.

For further information contact:

TAYLOR INSTRUMENT (PTY) LTD., P.O. Box 9895, Johannesburg, 2000.
Telephone (011) 618-3340

* **Main contractors and Consulting Engineers: Tate & Lyle Ltd.**
Photographs by courtesy of Royal Swazi Sugar Corporation.

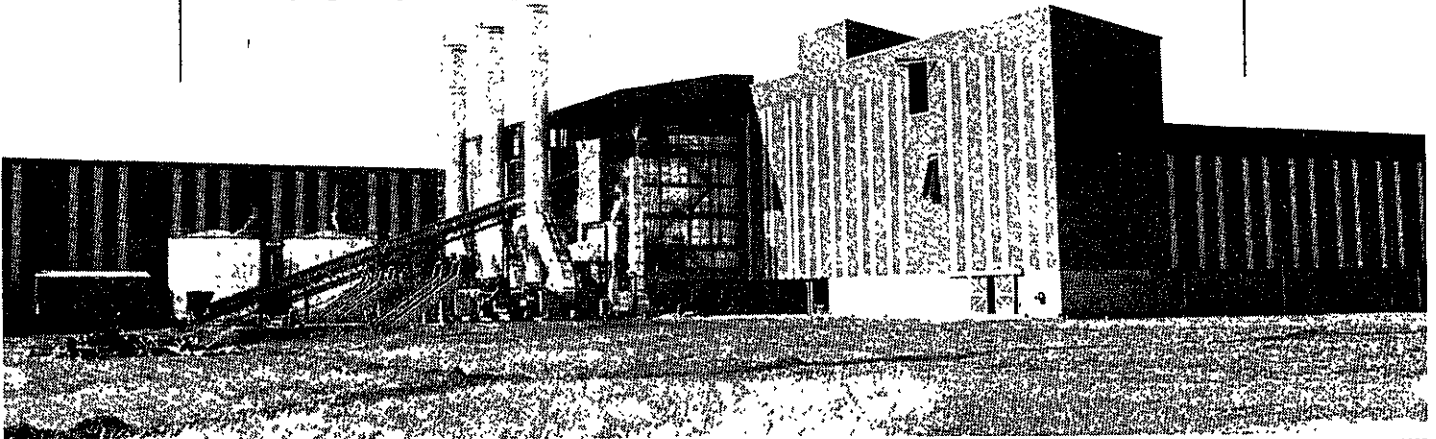

1106

NOW! 40% of all tractors on the North Coast* are John Deere!

1975=19% • 1976=27% • 1980=40%

*40% of all tractors registered in the NDW, NJ, NM and NT areas are John Deere. In 1976 the figure was 27% and in 1975 it was 19%.

Proof of John Deere reliability and suitability in the sugar industry.

Authorised dealer.

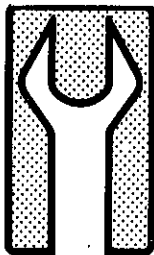

Farmers Services
(Pty) Ltd

Tel. 032232-137, 42, 43
Salt Rock Road
Umhlabi

Tel. 035412-861
21 Bevis Crescent
Eshowe

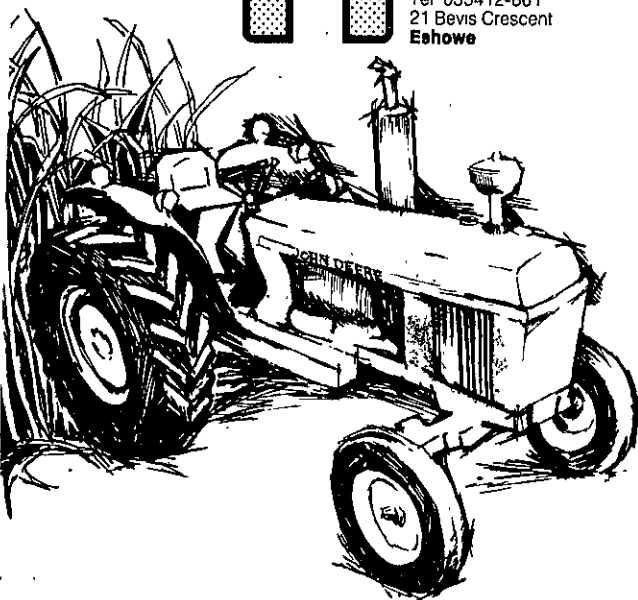

THE AIR SURVEY CO. OF AFRICA LIMITED

AIR SURVEY HOUSE,
10 CALAIS ROAD,
DURBAN.
P.O. BOX 2836, DURBAN.
PHONE: 317808



TELEGRAPHIC ADDRESS:
"BIRDSBURG"

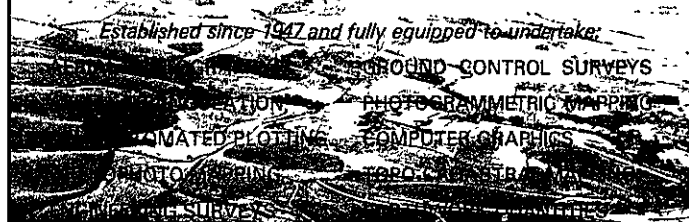

PROFILING AND DIGITAL
TERRAIN MODELS

SUGAR CANE AND TIMBER
SURVEYS

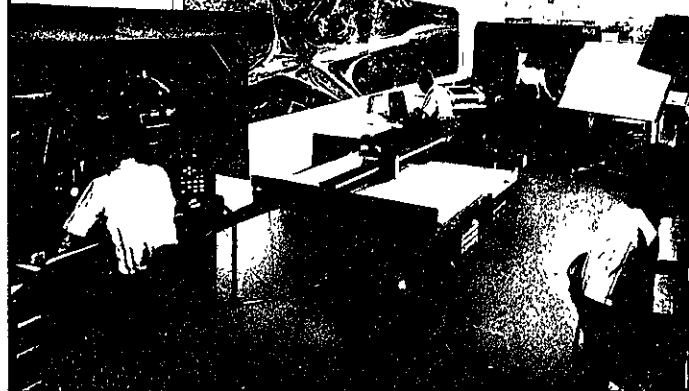

We have been associated with the South African Sugar Association since the first sugar industry aerial survey was carried out in 1954. We have recently completed the 1977/1979 industrial survey of the entire sugar belt extending from the Transvaal areas of Malelane and Pongola in the north over the whole coastal and midland areas of Natal to Port Edward in the south. As a continuous service to the S.A.S.A. we are up-dating these plans as and when this becomes necessary due to replanning of farms, establishing of new cane areas etc. In addition to the maps, a hard copy of the computer records held for each sugar quota is provided and this data bank is continually up-dated for the benefit of the Sugar Industry Central Board. We continue too to provide the S.A Sugar Experiment Station with the necessary maps for farm planning purposes as these are required.

As the costs of production of sugar cane increases with escalation in prices of fuel, fertiliser, labour etc so the need for accurate maps becomes increasingly more important and over the years numerous aerial surveys have been carried out for individual growers to assist them in their farming operations.

Growing bigger

Smith's Sugar plans to spend more than R50m developing its milling infrastructure

C G Smith's Sugar is the largest sugar producer in SA and still growing.

With an increased market share of 40,6% last season (1979-1980 — 40,4%), the company has validated its nickname of "the big cash cow."

Over the years, the operation has built up its cash coffers and has had virtually no debts to speak of.

Talking about Smith's errors, which are minimal, the only flaw was an involvement by the old controlling company, C G Smith & Co Ltd (unlisted). That was a 50% share they took in the Stanger Pulp and Paper Mill under the autocratic, but beneficial, rule of Jack McGough. This part of the R76m investment was eventually sold back to joint-partners, Reeds, for the royal sum of R1. But when he retired in 1980, the company had certainly benefited from McGough's brilliant cash management.

Apart from that one failure, the latest development plans should increase its cash gathering, without any risk.

Tony Norton (formerly a merchant banker), who took over as chief executive of Smith's Sugar from Frank Jones, is happily looking at pushing up the 1979-1980 after-tax profit of R20,7m, as the group's sugar interests are refined over the next three years.

He views the company operations in the same way as he looked at banking interests. "Sugar," he says, "has a lot of dimensions which make it a very interesting, but specialised, investment."

And Warren Clewlow, the former Natalian who heads up the mother company's involvement in Smiths, agrees.

"This was Barlow Rand's first involvement in sugar," he said. "But, tied in with their carpet, textile and packaging sectors, we are looking for a positive investment in Smiths for future growth."

On the development side, Smiths is looking for both an enhancement of its cane growing, and more especially, its milling production.

On the growing side, Smiths wants expansion. As Frank Jones, now chairman of Smith Sugar says: "If the Committee of Enquiry gives the green light for expansion, we could grow extra lands in cane without any difficulty. This would, in time, give us an additional annual sugar tonnage."

Jones, who is also chairman of the Sugar Millers' Association, is emphatic that there will be benefits for both the milling and growing sections.

"There is undoubted potential to in-



Tony Norton . . . 'interesting but specialised, investment'

crease the cane supplies to existing mills, after which consideration could be given to the establishment of new mills to serve new cane growing areas," he says.

He also points to the need for early action to strengthen the SA industry's



Frank Jones . . . 'potential to increase'

position as a leading world exporter.

The milling development is well formulated, despite a run-down in the industry, due to International Sugar Agreement (ISA) restrictions on production totals and the miserable effects of the drought. Yet the lack of rainfall was less problematic for Smiths, thanks to the geographic position of its growing areas (mainly in the south and midlands of Natal, and the south-eastern Transvaal).

Smiths intends to invest a substantial amount from its cash reserves in modernising its already efficient milling outfit.

Capacity utilisation is to be increased at all its mills, except at the Gledhow plant, which has already been expanded.

In the next three years, the Sezela mill is to have its capacity increased in a R21m expansion programme. It will lose its refinery at the end of the 1981-82 season, but a bigger unit is included in the plans for Noodsberg, which, along with Pongola and Gledhow, will more than comfortably cope with the group's white sugar requirements.

The Noodsberg refinery will be commissioned during 1982-1983, with a design capacity of 150 000 t. Cost will be R14,5m for the plant, with an extra R500 000 for housing needs. This again can claim to be the largest in SA and follows a similar successful plant set-up in Mauritius.

Pongola faces a programmed expansion of R1,3m. In 1982-83 the refinery will be able to handle 95% of the plant's output, as opposed to its present 70%. And the raw house will be modified to improve its thermal efficiency. Under normal circumstances, this will reduce the need for coal as a supplementary fuel.

Illovo, which Norton describes as "a quite developable adolescent," will act as the consolidator of the brown sugar pre-packing, previously done by Pongola and Umzimkulu. Added to that there is a R10,4m expansion of the mill's capacity. This will uprate the production from 150 t/hour to 200 t/hour.

The other incidental (only on the scale of Smith's enlargement) developments are 4 000 m² warehouses at Noodsberg and Gledhow and a 2 000 m² unit at Illovo.

The big development is the capacity increase at the south coast mill of Sezela.

This will uprate the milling tonnage to 450 t/hour by 1990-1991 as opposed to its present capacity of 350 t/hour. With a government decision to allow the mill growing area to expand by a potential 5 140 ha (a Smith's hope), the eventual capacity required would hit the 500 t/hour level. This possibility is included in the expansion plans, which have certain flexibility.

Inflation is expected to boost the end price of the planned expansion by R3,5m.

There is large-scale irrigation with minimal labour

Rainboom now provides the most economical and efficient irrigation for large-scale crops and grazing.

Large Area

The travelling Rainboom RB88 can irrigate up to 42 ha per month with a precipitation of 150 mm.

Saves Labour

Even stationary models can be moved from point to point in an average of only 10-15 minutes and from lane to lane in about 30 minutes.

Versatile

- Beam height is hydraulically adjustable to suit wind and crop conditions.
- Models available for high (550kPa), medium (350kPa) and low pressure (150kPa).
- Pipe shelves for movable pipelines built into all stationary models.
- Available in models ranging from fully self-propelled with water and/or own engine power, for mounting on tractor, or to be drawn by tractor.

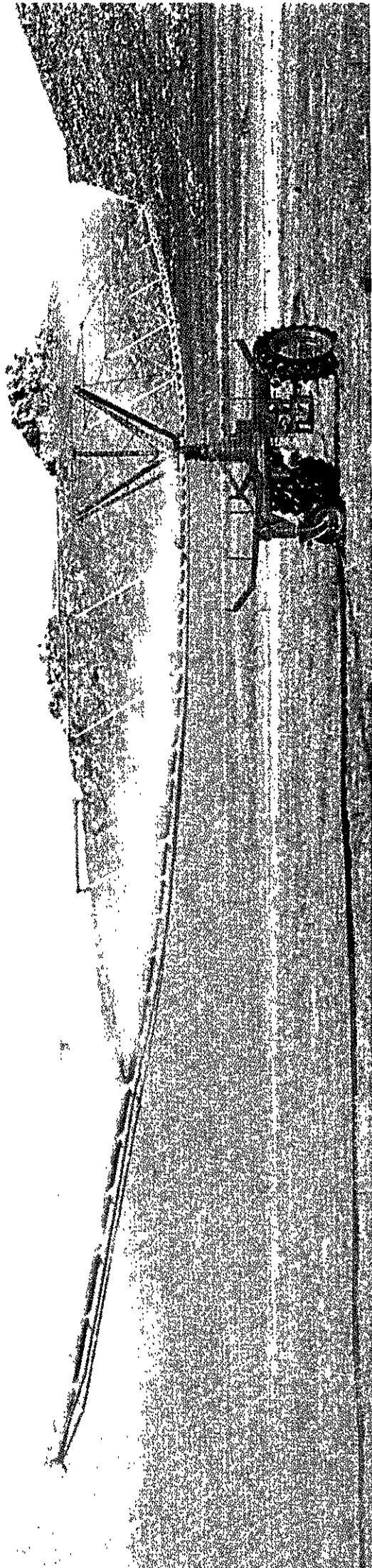

AGRIPLAS (PTY)LTD and
AGRIPLAS WRIGHTRAIN (PTY)LTD

South African leaders in irrigation

Telephone (021) 97-2571 • Glucose Road PO Box 261 • Bellville 7530

ROBERTSON – PO Box 377, Tel.: 3151 NELSPRUIT – PO Box 1047, Tel.: 25236

PINETOWN – PO Box 256, Tel.: 72-8263 PIETERSBURG – PO Box 332, Ladanna, Tel.: 74804

PIETERMARITZBURG – 14 Winston Ave., BENONI – PO Box 9061, Brentwood Park,

Tel.: 41-072 Tel.: 973-3718

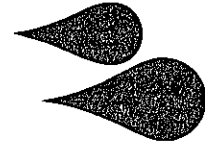

The well proved Rainboom is now available in 3 models with 42 different combinations

RB 88 with 88m beam

RB 63 with 63m beam

RB 45 with 45m beam

Telephone or write for complete information on the versatile Rainboom for large-scale irrigation. Our staff of irrigation specialists serves agriculture throughout South Africa. Our irrigation systems include preliminary investigation, feasibility studies, costing and implementation. They are backed by complete guarantees and comprehensive maintenance.

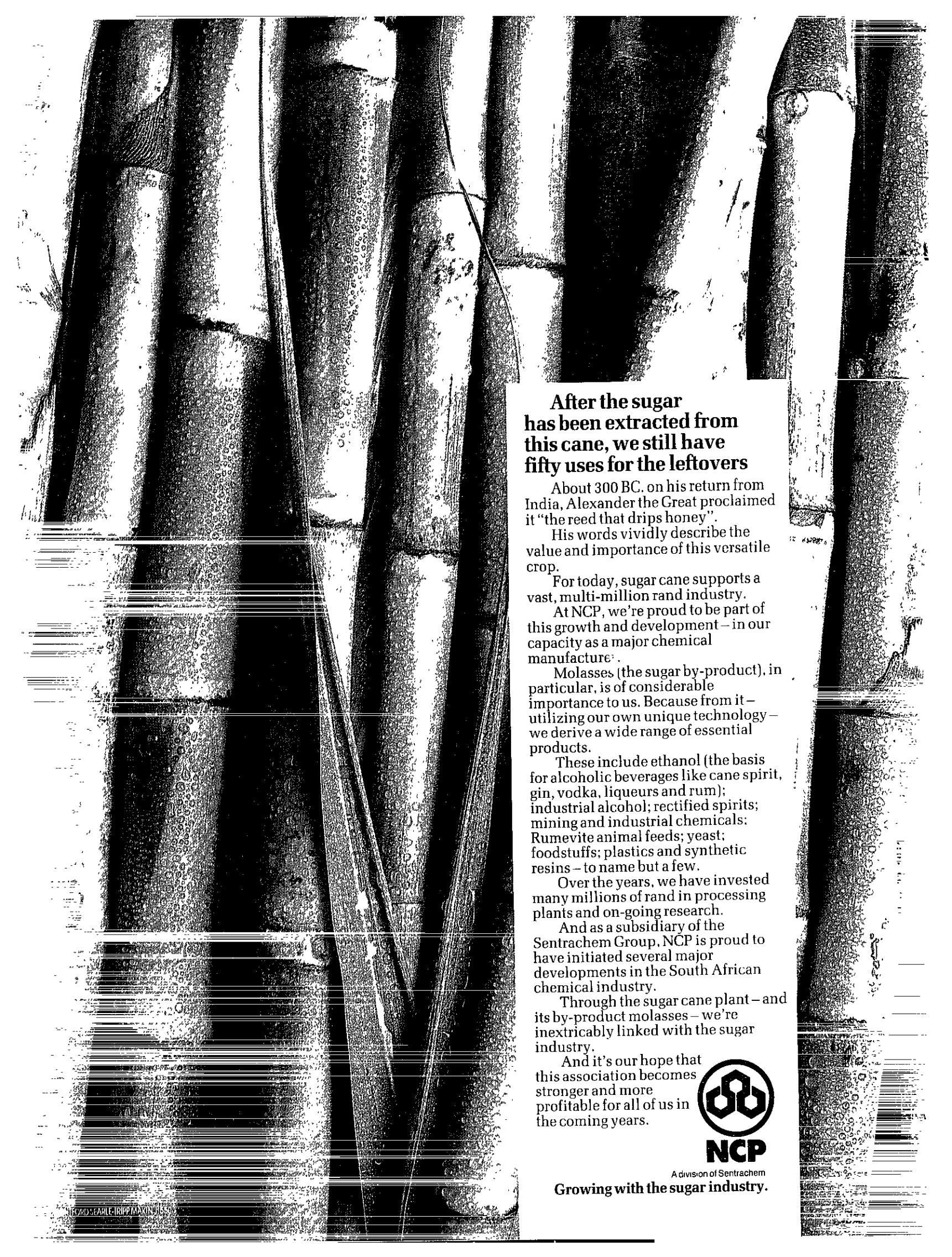

**After the sugar
has been extracted from
this cane, we still have
fifty uses for the leftovers**

About 300 B.C. on his return from India, Alexander the Great proclaimed it "the reed that drips honey".

His words vividly describe the value and importance of this versatile crop.

For today, sugar cane supports a vast, multi-million rand industry.

At NCP, we're proud to be part of this growth and development – in our capacity as a major chemical manufacturer.

Molasses (the sugar by-product), in particular, is of considerable importance to us. Because from it – utilizing our own unique technology – we derive a wide range of essential products.

These include ethanol (the basis for alcoholic beverages like cane spirit, gin, vodka, liqueurs and rum); industrial alcohol; rectified spirits; mining and industrial chemicals; Rumevite animal feeds; yeast; foodstuffs; plastics and synthetic resins – to name but a few.

Over the years, we have invested many millions of rand in processing plants and on-going research.

And as a subsidiary of the Sentrachem Group, NCP is proud to have initiated several major developments in the South African chemical industry.

Through the sugar cane plant – and its by-product molasses – we're inextricably linked with the sugar industry.

And it's our hope that this association becomes stronger and more profitable for all of us in the coming years.



NCP

A Division of Sentrachem

Growing with the sugar industry.

But the group is pleased to dig into its resources to "demonstrate our boundless confidence in the SA sugar industry and our own group's prominent position in it."

as Frank Jones, almost smugly, expresses it.

Jones also has a smile on his face when he describes the Barlow Rand/C G Smith

Ltd conglomerate as "a newly reconstructed group, which, in terms of capital employed, ranks among the top six industrial companies listed on the JSE."

Development delay

Hulett's plans for a R120m mill to replace two old-timers are being re-investigated

On August 1 last year Hulett's announced its intention to build the largest single sugar mill in SA.

The new Felixton mill was intended to replace the ageing Felixton and Empanjeni plants, which had become unprofitable.

In comparison to the total output of 235 000 t of sugar a year from the old operation, the new mill would be able to produce 370 000 t at a milling rate of 600 t an hour.

Dick Ridgway, MD of Hulett's Sugar, described the project as "designed to have both built-in spare capacity and facilities for easy expansion. This is to cope not only with increasing cane supplies from existing sources, but also those arising from the potential large scale development of cane growing in KwaZulu."

But since the take-over of Barlow's interest in Hulett's by Anglo on August 4, the plan is being re-examined.

Chris Griffith, one of the executives who represents Anglo on the Hulett's board, described the overall reasoning for the delay as "not rushing the fences."

"Before Anglo is prepared to confirm this previous commitment, we wish to

examine with Hulett's management the merits of all possible alternatives."

Griffith is careful to stress that this is no criticism of Hulett's management.

In fact, a number of the top men in the industry describe Ridgway as "one of the bright young men in the business." And it is fully expected that he will take over the chairmanship of the Sugar Association from Ian Smeaton in the near future.

"Anyway," says Griffith, "the anticipated timing delay is not significant, thanks to the drought in the area having reduced production."

"It will probably be a few years till the growing tonnage reaches normal levels."

Despite the recommendation from Anglo for the delay, it has not interfered in the day-to-day operation of Hulett's, according to Griffiths.

"As a group we have generally worked on a decentralised basis," he said. "We intend to have no line management through the company. The operation will be entirely handled by Hulett's."

"I do sit on the executive committee, but that is only to be in a position to influence the policy and strategy, not to control the running of Hulett's activities."

Like the other groups, Hulett's has plans for expanding its cane growing and sugar production.

Ridgway is looking at a development of 2 000 ha a year in Kwa-Zulu.

"There is" he says, "a very substantial undeveloped area (20 000 ha) where cane can be grown under natural rainfall, without the need for irrigation."

"We want to develop the area. Our plan is to procure medium- to long-term development loans in the same way as the industrial Small Growers' Financial Aid Fund (of which Ridgway is chairman). In addition, we will provide technical expertise. This will be handled by a separate development company."

"The system of land tenure in KwaZulu (common land) presents a difficulty. But we are working in close collaboration with the tribal chiefs and the KwaZulu Department of Agriculture, and hope to establish farm units on a viable basis. Chief Gatsha Buthelezi has, in fact, made promising statements on cane farming in his Kwa-Zulu Development Plan."

Dr Kees van der Pol, Hulett's group



Ian Smeaton . . . Dick Ridgway his successor?

MD, says: "Growth in money terms is significantly influenced by increased efficiency, and considerable improvements have been achieved. We are, however, very conscious of our social responsibilities."

The Sugar Division's performance is disappointing this year, mainly due to the effects of drought and, to a lesser extent, Eldana borer. Income after taxation in 1978-1979 was R11 920 000 and in 1979-1980 it was R10 471 000. But there has been a growth in the other sections of the Corporation, particularly Hulamin.

Hulett's have not yet announced their results (unlike Tongaat's early unaudited statement). But the directors' statement in the November interim report that Hulett's earnings will be roughly the same as last year's 87c, indicates that an unchanged 32c final dividend can be expected.

The sugar section's reduced performance is indicated by its share of the industry. In 1978-79 this was 33,91%. In 1979-1980 it had fallen to 30,26% and last season this tumbled to 27%.

The drop is entirely due to the two year drought in Zululand, where three of Hulett's five mills are situated, and to the severe damage caused to the cane crops by Eldana borer. This was particularly prevalent in the Empanjeni and Amatikulu areas where some farms were 100%



Kees van der Pol . . . growth in increased efficiency

the SULZER blade story

part 1 Steam Turbines

HERE AT SULZER WE'VE BEEN MANUFACTURING ROTARY BLADES TO OVERSEAS STANDARDS FOR SOMETIME NOW.



OUR MARKET STREET PREMISES HAVE THE MOST **UP-TO-DATE MACHINERY**. SO WE CAN COPE WITH JUST ABOUT ANY BLADE APPLICATION IN THE **SUGAR INDUSTRY**.

SULZER BROS.



OUR FACILITIES COVER A WIDE RANGE OF BLADES FOR STEAM TURBINES.

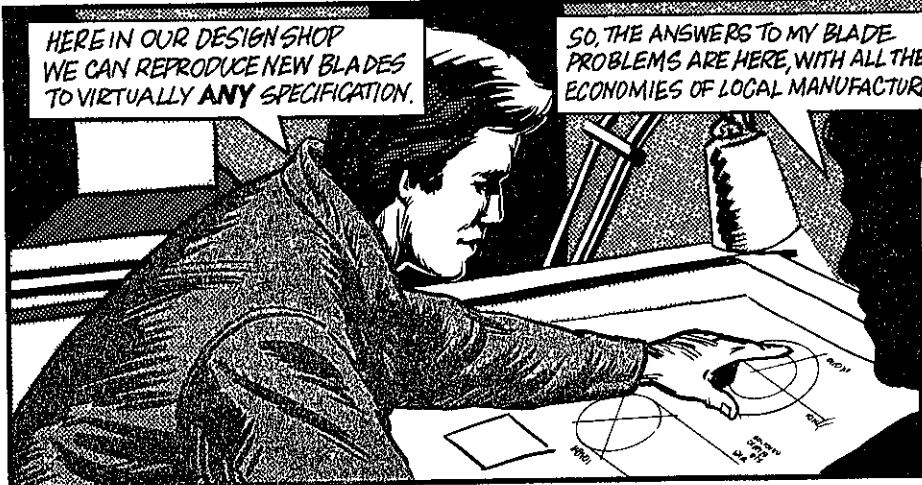

HERE IN OUR DESIGN SHOP WE CAN REPRODUCE NEW BLADES TO VIRTUALLY **ANY SPECIFICATION**.

SO THE ANSWERS TO MY BLADE PROBLEMS ARE HERE, WITH ALL THE ECONOMIES OF LOCAL MANUFACTURE.

SO THERE'S NO REASON FOR ME TO LOOK ANYWHERE ELSE FOR **PRECISION BLADES**

EXACTLY! OUR KNOW-HOW IS YOUR GUARANTEE OF PERFECTION!

THERE IS CAPACITY AVAILABLE RIGHT NOW TO OFFER EXCELLENT DELIVERY TIMES FOR STEAM TURBINE BLADES.

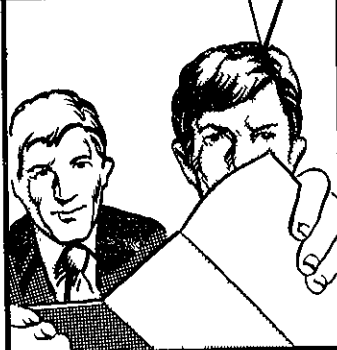

WHAT'S MORE, EACH BLADE GOES THROUGH THE MOST **STRINGENT QUALITY TESTS!**



THONG!



SULZER SULZER BROTHERS. GAS COMPRESSION DEPARTMENT.

260 Market Street, Jeppestown, P.O. Box 930, Johannesburg, 2000 Tel. 618-4125.

Heeley Bates Goodship Δ May 8540

affected.

Says Ridgway: "Our production prospects for next year are difficult to judge. What rain there was came very late in the

season. Although we will start milling with mature cane, it may be necessary to close and re-open certain mills in the area to enable younger cane to reach maturity.

"This, tied in with a lower sucrose content and purity in Eldana infested cane, is bound to see our sugar tonnage sitting at a relatively low level again."

Poor sugar

The Tongaat Group has substantially improved its forecast earnings, but the sugar division has been a disappointing contributor

The Tongaat results, announced in late April, implied a healthy financial position.

But the bulk of the 68% rise in group taxed profits, from R17m to R28,5m for the year to end March, was mainly a result of the performance of the divisions other than sugar.

The decline in this division was significant, although its misfortune was shared by the other major sugar producers. In financial 1980, sugar accounted for 31% of the profit compared to 1979's 34%. In the last season (1980-1981), it had slumped to "below 20%," according to group financial director, Ted Garner.

The cause of the drop in sugar production was the drought. And the figures for tonnage produced showed this substantial decline.

The 1978-1979 total of 210 038 t climbed to 217 573 t in 1979-1980, but then came the abysmal drought slump to 140 604 t for the 1980-1981 season.

As with the other producers, this position is not likely to improve to normal capacity for at least two years, because of the slow growth period of sugarcane.

But Garner says the position is "far more hopeful than a year ago."

If this optimism is measured against

the anticipated crop for 1981-1982, the sugar division's profit contribution could show a climb from the depths of this year — provided the rain-dances in Natal raise the poor rainfall statistics of the first



Dr Geoff Cleasby . . . 'hard hit by the drought'

quarter of this year to a more acceptable level.

Dr Geoff Cleasby, the deputy group managing director, says: "The fruits of our latest developments in KwaZulu, and the earlier expansion and acquisitions referred to by chairman Chris Saunders in the 1980 company report, have been severely restricted as a result of the drought conditions experienced in 1979-1980, and more particularly in 1980-1981.

"The cane areas were particularly hard hit by the drought and it would consequently be misleading to attempt to quantify the effects of additional throughput (from the extended KwaZulu cane farms) other than to say that the extra cane was of special consequence, because of the low level of utilisation of factory capacity."

That level of utilisation was a disturbing 35% down on the record-breaking total of 1979-1980, achieved despite the start of the aridity.

The extension in KwaZulu is a socially important aspect of the Tongaat operation.

This project, started in 1977, is tied in with the Sugar Association's Small Cane Growers' Financial Aid Fund and the Corporation for Economic Development.

The group set up the Sukumani Development Company to promote agricultural and business enterprises in the Ndwedwe district, an area inland of the Tongaat Mill. The supply of the necessary equipment and technology increased the area's

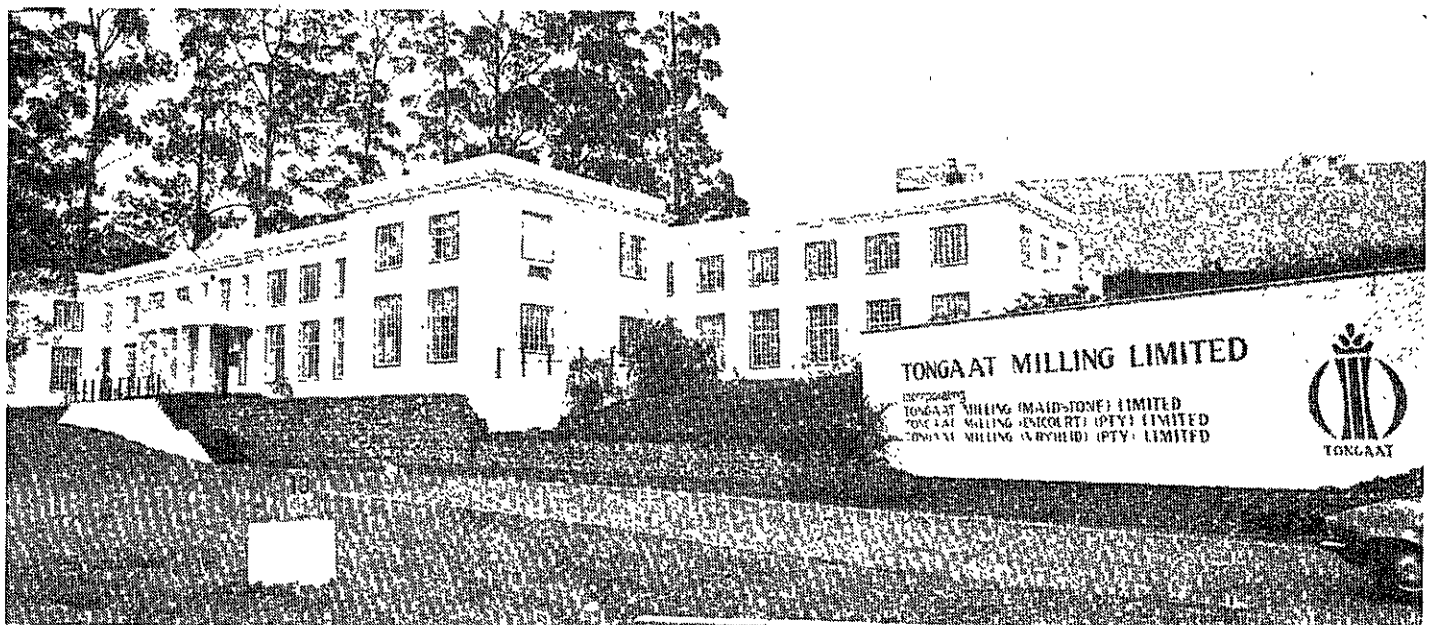

productivity from 25 000 t of cane in 1973-1974 to 197 000 t in 1979-1980.

This is largely responsible for creating the additional net revenue of approximately R2m a year for the black farmers in the area. Before this, the production of cane was regarded as purely subsistence agriculture.

Ndwedwe now supports 3 650 black cane growers (178 in 1974) who farm more than 5 000 ha of cane. Under normal weather conditions, they can produce well over 200 000 t of cane a year. At the end of the 1979-1980 season, the Zulu contractors delivered over 100 000 t of cane. The balance was cut by the local farmers associations, with the in-field transport being done by Sukumani.

The current season's cane throughput is only 65% of the 1979-1980 tonnage. But despite this, and a corresponding drop in

sugar production, there are hopes for the next two seasons.

From the group's four-year plan, the estimates of production indicate that the 1981-1982 crop will improve to 85% of the 1979-1980 level.

Recovery from the drought will take time as the effects are worked out of fields when the two-year-old cane is harvested. If, after the dry first quarter, normal weather conditions prevail for the rest of the growing season, the crop is expected to yield 180 000 t of sugar for 1981-1982.

The improvements in cane production will come from KwaZulu. The indications are that the 1981-1982 estimated total of 236 800 t of cane will rise to 366 000 t in the next two seasons. Miller-cum-planter operations should rise by 130 000 t in the same period.

With only one mill in its stable, Tongaat is not on the same large development scale as Smiths' Sugar. No developments or acquisitions have been made since 1979-1980 and no major developments are contemplated in the short-term. But the capacity of the factory will be upgraded.

This will enable it to increase cane throughput, which is expected to reach a record level of 2 250 000 t by the 1983-1984 season. This projection is well up on the 1 911 460 t of the 1978-79 season, which can be described as normal in comparison to the drought-affected 1980-81.

Apart from improving time efficiency, there will also be a number of technical replacements and improvements. The mill's crystallisers, evaporators, clarifiers and pans are due to be improved and it is probable that a new boiler will need to be installed in the medium term.

Manual rainfall

The Eastern Transvaal had a happy 1980-81 season compared to the woefully poor Natal results

The sugar industry in the Eastern Transvaal did not suffer from the drought which hit the Natalians in the past season.

This is mainly ascribable to the different geographic location, which saw a drop of only 10% in the season's rainfall. And that had no significant effect on the cane crop.

The growing area has, in any case, a full system of irrigation, and is not entirely dependent on the natural rainfall.

Thanks to this and the efficient performance of the mill, Transvaalse Suikerkorporasie Beperk (TSB) managed to beat production levels of previous seasons.

At the end of a season during which most other companies reeled under the effects of what was described as "the dreadful drought", TSB has every reason to smile.

But capital costs of essential irrigation are high. Between R1 200-R2 000/ha. Operating overheads vary from grower to grower. But irrigation constitutes a substantial part of the overall growing cost.

This is one of the main distinguishing features between TSB and the rest of the SA sugar industry, where irrigation is limited.

Despite the high cost, irrigation has an important advantage. Unlike Natal, where the average growing period is 16-18 months, eastern Transvaal can cut cane at around 12 months.

About 90% of approximately 19 000 ha of cane in the TSB mill area is under dragline and conventional overhead spray. The

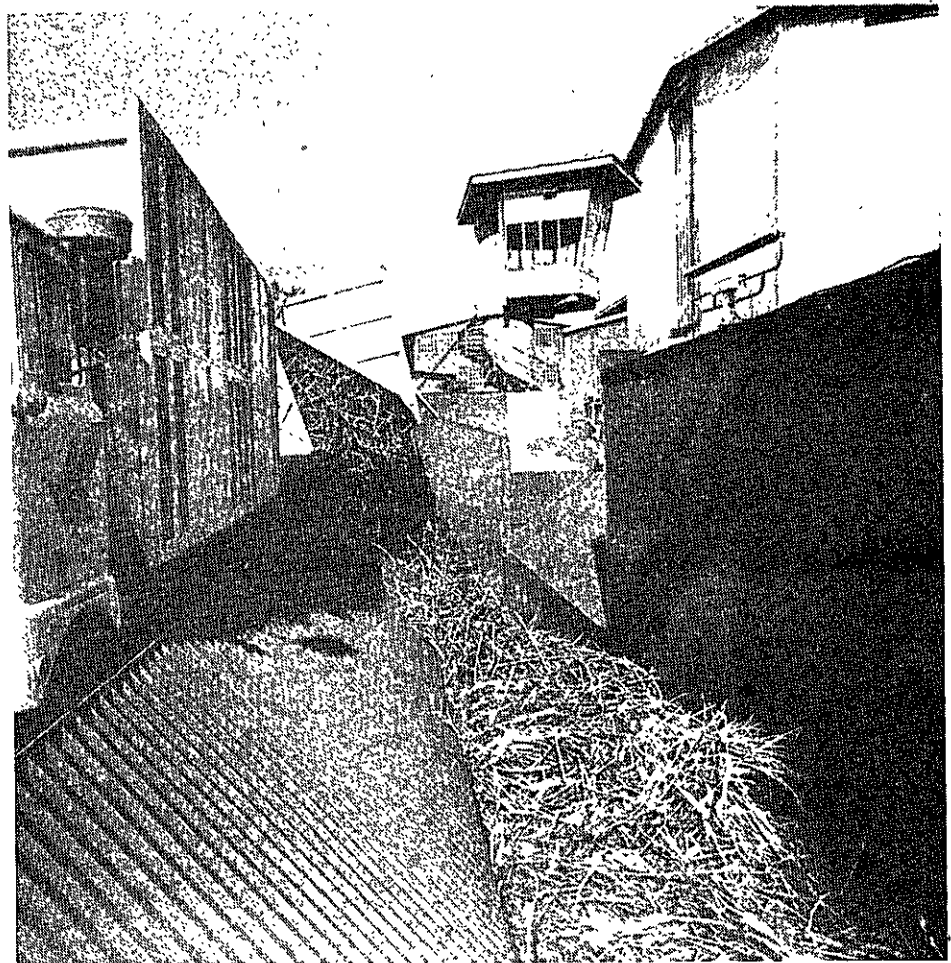

Malelane Mill is improving its cane intake facilities

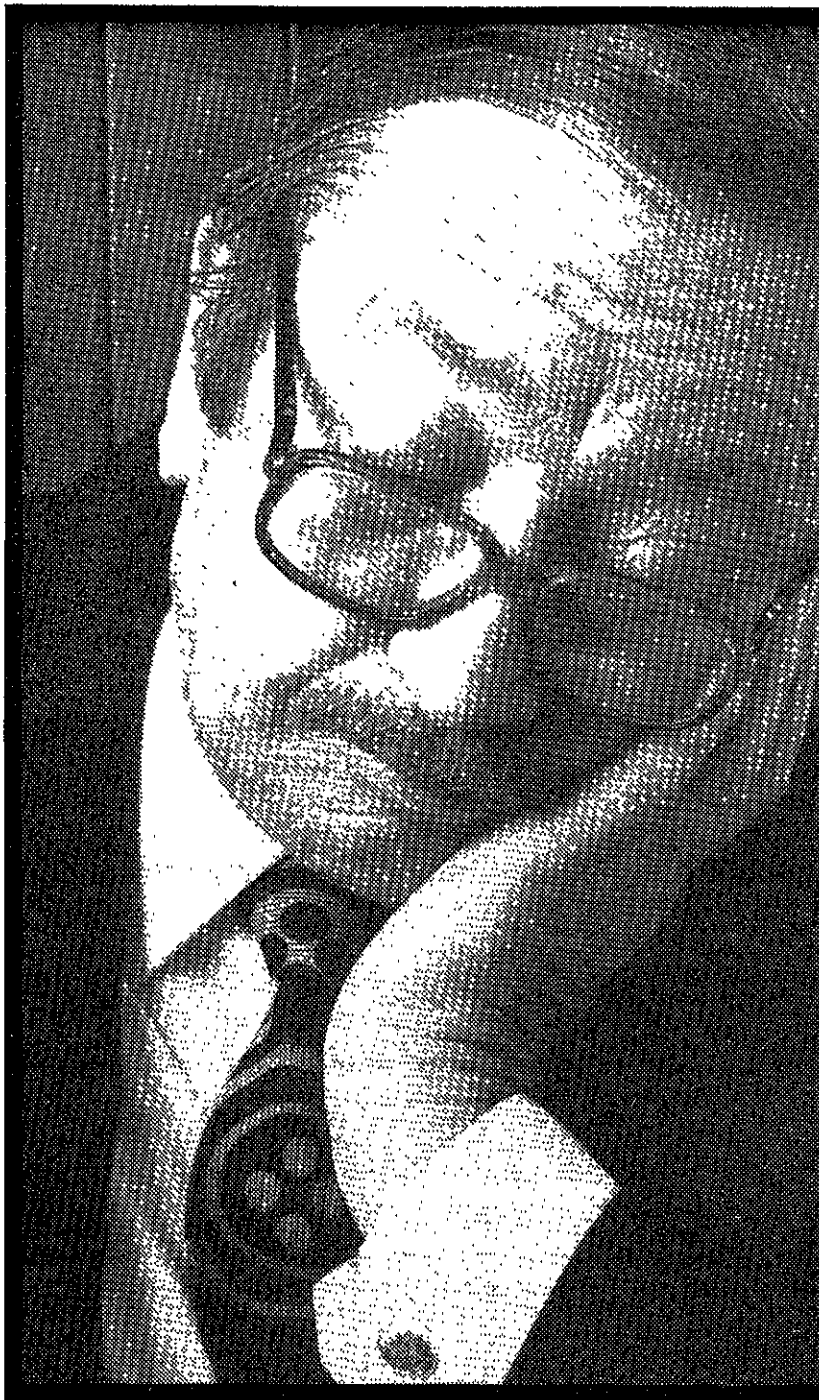

The last thing you need between you and a quick business decision is a slow bank manager.

If you're setting up a business or expanding an existing one in today's climate, you'll find that decisions have to be taken pretty fast.

And the last thing you need is a procrastinating bank manager.

At Nedbank we've been making quick decisions ever since we lent Paul Kruger the money to set up the first explosives plant at Modderfontein. So if you're looking for money and advice in a hurry, set up a meeting with your Nedbank branch manager.

He'll tell you the various methods of raising finance, the best one for you and exactly how much you need.

And he's probably also the man who'll be making the decision.

If you believe that time is money, come on in. You're our kind of customer.



Nedbank Limited Registered Commercial Bank

As a matter of interest: No one can give you better advice on how to run a successful business than your Nedbank Manager. After all, he's part of the team that helped make Nedbank the largest South African owned banking group.

GREY-PHILLIPS, BUNTON, MUNDEL & BLAKE 65602

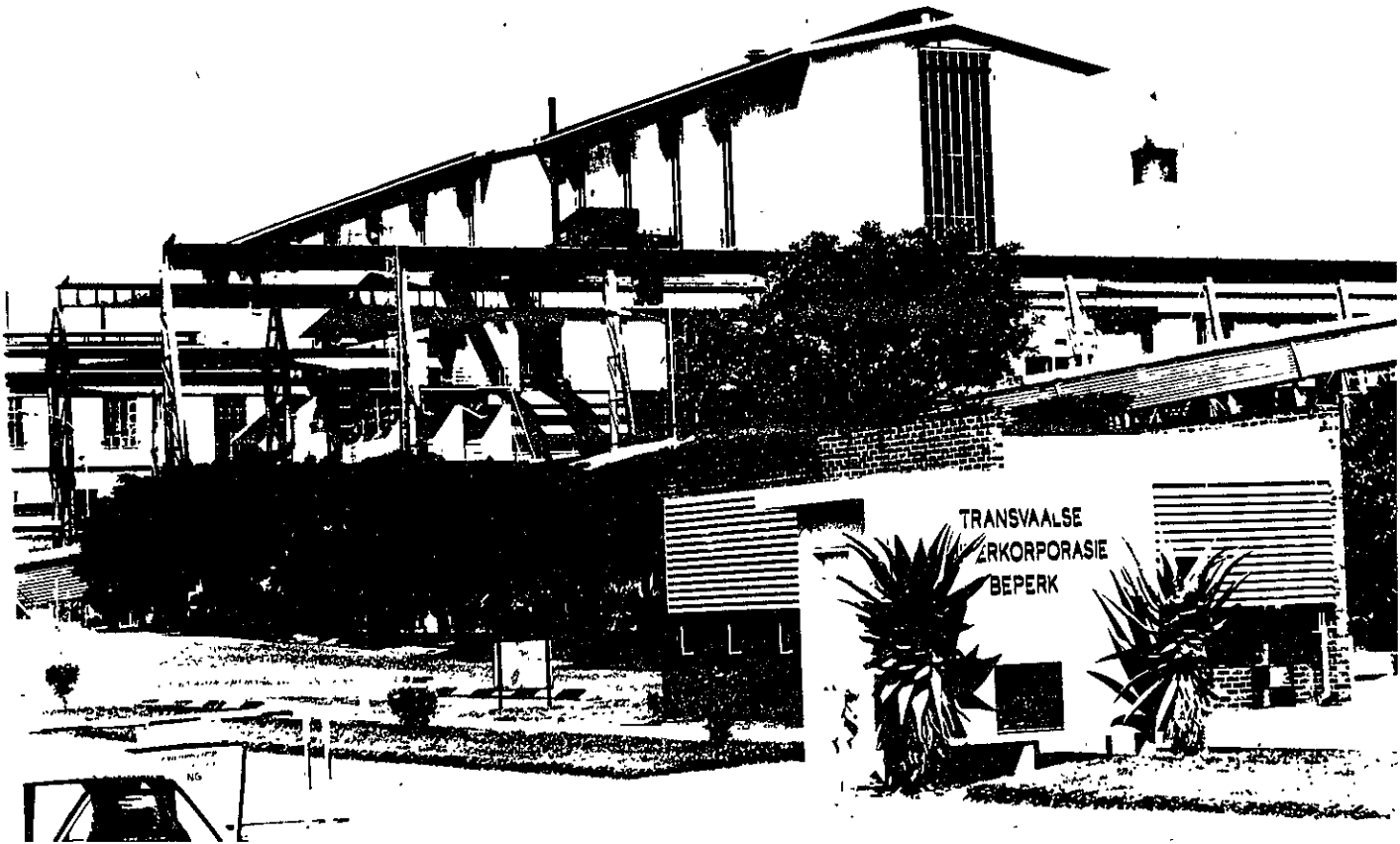

TRANSVAALSE SUIKERKORPORASIE BEPERK

The company, better known as TSB, was founded in 1965 with a share capital of R12,5 million and is presently a full subsidiary of Volkskas Nywerhede Beperk.

The company's main activity is the manufacture of refined sugar at its sugar mill just outside Malelane in the Eastern Transvaal Lowveld.

About 20% of the sugar cane crushed at the mill is supplied by its own estates near Malelane, Komatipoort and Kaalrug. The balance comes from approximately eighty cane growers who are farming along the major rivers in the area stretching between Schagen near Nelspruit to Komatipoort on the Mozambique border.

The establishment of TSB in a relatively untamed part of the Lowveld, where most farmers had to rely on vegetable crops with all its uncertainties, due to marketing and climatic factors, has brought stability, prosperity and employment to many.

During 1967, the first year of production, 720 000 tons of cane were crushed which has steadily increased to a record 1,6 million tons in 1980, resulting in a record profit figure for the season which ended on 31st March 1981.

TSB is situated in one of the few remaining areas where substantial areas of land can still be made available for sugar cane production. This presents us with a number of exciting possibilities, the feasibility of which are continuously being investigated. In response to these challenges, the Board of Directors has recently approved a R18 million programme for improvements to the mill.

The trust that was placed by the founders of TSB in the region, its people and sugar, has yielded handsome rewards. This together with the potential for further development, has made it one of the most exciting areas in the South African Sugar Industry.



J. D. Kritzing



D. Hurter

PRODUCTIVITY RATES

Each of the mills, or groups, have had varied production levels in the last three seasons.

While this was partly due to changes in their technical operations, the main culprit for the drop in output was the severe Natal drought.

The effect on each of the companies

differed, depending on geographical position. But the result has been summed up in one repeated word: "disastrous."

To get a genuine comparison group to group (or mill to mill in the case of Tongaat, TSB, Umfolozi and Union) the first five statistics are relevant.

The indications of the hectareage "area under cane" and "cane harvested" refer to the areas managed, leased or owned by each company. In the case of TSB, "cane area cut" and "tons cane/hectare cut" refers to those two stats for the entire area the Malelane mill handles.

SMITH'S

	1978/79	1979/80	1980/81
Tons sugar	733 483	837 987	649 954
Tons cane	6 668 240	7 369 995	5 585 546
Ratio cane/sugar	9,09	8,79	8,59
Overall recovery %	86,57	87,12	86,22
Sucrose % cane	12,71	13,05	13,47
Area under cane	22 587	21 061	21 213
Cane harvested	1 135 352	1 187 816	859 289

TONGAAT GROUP

	1978/79	1979/80	1980/81
Tons sugar	210 038	217 573	140 604
Tons cane	1 875 351	1 911 460	1 246 006
Ratio cane/sugar	8,93	8,79	8,86
Overall recovery %	87,78	87,02	86,10
Sucrose % cane	12,69	13,00	13,03
Area under cane	14 888	15 257	15 342
Cane harvested	786 493	750 229	518 312

HULETT'S CORPORATION

	1978/79	1979/80	1980/81
Tons sugar	702 000	628 000	448 000
Tons cane	6 332 000	5 564 000	3 962 000
Ratio cane/sugar	9,01	8,85	8,84
Overall recovery %	87,01	87,44	84,66
Sucrose % cane	12,66	12,83	13,25
Area under cane	17 200	17 800	17 800
Cane harvested	910 000	835 000	555 000

UMFOLOSI CO-OP

	1978/79	1979/80	1980/81
Tons sugar	131 984	98 053	111 642
Tons cane	1 255 131	922 804	944 044
Ratio cane/sugar	9,51	9,41	8,46
Overall recovery %	82,35	84,47	85,49
Sucrose % cane	12,71	12,53	13,78
Area under cane	22 050	22 300	22 700
Cane harvested	1 255 131	922 804	944 044

TRANSVAALSE SUIKERKORPORASIE BPK

	1978/79	1979/80	1980/81
Tons sugar	164 925	167 295	170 700
Tons cane	1 486 344	1 503 854	1 574 827
Ratio cane/sugar	9,01	8,99	9,23
Overall recovery %	85,94	86,09	85,44
Sucrose % cane	12,90	12,91	12,68
Cane area cut (hectares) ...	14 892	15 934	16 432
Tons cane/hectare cut	99,8	94,6	95,8

UNION CO-OP

	1978/79	1979/80	1980/81
Tons sugar	51 917	65 166	50 003
Tons cane	515 225	565 375	412 598
Ratio cane/sugar	9,92	8,68	8,25
Overall recovery %	85,04	87,94	86,77
Sucrose % cane	11,80	13,03	13,89
Area under cane	400	475	520
Cane harvested	21 926	21 561	24 806

remainder is under furrow irrigation drawn from the Crocodile, Komati and Lomati rivers.

The system feeds TSB's own estates (around 20% of the cane delivered to the mill) and the private farmers in the area.

Another advantage they enjoy is lower vulnerability to pests and diseases. While Natal crops are being eaten alive, and not so slowly, Eastern Transvaal cane has escaped much of this infestation.

Says TSB MD, Fasié Kritzinger: "We, fortunately, have no eldana, mosaic or other pests and diseases worth mentioning.

"The only exception is smut, which attacks one of our cane varieties. But even this is controllable. The susceptible variety is being replaced by one which is

smut-resistant."

Although TSB have had no large developments of either plant or land utilisation recently, there is an R18m improvement programme coming into focus.

Already approved, is an improved cane intake facility and an additional cane difuser, boiler and power plant.

The mill's throughput, currently with a capacity of 325 t an hour, is due to be pushed up in phases to 450 t an hour in the medium to long-term.

And, says Kritzinger: "This will make it possible to process cane from an additional growing area of about 8 000 ha.

"With an increase in both capacity at the mill and in our cane growing, we should be looking at an annual sugar production of 270 000 t.

"And the climb in our end-production rate of more than 50% will naturally have a beneficial effect on our return on capital."

Apart from the fortunate protection from drought and disease, the Malelane mill has also pushed up its productivity rating in the past five years (see chart).

The company was founded in 1965 as a joint General Mining (40%) and Volkskas (60%) venture. It is now a wholly-owned subsidiary of Volkskas Beperk.

Recently there have been changes to the board and a number of well-known names appeared.

Dr Andre du Toit, chairman of Volkskas, and Dr Pieter Morkel of Volkskas Nywerhede Bpk, have just been appointed to seats on the board. The other familiar personalities are Albert Marais, chairman of Saambou Nasionaal; Dr Tom Muller, chairman of Iscor; Jan Visser, former deputy-secretary of the Department of Industries; Danie van Huyssteen, MD of Volkskas; Dr Jan Hurter; Johan Badenhorst; Goshe Szokolay and Hannes van den Berg.

MALELANE MILL — PRODUCTIVITY INCREASE

	1976/77	1977/78	1978/79	1979/80*	1980/81
Time efficiency	61,49	62,08	72,55	73,97	76,90
Mechanical efficiency	79,09	84,13	85,99	90,44	91,87

* Preliminary figures

LOOKING AT SUGAR

A Committee of Enquiry was announced in Pretoria on March 26 by Dr Dawie de Villiers, Minister of Industries, Commerce and Tourism.

The committee will be chaired by Dr Athol Rorich.

There are probably two main aspects for the Committee to investigate. The primary is likely to be the extent and areas in which the industry could viably expand. The controversial one would be price control. Should it re-

main, or should the industry be allowed to operate on a free market basis in the local market?

Rorich is well known to the sugar industry after his work for the Commission of Enquiry in the late Sixties, and for various Board of Trade investigations.

One of the results of the investigations was the 1976 report on the level of returns in the industry. This report suggested the returns should be set at a

higher level. But the recommendation was not accepted by the government.

Sugar industry officials are hopeful that a later investigation will be made.

The industry is now heavily in the red after a poor season.

The deficit reached R90m last year, of which R80m was borrowed from financial sources. The R10m difference is being absorbed as a reduction in the returns on capital of the growers and millers.

Exports down

The effect of the drought has reduced exports by 43,5% and lost the industry a conservative R250m

Despite the drop in the International Sugar Agreement quota at the beginning of 1980 and the world price reaching its highest level in five years, tonnages for export were low because of the severe drought.

The average tonnage the industry can produce is now estimated at around 2,2 Mt/year, but the 1980-81 season produced only 1,61 Mt.

The industry is committed to supplying local demand first. This absorbed more than a million tons. That left an export quota almost half the size of the 1979/80 offtake of 105 Mt (after allowing for stock adjustments).

Fortunately, the Sugar Association was able to meet its contractual obligations from the 595 279 t sent abroad during the season.

The minimum Japanese requirement of 350 000 t was met with a disposition of 367 722 t. While this exceeded the minimum, it was down on the 1979-80 total by

90 404 t.

The Canadian contract minimum had been set at 215 000 t, but this was reduced to around 180 000 t, mainly at Canada's request. Eventually, the total Canadian offtake was 179 747 t, a drop on the demand in the previous season of 9 513 t.

Most noticeable was the amount available for export to the US. In 1979/80, America took 122 488 t, but this fell last season by 74 928 t to only 47 560 t.

The tonnages exported include 5 340 t of high test molasses (HTM), added to the raw sugar at the time of loading for shipment.

The HTM is used to adjust the polarisation percentage of SA raw sugar to a level where it can avoid duty in the countries of import and to suit the requirements of the overseas refineries. The high quality of

the local product is reflected in its polarisation at the time of production of about 99,4°.

Duty in Japan, for example, is levied on sugar of more than 98° and HTM has to be added to the Japanese exports to keep the percentage down to 97,9°.

The North Americans allow for a higher polarisation and many of the Canadian refiners import their sugar at 98,7°. In fact, certain refineries are incapable of processing low quality raw sugar.

Polarisation is done at the Durban harbour sugar terminals as each ship is loaded. And the HTM (which is a SA patented process) is added to suit the needs of that shipment's end-user.

Although SA raw sugar now has an exceptional reputation for its high quality, this has not always been the case. In the mid-Sixties, the sugar exported was of a very much lower quality, which meant it was considerably less acceptable to potential customers. But a programme was devised to develop new milling processes, which brought the polarisation up to a very competitive level.

SUMMARY OF DISPOSITIONS

	(Metric tons)		
	1978/79	1979/80	1980/81
Japan	462 848	458 126	367 722
Canada	251 218	189 260	179 747
South Korea ..	24 417	—	—
USA	36 791	122 488	47 560
Animal feed ..	—	142 746	—
HTM (sugar equivalent) ...	48 913	138 473	36
Refined exports (raw equiv) .	136	309	214
Mill loss	—	450	—
DISPOSITION	824 323	1 051 852	593 279

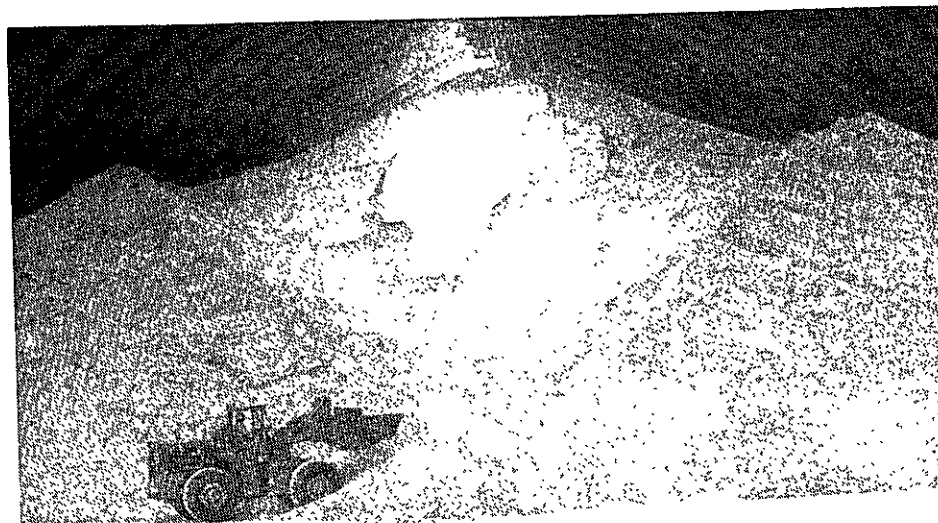

Sugar, and more sugar, for the world

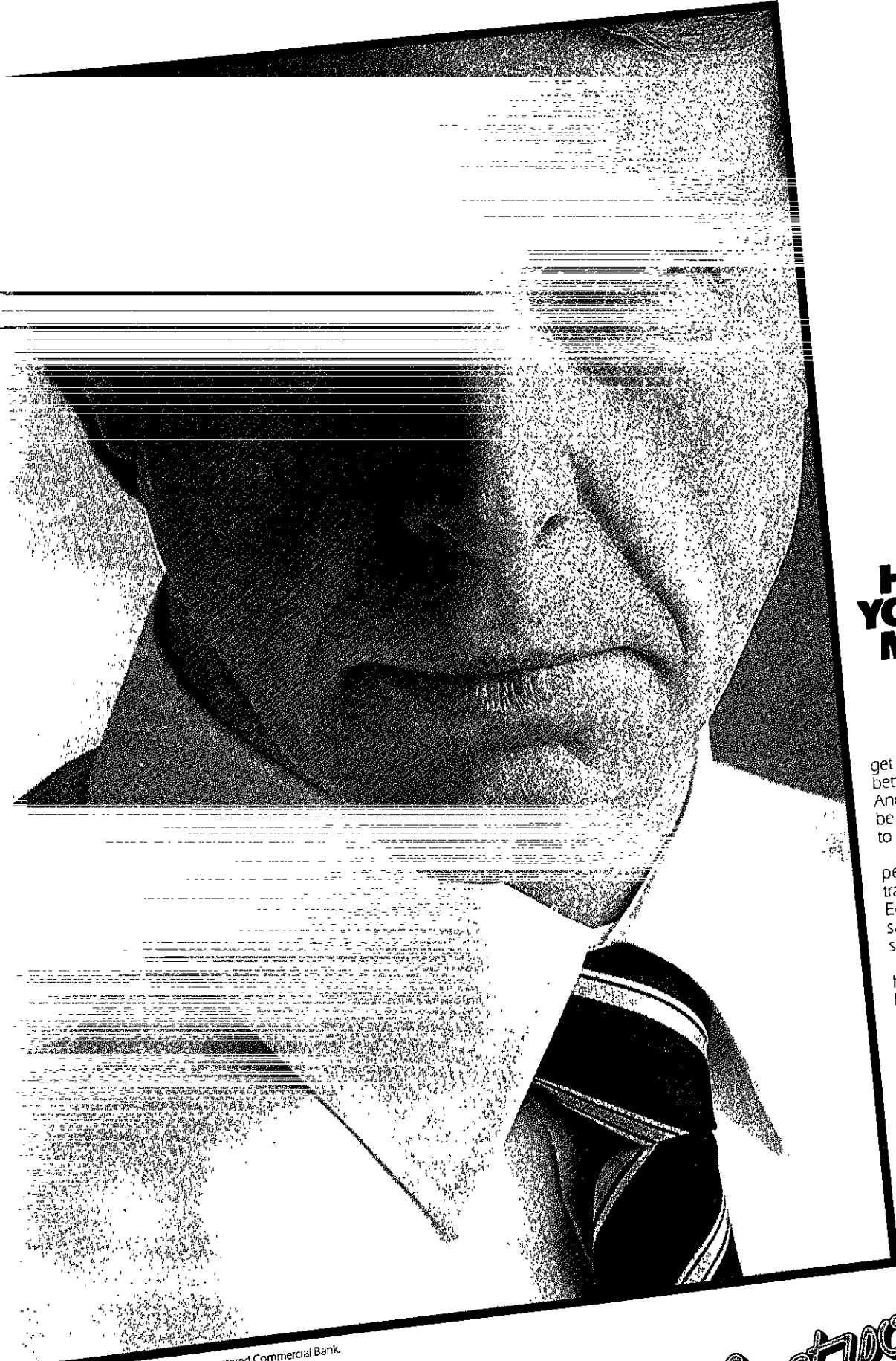

HOW CAN YOUR BANK MANAGER GET YOU GOING?

At Barclays we believe that to get your business we have to be better bankers than anyone else. And to be better our people have to be better. So we have done our best to ensure this.

Firstly, we are training Barclays people above and beyond traditional banking standards. Equipping them to put more into satisfying your financial needs with speed and efficiency.

Secondly, Barclays people are highly motivated. Because at Barclays we have special programmes that reward the efforts and dedication of each individual.

So it is worth their while to make sure you are a satisfied customer. This applies to everyone from the doorman to myself.

So whatever your financial needs, at Barclays we will knock ourselves out to get you going.

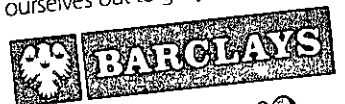

We'll get you going

Barclays National Bank Limited • Registered Commercial Bank

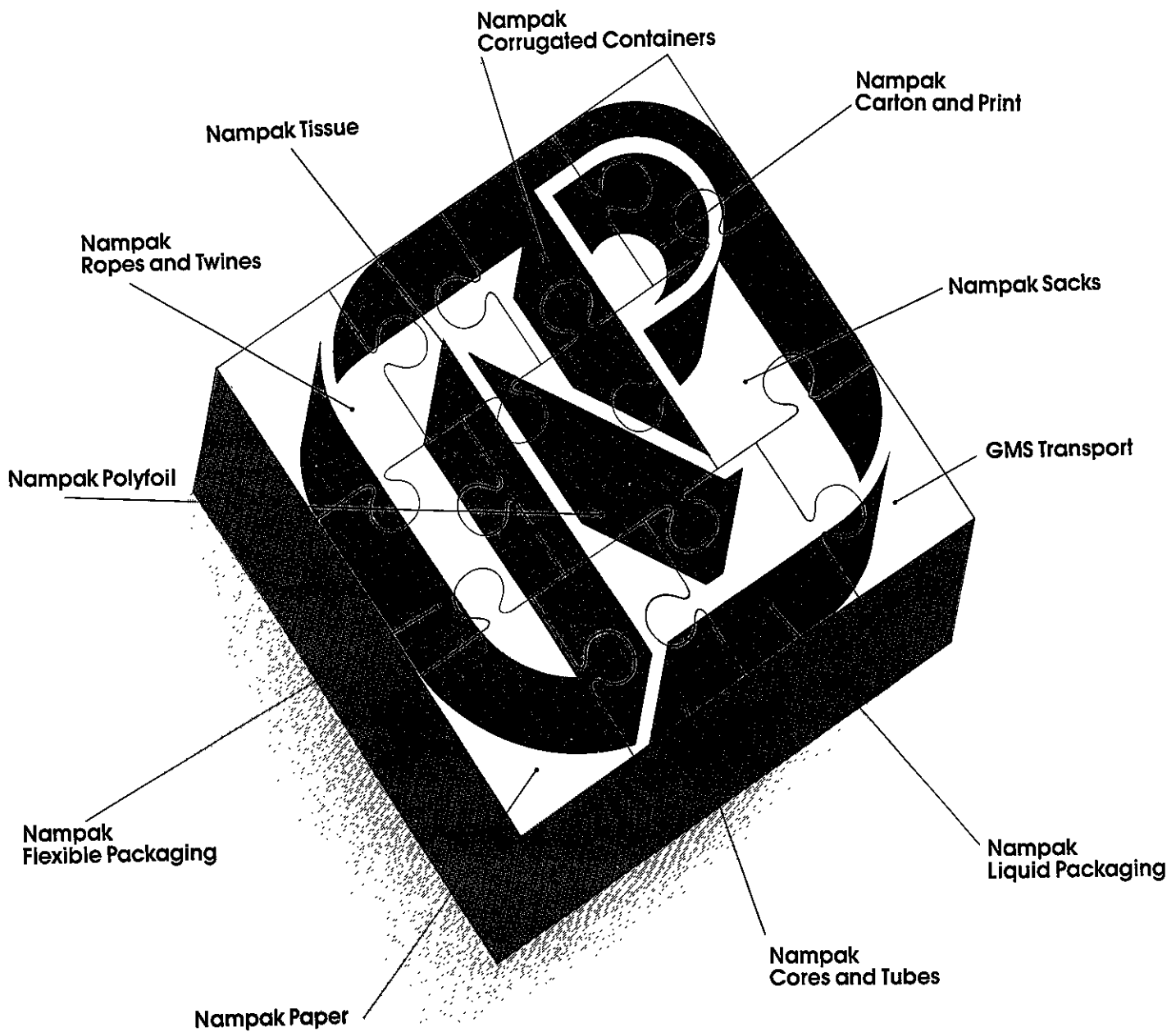

Now, Nampak can give you an even greater package deal

As the largest packaging group on the African continent, Nampak is committed to the most effective marketing of its products.

As a result of this commitment, Nampak Ltd has restructured and streamlined its organisation to meet both the

needs of its customers and the growing requirements of South African and international markets.

With effect from 1 October 1980, one large operational company, Nampak Products Limited, will represent the manufacturing and trading arms of the Group's well-

known subsidiary companies. Nampak Products Limited will operate through eleven product divisions as shown above.

Nampak is represented throughout South Africa and neighbouring territories.

Nampak Limited Head Office
5 Girton Road, Parktown.
P.O. Box 189, Johannesburg.
Tel: 643-6928.



Nampak
for a great deal in packaging

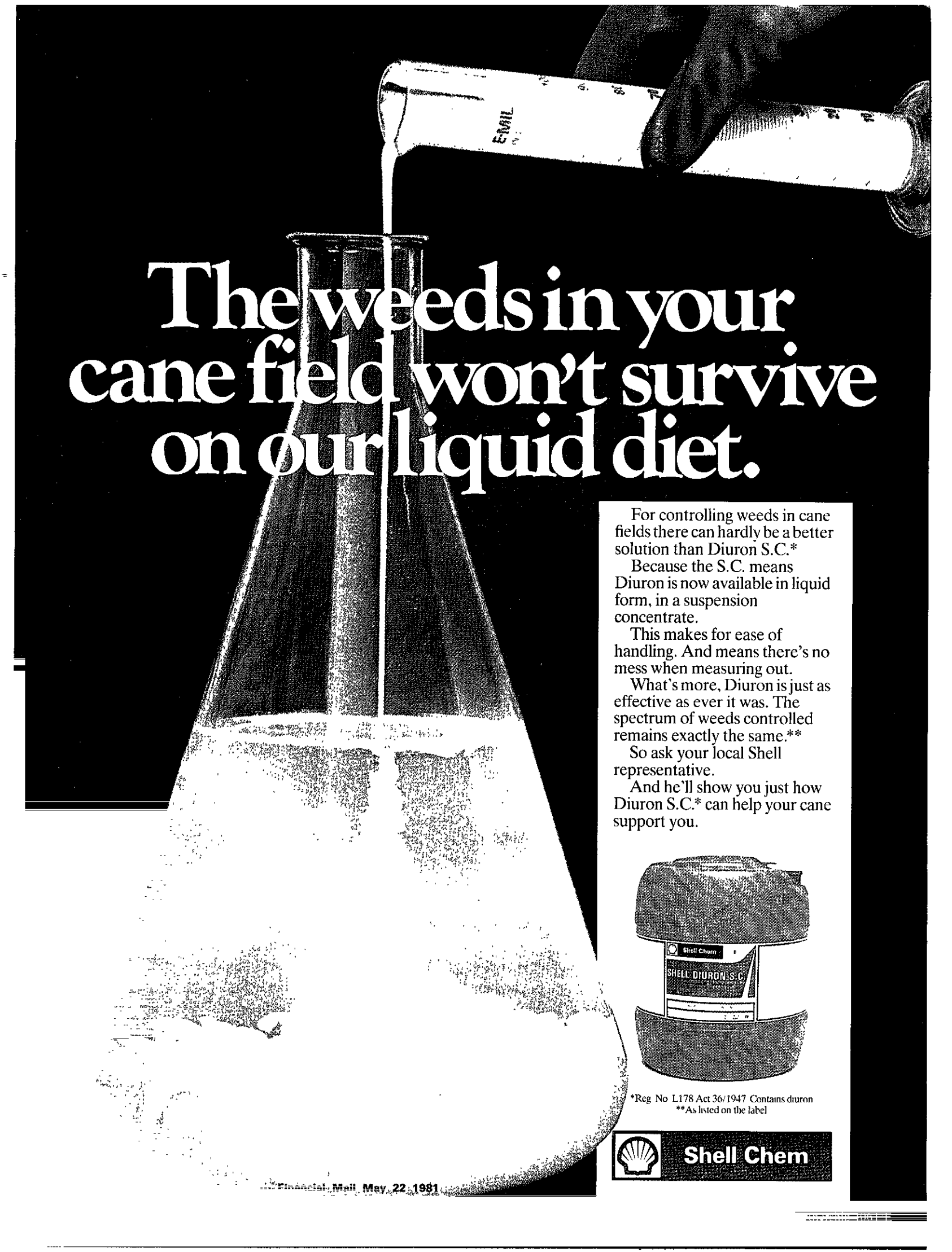

The weeds in your cane field won't survive on our liquid diet.

For controlling weeds in cane fields there can hardly be a better solution than Diuron S.C.*

Because the S.C. means Diuron is now available in liquid form, in a suspension concentrate.

This makes for ease of handling. And means there's no mess when measuring out.

What's more, Diuron is just as effective as ever it was. The spectrum of weeds controlled remains exactly the same.**

So ask your local Shell representative.

And he'll show you just how Diuron S.C.* can help your cane support you.



*Reg No L178 Act 36/1947 Contains diuron
**As listed on the label



Shell Chem

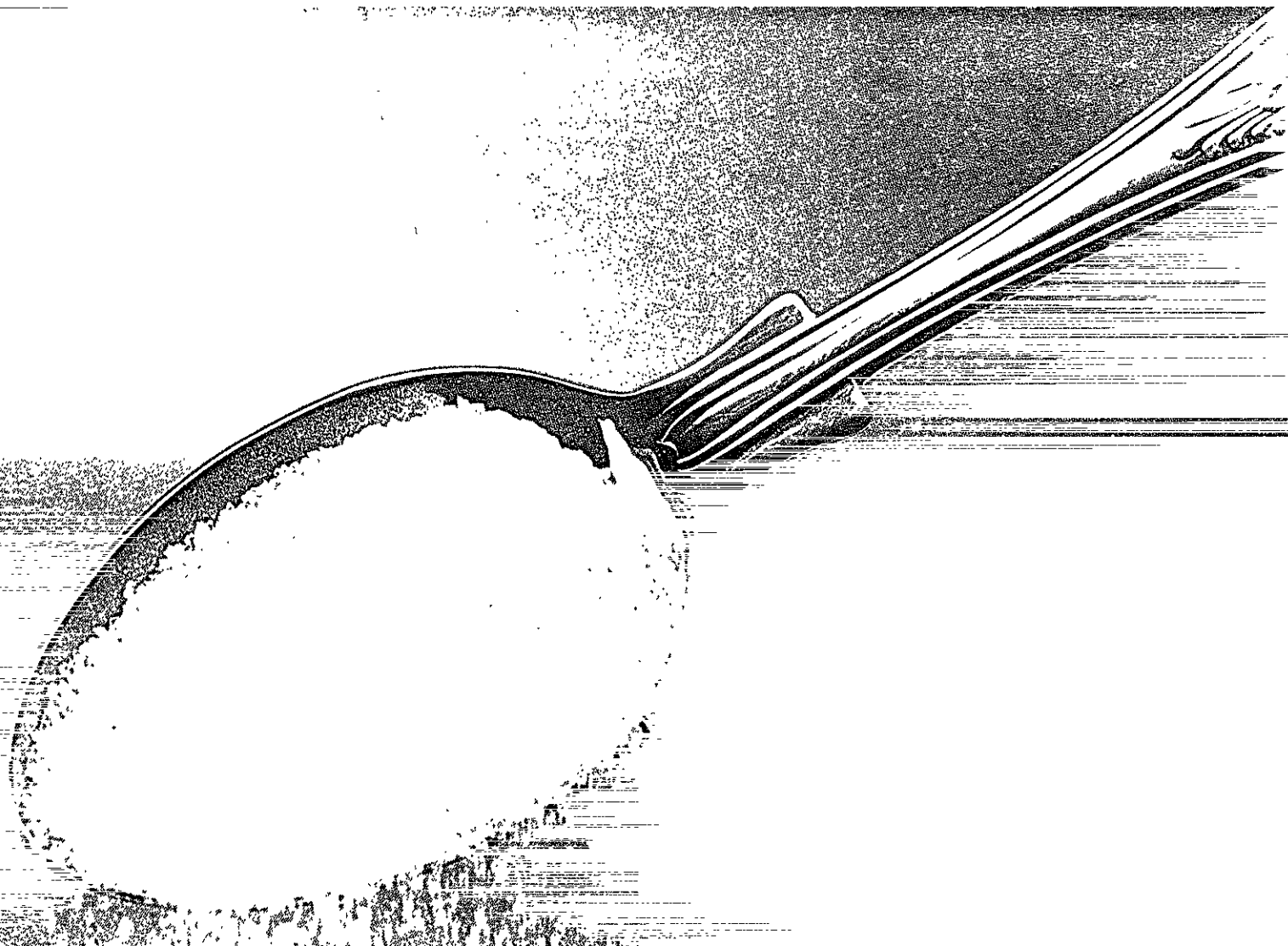

THE SWEDISH NAME IN SUGAR

C&F Smith Sugar has grown from strength to strength and today it has the capacity to produce over 800,000 tons of sugar — more than enough to maintain our position as South America's largest sugar producer. The company is also a major exporter of sugar to world markets.

C&F SMITH
SUGAR LTD.



The sugar world

The SA sugar industry sits in the world top-dozen on its annual production tonnage

Rated against the other 122 sugar producing countries in the world, SA is the twelfth largest producer with a 2.3% share of the total average tonnage in the last three years.

This figure, and the others in the chart, are calculated from the second estimate of 1980-1981 world production of F O Licht's International Sugar Report of January 28 1981.

They cannot be regarded as accurate to the ton, but there is significant enough leeway between the various countries' production rates to accept them for place charting. The choice of a May-April crop year also distorts the figures with the north/south seasonal difference. But the estimates are looked on by sugar industry analysts as accurate enough for marketing purposes.

About 74% of world sugar production is consumed in the country of production. About 6% is traded under special arrangements, such as the one between Cuba and Russia, and the Lomé Convention regulating EEC imports from African, Caribbean and Pacific countries.

So the free market is a residual one of some 20% of the world total.

Very volatile price movements in this sector can, and do, occur. Any surplus or deficit in world production is considerably magnified in the free market.

This variation is seen in figures from 1967. The free market world price hit a low of £12.5/t in that year. November 1974 saw the price reach £650/t, which fell to £81/t in 1978. It rose again to £410/t in November 1980, since when it has dropped off to the present level of around £190-£210.

The only controlling mechanism on this effervescent fluctuation is the International Sugar Agreement (ISA). The most recent control came into force on January 1 1978.

"This, like its predecessors with economic provisions," says SA Sugar Association GM Peter Sale, "can be viewed as a device to regulate the market. It reduces the inherent risks for producers and consumers arising from the residual nature of the world free market."

The method of regulation was basically an endeavour to keep the world price within a range by controlling the supply on the basis of quotas for individual exporters.

There is also a provision which requires exporters to accumulate quantities of uncommitted stocks when the price is in the lower part of the range, and to allow these



Chopping sugar for the world market

stocks to be released when the price reaches the top part. This provides additional supplies for the world market.

The range was originally fixed at 11-21 US cents/lb — at current exchange rates — an equivalent of £120-£210/t. But the high level of inflation in recent years, and the depreciation of the US dollar, has pushed this range up twice to the present level of 13-23 US cents/lb (£135-£230/t).

Prices during the first two years of the agreement remained below the minimum

level of the ISA range. The main reason was excess supply. However, in the latter part of 1979, the price, along with that of many other commodities, began to rise.

The prices of precious metals, especially gold, had surged upwards and sugar was caught in this boom atmosphere in the commodity market.

A large speculative element (as opposed to parties genuinely interested in physical sugar) entered the market believing sugar was undervalued. And their interest

BARLOW RAND LIMITED

FINANCIAL STABILITY IS JUST ONE SIDE OF THE COIN

Since its founding in Durban in 1902, one of Barlow's main strengths has been its people.

Clear thinking, dedicated South African men and women who, with sound judgement and great integrity, have helped to make Barlow Rand South Africa's foremost industrial group.

In mining, manufacturing, commerce, property and agriculture, the people of Barlow Rand have paved the way for continued growth and prosperity and a better way of life for all South Africans.

Yes, financial stability is of vital importance, but it is only made possible by the other side of the coin - the 193 000 men and women that are Barlow Rand.



SUGARCANE PRODUCERS

Country	Annual average tonnage for 3 years	% world cane production over 3 years	% world sugar total over 3 years
	x1 000 tons raw value		
Brazil	7 711	14.5%	8.8%
Cuba	6 945	13.06%	7.95%
India	5 400	10.15%	6.18%
Australia	3 140	5.9%	3.59%
Mexico	2 884	5.4%	3.3%
Philippines	2 405	4.5%	2.7%
China	2 221	4.17%	2.36%
South Africa	2 069	3.89%	2.36%

BEET SUGAR PRODUCERS

Country	Annual average tonnage for 3 years	% world beet production over 3 years	% world sugar total over 3 years
	x1 000 tons raw value		
USSR	8 033	23.5%	9.19%
France	4 213	12.3%	4.8%
West Germany	3 018	8.8%	3.4%
USA	2 772	8.1%	3.17%

helped materially to push the prices higher, despite the regulatory mechanisms which were adopted under the ISA.

Apart from the first two months of 1980, the world price remained above the ISA

range throughout the year. And the ISA has literally moved into a free market supply-demand situation, and lost its "control."

The release in the early part of 1980 of

all the two years accumulated stocks, increased the supply available to the market, but it did not stem the upward rise of the price.

The reason: world consumption had exceeded world production and this depleted reserves.

Slowly, the speculator influence fell and sugar fundamentals became the major consideration.

A poor beet crop in Russia, and the inadequacy of the Cuban crop, were major reasons for the undersupply.

But several other countries, including drought stricken SA, added to the problem with low production.

Brazil's predominance on ethanol production, rather than sucrose, added to the shortfall.

The net result was disorientation in supply/demand, and the world price rose. Will it increase further?

David Hardy, export manager of the Sugar Association, won't be drawn. Despite Cuban "rust" problems, Russian shortfalls and drought in SA, he and GM Peter Sale are being conservative. They are looking at a 1981 price, given the current fluctuation, of between £250/t and £300/t.

Company Secretary

● SWAZILAND. SUGAR. ● FIVE YEAR CONTRACT WITH OUTSTANDING REMUNERATION PACKAGE INCLUDING GRATUITY AND SUBSEQUENT CONTRACTS WITH ADDED INCENTIVES

One of the top sugar estates in Southern Africa requires a versatile and enthusiastic Company Secretary to join the top management team.

Applicants should be qualified CIS or B.Comm with good practical experience in the accounting, secretarial and administrative fields. An agricultural background would be an advantage but is not essential.

The Company Secretary will report directly to the Managing Director and will be responsible for the financial, accounting, secretarial and administrative functions of the company.

The management team is small but effective through commitment

and enthusiasm which gives real scope to be creative and gain experience in a dynamic management situation. It means too that the successful applicant will on the one hand have to manage situations outside of his own discipline and on the other be prepared to clear more mundane work himself.

Maturity is required for the responsibility carried and the exercise of tact as well as the handling of confidential information. Thus candidates should be over 30 years of age.

WHEN PHONING MR BRIGGS (BETWEEN 08h00 AND 10h00 ONLY) PLEASE QUOTE REF. NO. 5331.

This position must be filled as soon as possible. Interested candidates should make application without delay.



All replies treated in strictest confidence. Interviews can be arranged in most areas of the Republic.

The P-E Consulting Group

APPOINTMENTS DIVISION, 7th Floor, ANNUITY HOUSE, Cnr, RISSIK/MARSHALL STREETS, P.O. BOX 8550, JOHANNESBURG, 2000. TELEPHONE (011) 838-6881.

MANAGEMENT, FINANCE, PRODUCTION, MARKETING, PERSONNEL, TRAINING, PROJECT & COMPUTER CONSULTANTS



presenting four obvious yet brilliant features why cargo carriers are the big wheels in industry....

SERVICE — Our reputation for service has yet to be improved upon.

EXPERTISE — Experience gained over the years ensures that we are best equipped to offer a complete range of Road Haulage requirements.

NATIONAL COVERAGE — Our 23 branches throughout South Africa enables us to offer our services on a national basis.

RELIABILITY — The largest privately owned fleet in South Africa, consisting of the most modern heavy vehicles, custom built to guarantee that your particular need is catered for.

TRANSPORT CONTRACTORS TO THE LEADERS IN:

Cement *
Petroleum Products

Coal *

Sugar *

Ferro Manganese *
Molasses *

Foodstuffs *
Steel Products *

Liquid Chemicals *
Mining Haulage *

TOGETHER WITH THE HANDLING OF ALL OTHER BULK PRODUCTS

CargoCarriers

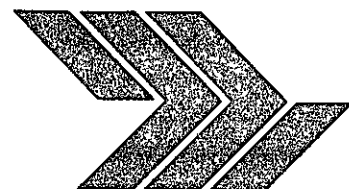

BRANCHES THROUGHOUT
SOUTH AFRICA &
SWAZILAND

TEL 36-6311
P O BOX 201,
ISANDO, TRANSVAAL
1600
TELEX 8-2997

Terminal to the world

The Durban Sugar Terminals speed up sugar loading from 1 000 t a day, using the old manual method, to 750 t an hour

The three bulk sugar silos in Durban built at a cost of R18m, have revolutionised the handling of SA export sugar since 1965.

Like other bulk-handling installations in the port, the Terminal has eased the strain on the berths in the harbour.

In pre-terminal days, using an 18 000 t ship, it would have taken 55 ships 990 days to load 1 Mt of sugar at one berth. It is now possible to load the same number of ships in only 55 days.

That frees the one sugar berth for the remaining 310 days of the year for other vessels.

And with an export availability of around the 1 Mt mark (except in years of drought or quota restriction), this is an essential installation.

The original idea was mooted in 1960, when the Bulk Sugar Advisory Committee was faced with a ten-point objective.

REDUCE:

- handling costs of export sugar
- sugar losses

RELIEVE:

- congestion of ships in the harbour
- railway truck shortages
- manpower shortages

ACHIEVE:

- sugar at short notice for export
- uniformity in quality
- space to handle more than one type of sugar
- improvement in quality

PREVENT:

- deterioration of sugar in storage

The result was the construction of the first sugar terminal of 180 000 t capacity in 1965. The other two followed in 1968 and 1972, with an eventual storage capacity of 520 000 t in total.

There remained one problem to overcome. The quality of export sugar was not significantly improved. The trouble here was that refineries in some countries, with government protection laws, had to import sugar at a lower polarity than the 99.4° of the local product. Japan, for example, needs an import polarity below 98°, and the USA, UK and Canada below 99°.

As polarity can be reduced by coating with molasses, the mills originally had to supply sugar coated with final molasses.

This was a slow (no more than 27 t an hour) manually controlled process. And the polarity of sugar supplied by different

mills showed a wide disparity. But, while the high "pol" local sugar can be stored for lengthy periods without any quality drop-off, molasses-coated sugar deteriorates comparatively quickly.

After a detailed examination, it was decided to erect a plant which would coat the sugar crystals with selected molasses immediately before shipment.

This would prevent deterioration of the molasses film, ensure uniform quality and allow the silos to store only one type of sugar.

But the handling of molasses presented a major problem. The substance is so viscous it does not follow fundamental laws (Poiseuille's law) governing the flow of materials, and it also has poor thermo-conductivity.

Intensive research into basic sugar technology and months of calculation eventually came up with the answer. An ingenious heating system was devised to reduce the viscosity 30 times.

Moisture content of the export product was also a difficult problem. If the "safety factor", as it's known in the sugar industry, was incorrect, then unexpected hot or cold conditions could cause the sugar cargo to cake or deteriorate.

This was also remedied by pre-shipment coating.

The problems of storage, variations in polarity, darkening characteristics and moisture content, were therefore all cured. The R720 000 molasses mixing plant was commissioned in 1970, and its accuracy in coating sugars to a polarity of 97° or 98° has run at 0.05% error.

The formula used in the computer controlled process (patented world-wide) was:

TIME, AND SUGAR, SAVING

	Pre-terminal	Terminal	Difference
Labour used to load one ship (10 000 t)...	80 units	33 units	47 units
Man-hours per ship	19 200	792	18 408
Man-days per ship	800	33	767
Man-hours to export crop	10 118 400	310 464	9 807 936
Man-days to export crop	421 800	12 936	408 864
Number of ships required to move crop	527	392	135
Time taken to load one vessel	10 days	1 day	9 days
Total loading time taken	5 270 days	392 days	4 878 days

	1974/75	1975/66	1976/77	1977/78	1978/79	1979/80	1980/81
Total intake	767 164	752 376	905 386	1 025 927	982 051	868 448	534 910
Shipped (bulk)	737 767	725 345	891 632	1 081 522	775 360	898 549	598 698
Number of ships (bulk)	42	39	51	63	45	54	34
Largest cargo shipped.....	32 049	32 024	28 655	40 946	25 904	30 030	31 576
Handling costs	R1 463 862	R1 508 702	R1 711 183	R1 905 662	R1 837 760	R2 194 364	† R2 200 000
Handling costs per metric ton (bulk)	R1.92	R2.10	R1.89	R1.86	R1.87	R2.53	
Rail intake	450 624	458 703	582 092	548 137	431 126	542 165	354 478
Road intake	313 540	293 673	323 284	477 790	550 925	326 283	180 432
Rail intake: Average number of trucks per day .	48	48	46	44	45	48	43
Road intake: Average number of vehicles per day	62	58	54	80	94	60	40
HTM intake	11 500	13 089	10 000	15 396	12 868	14 071	5 340

† Approximation



BELL

Bell Equipment - Built To Perform ASK THE PEOPLE WHO USE IT

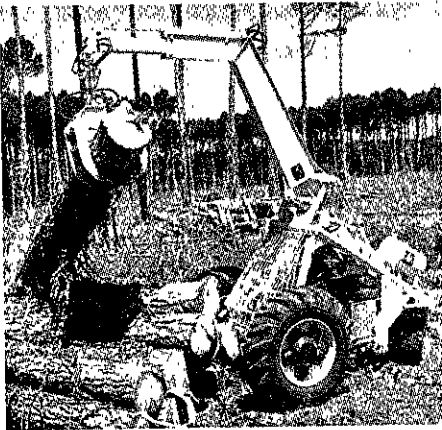

Bell — the name trusted by organisations such as the South African Railways, South African Pulp and Paper Industries, the Sugar Industry and in Mining and Construction.

Designed, manufactured and exhaustively tested in South Africa by South Africans, Bell Equipment meets the high standards of reliability, durability and performance demanded by the toughest industries and conditions.

Our experienced back-up personnel ensures a fast and effective after sales service — a prerequisite of heavy equipment operators.

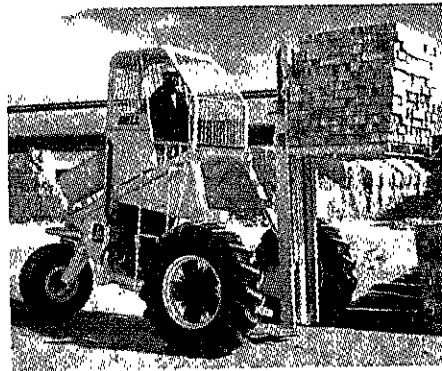

The Bell organisation — on the South African scene for over twenty years — has gained international recognition

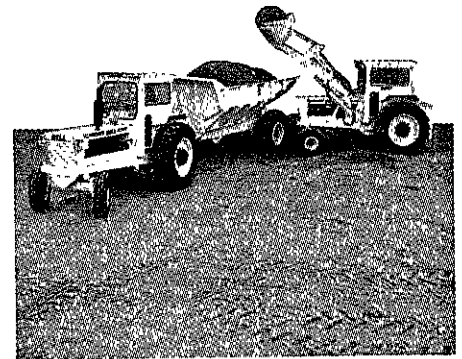

with manufacturing plants, distribution agents and sales offices in the United States of America and several countries around the world.

Bell — thoroughbred South African equipment — making a mark locally and internationally.

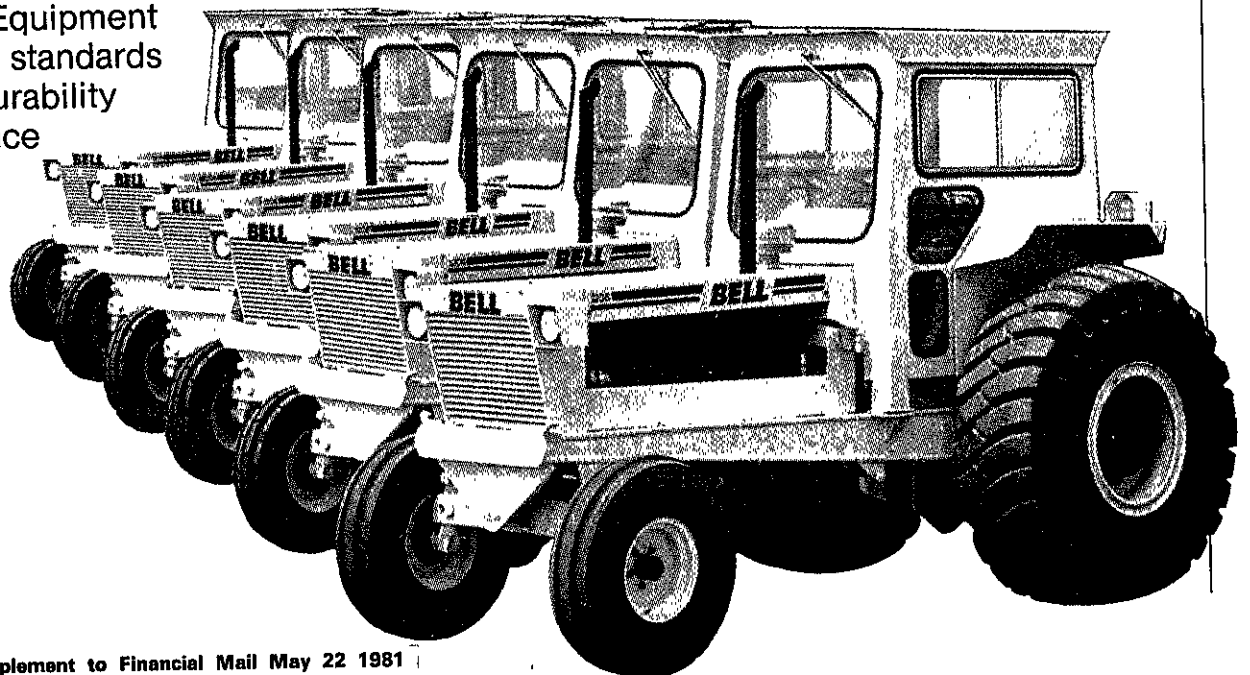



Serving The Sugar Industry

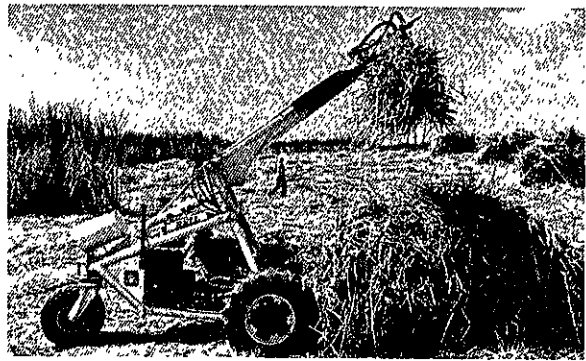

Bell offers a complete range of in-field sugar cane loading and transport equipment. Although an integrated system, the different units are versatile enough to be utilised independently in existing operations. Tested and proven over sixteen years these machines boost productivity.

The Bell Cane Loader can be readily adapted to meet any in-field cane loading and stacking requirements. Using the "interrupted windrow" method results in far cleaner cane as compared with conventional push-piler loaders. This machine's high degree of manoeuvrability and mobility coupled with its compact design and low centre of gravity enables it to operate safely and efficiently on steep slopes and in tight corners.

The simple modular hydrostatic drive system results in minimal maintenance requirements as compared with conventional drives which require steering mechanism, clutch, gearbox, differential, final reduction gearing, brakes and accelerator. The most versatile and cost effective machine on the market.

The Bell Cane Haulers are specifically designed for the purpose of heavy duty haulage. Although of rugged construction, safety and driver comfort have not been sacrificed in the Haulers which have as standard features automatic transmission, power steering, and fail-safe air brakes. The

weight transfer system, incorporated into the design of the machine, ensures improved traction. Driving the Bell hauler couldn't be easier — it's a job for a semi-skilled operator. Maintenance is simplified as a result of the modular design and standardisation of parts used throughout our range of equipment. Service exchange components are always available at short notice resulting in reduced downtime and lower operating costs.

To provide you with a complete and comprehensive service, our backup team is always on hand to discuss your specialised requirements.

Telephone 0351-26915



BELL EQUIPMENT-BUILT TO PERFORM

$W_M = W_s \left(\frac{P_s - P_E}{P_E - P_M} \right)$
 Where W_m = weight of molasses required

W_s = weight of sugar flowing (from belt weighers)
 P_s = "pol" of sugar ex silo (by analysis)

P_e = required pol of export sugar
 P_m = "pol" of molasses from the storage tank (by analysis)

SHIPPING SUGAR

The days when SA was setting world records of bulk-shipping more than 40 000 t of sugar in a single vessel are long gone

There has been a very firm trend recently to ship bulk raw sugar in smaller vessels.

The foreign refineries are now facing high interest rates on borrowed money. This has led them to try to replenish their stockpiles more frequently and cut down on their stock inventories and interest payments.

According to SA Sugar Association export manager David Hardy, the average tonnage shipped in bulk carriers is now about 16 000 t, although the Safmarine contract is still fulfilled by vessels of more than 22 000 t.

"But," he says, "the export programme of five years ago, when raw

sugar was shipped in vessels of more using contracted ships from two lines, with the remainder of exports going out from the Durban Sugar Terminal on open market charter.

The Canadian exports are handled entirely by Montreal-based Federal Commerce and Navigation. The contract with Federal, drawn up in 1969, is not due for renewal until 1985.

This contract was originally arranged because of the lack of suitable ships sailing between Durban and the Canadian east coast.

Japanese demand is satisfied by a combination of SASA/Safmarine contracted vessels, and vessels fixed on

open market charter.

The contract with Safmarine is currently under review, as the present one terminates on June 30.

The US shipments are all open market charter.

Because of the infrastructure of the sugar terminal only bulk carriers are used to transport SA's raw sugar exports. And, says Hardy, the demand for raw sugar takes up most of the available export tonnage. This has meant that in the last five or six years very little refined sugar (packed in 100 kg or 50 kg bags) has been exported.

"The other problem," he adds, "is the difficulty of exporting refined sugar on an economic basis in a fiercely competitive world market.

"The European Economic Community (EEC), which is the largest producer of refined sugar, has a subsidy scheme under the EEC Common Agricultural Fund, and this underprices virtually all competitors."

On the local scene, all of the coastal shipments for domestic demand are handled by the Durban-based Unicorn Lines, whose contract with SA Sugar Distributors runs till 1985.

Unicorn ships about 350 000 t a year to East London, Port Elizabeth, Mossel Bay, Cape Town, Port Nolloth and Walvis Bay. This tonnage is variable, and the barometer of it is the fruit canning industry, which is the major end-user. In years of poor fruit crops, or a diminished world market, there can be a significant drop.

Unicorn has recently been conducting trials to improve the speed of handling and reduce damage to the shrink-wrapped loads of bagged sugar.

The Cape Town cargoes are now mainly sent by container, while the PE and East London cargoes are still break-bulk. And the break-bulk handling is going through the trials which may offer a viable alternative to containerisation. Using cardboard slip-sheets instead of the conventional wooden pallets, and a special Cascade-designed push-pull attachment on a conventional forklift, Unicorn has managed, in trials, to improve its discharge timing by approximately 20%.

The overall effect of the alternative method has been an increase in offloading to about 50 t an hour — a great improvement on the system using individual bags packed in-hold.

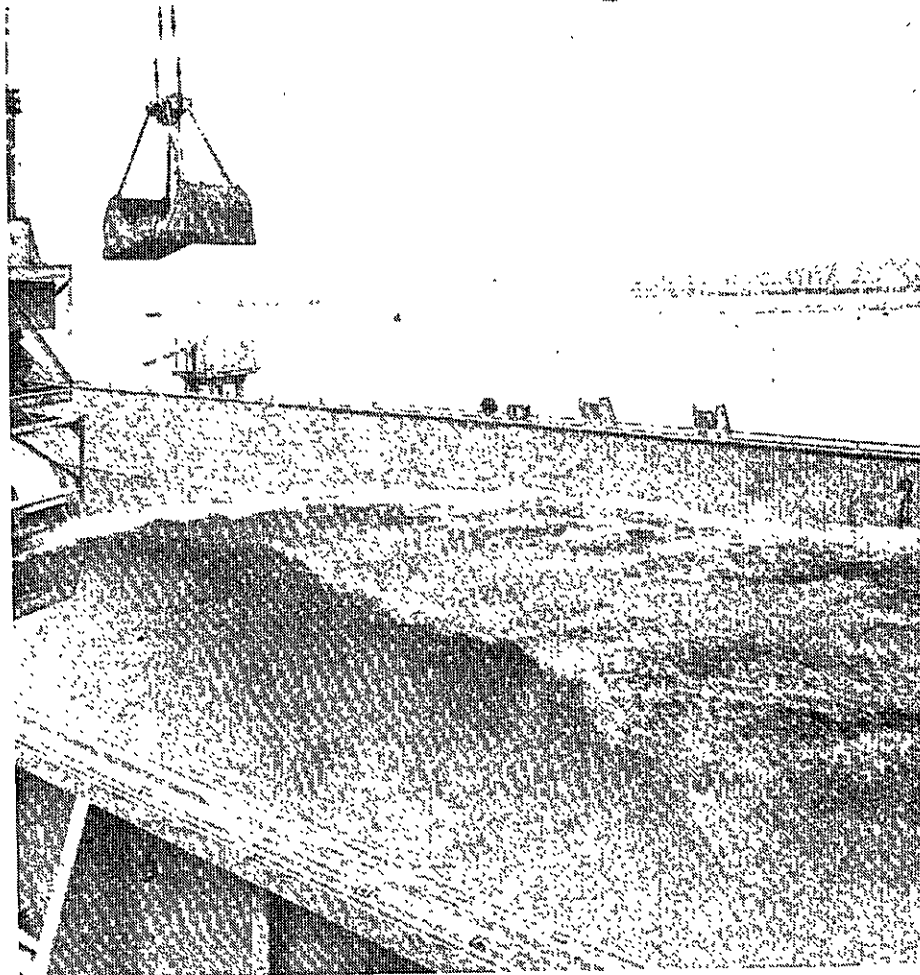

A wild flow of sugar for the seas

It's an engine oil, hydraulic fluid, transmission
and wet brake lubricant all in one —

Caltex Super Tractor Oil.

The Big One

Saves you expensive
misapplication costs.
Saves you storage space.
Saves you time.
Saves you money on
duplication.

Meets manufacturers'
performance require-
ments.

• Ford • Massey Ferguson
• John Deere
• International Harvester
• Allison • Fiat Vetsak
• Caterpillar • Landini.

It works in
your tractor's engine,
transmission, gearbox,
wet brakes, final drive,
power steering,
hydrostatic drive and
power take-off.

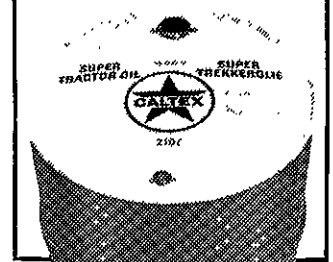

*THE OIL FOR THE EIGHTIES.
AND ONWARDS.*

18

sure ways to sweeten your operating costs



Molyslip is a wholly owned South African company, manufacturing in South Africa a comprehensive range of specialised lubricants and allied chemical products

Active in this country for more than 25 years — and continuously applying up-dated technology into product make-up has positioned Molyslip as an acknowledged leader in its field.

When reputation and profit are at stake, why settle for anything less?

MOLYSLIP

MOLYSLIP 'E'
MOLYSLIP 'G'
ENGINE FLUSH
GASOLINE ADDITIVE
MULTIGLIDE
QUICK START
RADIATOR FLUSH
RADIATOR LONG LIFE
COPASLIP
SLIPCLEAN
COMBAT
ANTI-MIST
RB-2X
LIQUID GREASE
MULTI-PURPOSE GREASE
HOUSEHOLD OIL
SILICONE SPRAY AND PASTE
S.R.A.

MOLYSLIP, P.O. Box 7294, Johannesburg 2000. Telephone (011) 786-2210. Cape Town (021) 21-6725. Durban (031) 37-4388. Bloemfontein (051) 31-4286

EVERY EASY WAY TO WEIGH

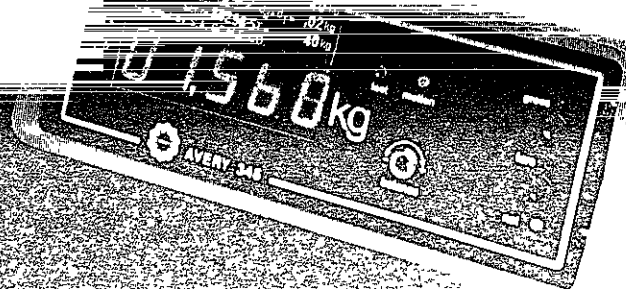
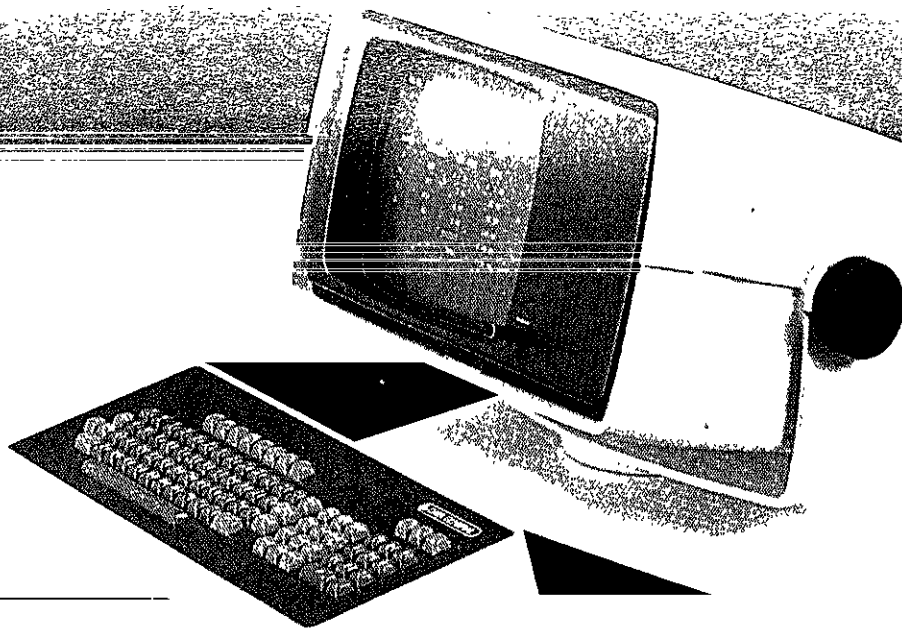

Whether you are weighing two 25kg sacks or a whole truck load. The sugar industry can rely on the space age technology of S.A. Scale in association with the international Avery Group.

Consider the efficacy and efficiency of the Servo Balans Electronic Duplex Weigher. Quickly, easily, and accurately, it can weigh a shipload of sugar, a trainful of coal, asbestos or even meales, and pass the information through to a computer for a complete and permanent record.

Just one of the modern and comprehensive range of electronic weighing and balancing machines available through S.A. Scale. Machines which can benefit YOUR industry. Because they make weighing such a simple matter.



**S.A. Scale Co
Pty. Ltd.**

**Although we carry your cargo far and wide,
we are anchored in South Africa.**

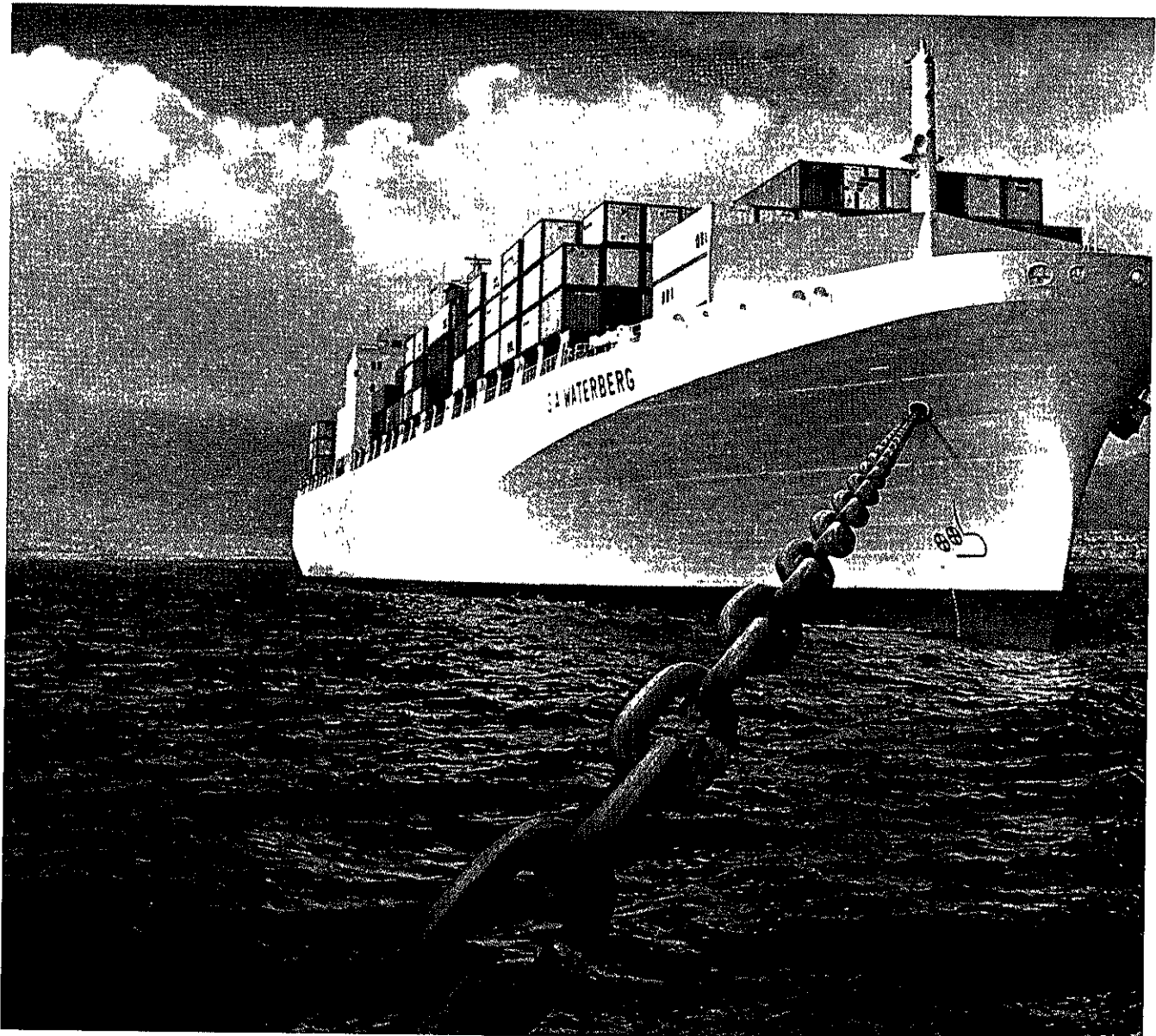

8335 EFR

North America. The Mediterranean.
Europe. The Far East. Safmarine
extends South Africa's trade links
around the world.

But we are as indigenous to South
Africa as Natal sugar cane, Sishen
ore, Witbank coal or Elgin apples.
Which is why we understand
the needs of South African
shippers best.

And because we are anchored
here, our earnings stay here too —
saving vital foreign currency for
South Africa.

**Ship SAFMARINE.
One telephone call will get us
working for you**

Head Office: Cape Town.
Offices and Agents worldwide.

SAFMARINE
SOUTH AFRICAN MARINE CORPORATION

Bulk supply for Reef

The South African Sugar Association's bulk delivery system, to supply refined sugar to manufacturers in the Pretoria-Johannesburg-Vereeniging areas, is nearing completion.

The curing plant at Hulett's Refineries (designed to stabilise the moisture content of the sugar to prevent caking during transit and storage) is almost ready to start operation. And the three Germiston

storage silos, with a capacity of 2 500 t each, should be completed by June.

There has been a slight delay in the start-up time, originally planned for June 1. The system will now get under way around the end of June.

According to the Association's domestic market manager, Frans Oosthuizen, the hold-up was caused mainly by a delay in the delivery of the special 24 t bulk road tankers and the modification of the SAR bulk sugar railway trucks. The basic railway units are used on the raw sugar delivery route from the mills to the Durban port sugar terminals. But, for the Durban to Germiston refined sugar haul, the hatch systems have had to be changed to make the trucks airtight to prevent caking during the journey.

An air slide system will also be added to the trucks. This unit floats the sugar on an air cushion to allow easy discharge down the off-loading chute.

The road tankers, which have also been specially built, are similar, with sealable hatches and air-compression off-loading.

The Association's plan is based on operations in the US and Europe, where bulk sugar delivery is used by most large manufacturers.

The main advantage of the system, says Oosthuizen, is that it allows manufacturers of soft-drinks, sweets, confectionery, canned fruits and the like, to institute an in-line system to achieve a higher production rate.

He points out five other benefits which manufacturers agree are viable cost savings:

□ Daily deliveries will reduce the cost of stockholding;

□ The present bagged-sugar storage areas can be used more productively for finished product warehousing;

□ The silo system saves factory space;

□ A major saving in loss from pilferage, contamination and the breakage of bags; and

□ A substantial reduction in the labour force required for off-loading and in-factory handling of bagged sugar.

The manufacturers' main worry has been the capital cost of installing the silo system in their plants.

"But," says Oosthuizen, "the association has devised a grant scheme which should cover most of the cost of the receiving silos and piping, if not the in-factory set-up. But in the less technically complex set-ups, the grant may suffice to cover the whole capital cost."

"We are asking manufacturers interested in the system to submit firm figures for their sugar demand for the five years from June."

"We will then give them a cheque for the R3/t grant, based on this five-year estimate, on completion of their receiving and storage units."

Because of the delay in the original starting date, the full five-year grant will be available to all applicants up to August 1. If a manufacturer delays his start-off time to year two, his eligibility is reduced to a four-year grant. The same applies down the line in years three, four and five.

The grant system, say a number of manufacturers, has made the scheme economically viable for even some of their smaller plants.

The R5m initial capital cost will show no return — it is regarded as a subsidy by the Association. With a 40 000 t a year throughput, the system will break even on operating costs.

This minimum tonnage is expected to be met during the second year of operation. And the association's calculations show the offtake reaching 60 000 t a year in the third year.

The tonnage has been worked out as the annual minimum required to justify the establishment of the system.

If this figure can't be reached, because of smaller demand for bulk delivery than hoped for, the plant can also double up as a bagging operation.

Despite the capital cost of the system, there is a major advantage to the Association in the freightage cost of hauling sugar in bulk. The SAR charges at rate nine for bagged-sugar, but bulk is charged at rate 11.

The Sugar Association has arranged a scheme which will provide technical assistance for the layout plans and assist manufacturers in the receipt, storage and handling of bulk sugar.

TRANSPORT COSTS

The transport of cane has always been a major ongoing cost in the SA industry.

Transport has also caused a number of headaches for the Sugar Association in trying to level the returns to each grower.

There is little controversy in this area at the moment, but cost control remains vital.

The only noticeable change in method has been the significant growth of the use of the heavyweight road trucks. These "hilos" have increased their share of the haulage by more than 10% in the last seven years. This has been mainly due to an improvement in the mills' handling facilities from trucks and the growers' loading facilities and machinery. There has also been the rising cost of railage, and the unsuitability of smaller, unspecialised vehicles.

The figures recorded on the chart give an overall breakdown of the financial position of the industry's transport operation.

CANE TRANSPORT

Season	Total deliveries (in tons)	Total costs (R)	% Delivered by				
			SAR	Heavy road vehicles	Lorry	Tractor	Tram
1974/5 ...	16 901 669	24 879 317	12,6	48,0	9,8	14,7	14,9
1975/6 ...	16 821 826	28 628 504	12,0	49,9	9,0	14,6	14,5
1976/7 ...	19 228 070	36 169 325	12,1	53,6	7,5	13,9	12,9
1977/8 ...	19 017 465	40 946 883	12,2	55,1	6,7	14,4	11,2
† 1978/9 ...	18 826 346	45 320 677	12,0	54,7	9,7	11,1	12,5
1979/80 ...	18 322 254	54 209 923	10,0	59,6	9,0	10,5	10,9
‡ 1980/1 ...	14 070 169	45 411 830	10,7	58,4	5,8	10,7	14,4

† Introduction of control of production

‡ Crop affected by drought conditions

PERCENTAGE OF TOTAL COSTS

Season	SAR	Heavy road vehicle	Lorry	Tractor	Tram	Transshipment
1978/9	13,4	48,2	4,6	6,2	15,3	12,3
1979/80	9,6	54,2	5,0	5,9	13,0	12,3
1980/81	10,5	51,5	4,6	4,8	18,9	9,7

STRONGER FERTILISER PAYS



For savings galore!

- FEWER TONS - LOWER RAILAGE
- LESS HANDLING - LESS LABOUR
- FEWER STOPS - QUICKER PLANTING

BONUS[®]

PIONEERS IN HIGH CONCENTRATE FERTILISERS

REG. K245 WET 36/1947

Bonus Fertilisers (Pty) Ltd. ☎ 39-5861 ☒ 32171 Braamfontein 2017

A devastating drought

The sugar industry lost about R270m gross revenue in the 1980-1981 season, because of the effect of the worst drought in a hundred years

Before the end of the 1979-1980 season, it was apparent that the sugar industry was heading for the worst drought on record.

The end season (May) rainfall figures showed a disturbingly low percentage of the mean amount. The highest was the 74% total in Empangeni, where the June 1979 to May 1980 rainfall was 876 mm, compared to the long-term average of 1 186 mm. The lowest was in the area around Amatikulu, which showed 56% of mean rainfall, with a miserly 593 mm compared to the long-term average of 1 050 mm.

This was, unfortunately, a follow-up to the previous season, when rainfall was also well below average.

And, from the cane growers' point of view, the distribution was also very bad in the 1978-1979 season. The bulk of the rain fell in October, 1978 of that season and, for the farmers, this is not a prime growing month.

In the 1979-1980 season, rainfall in the prime growing months was again abysmally low. Indeed, taking the four worst growing season droughts in the industry's recorded history, this was 7,5% below the previous worst.

The total rainfall in the drought of September to March 1887-1888 was 544,4 mm; in 1916-1917 it was 522,3 mm; in 1946-1947, 785,8 mm; but it fell to the bottom in 1979-1980 with only 483,2 mm.

On the social side, the Zulus living in the tribal areas next to the sugar belt were also faced with a potentially disastrous situation.

As the months from the start of the drought passed, the outlook got steadily worse. Streams dried up, boreholes were running dry, and Zulus in some areas were having to walk up to 10 km to draw water. They were further limited by their ability to transport, or, in most cases, to carry the water supply.

The sugar industry, along with other helpers, tried to ease this lack. But, though they transported water to the tune of 1 500 000ℓ a day, between July 25 and the day when rains came in September, they couldn't help their own crop loss.

This loss was epitomised by the eventual results of the 1980-1981 season. The potential production of 2,2 Mt of sugar, attainable with average rainfall, was reduced to 1,61 Mt.

And this occurred when the industry was facing a world sugar price at a five year peak, and the suspension of quotas imposed by the International Sugar Agreement.

With the direct result of the drought, and the secondary effects of the Eldana borer and other pests and diseases caused by drought stressed cane, the industry faced a loss of about 600 000 t of sugar in that year. This figure is estimated against the hypothetical case of each hectare planted, giving the average yield that could be expected if the industry had experienced average rainfall conditions. It also allows for the Utopian circumstance of no moisture stress and no pest or disease effect.

Ernie Morrison, GM of the Canegrowers

INSULATION CONTRACTORS (PTY) LTD.

PO Box 3262, Durban

Telephone 32-6426/7/8. Telex 6-2652

CONTRACTORS: Complete Sugar Mill Lagging and Cladding

FORREST GUNITING COMPANY

Office telephone 66637

Works telephone 65015

We are proud to be associated with the FIRST GUNITED BOILER in the
Sugar Industry

We serve the Sugar Industry with confidence as suppliers, designers,
and/or contractors and manufacturers of
Rope Lagging Material

SUGAR KEEPS US ENERGETIC IN MORE WAYS THAN ONE

DROUGHT UNABATED

The 1981-82 season is facing a further spectre of drought, with minimal rainfall since February.

Cane Growers Association president, Ernie Morrison, does not view it as being as severe as last season's drought, but there is still concern at the low rainfall.

December and the first part of January were bad. Then the February rains gave the growers hope. But March rainfall was badly down and, as there wasn't a good fall over the Easter period, the season is going to suffer. Autumn and Winter in Natal and Zululand have always been the dry periods of the year.

The February figures fell just below the long-term mean, but the rainfall throughout the year has been very erratic. January's figure, for example, was relatively good, but the bulk of this rain fell on the last two days of the month. Most of this short-term fall ran off, or was dried up by the following hot days.

The most dry area, according to Dr Gerald Thompson of the Experiment

AVERAGE RAINFALL

For the areas in the sugar belt

	Dec	Jan	Feb	Mar
	(mm)			
South Coast.....	76,2	183,6	78,3	45,5
North Coast.....	93,9	191,7	142,9	40,8
Midlands	92,5	117,3	98,9	67,0
Zululand	79,0	163,6	112,1	49,9

The worst two areas

Amatikulu	63,4	227,5	186,6	29,8
Nyoni	90,9	202,6	215,2	48,8

Station, was around Amatikulu. Here the dismal March figure of 29,8 mm compares with a long-term mean of 126 mm.

"And there was so little rain in March in many areas that many of the cane fields are now getting depressingly brown," he said.

Another dry season and falling world sugar prices mean that this highly export orientated industry is likely to face an increase in the R130m debt incurred over the last four seasons.

mally need two years to produce a crop, and planting can only be done after good spring rains.

□ Unless Eldana borer is brought under control, areas infested will probably have reduced crops when the cane is ready for harvesting.

Even with the promising rainfall of the early part of this year, there is no doubt that the 1981-1982 crop will also be heavily down. The estimates by the industry currently point to a 1,8 Mt crop, as opposed to the norm of 2,2 Mt.

Morrison also gauged the effects on the growers in general terms.

"Many growers," he said, "in the worst affected areas (mostly inland from Empangeni) were down to as low as 25% of their normal production.

"Averaging the canegrowers' income at about R150 000, and their expenses at about R120 000, we calculated the loss factor to the growers who were worst affected.

"With a 25% drop, the net farm income fell by approximately R28 000; at 30% by about R38 000; at 40% by about R56 000; at 50% by about R74 000; and at 60% by about R92 000.

"As you can see, with the second year of drought, the growers in certain areas were in a critical position. In addition, the gross loss of profit to the entire industry was estimated at about R220m.

"The overall loss could have been applied as the first R90m to satisfy the cost of production and to permit growers and millers to recover in full their allowed returns on capital. We could also have repaid the industrial loans of R50m. And the R80m balance could have been invested in the Price Stabilisation Fund."

But none of these applications could be fulfilled. The industry had to go out on a borrowing spree to meet its requirements and to obtain individual emergency loans for the farmers who had lost more than 40% of their normal crops.

In the worst-hit area, from Tongaat, 200 km north to Hluhluwe, the number of growers with more than a 40% loss was high.

Among the 890 registered white farmers, 261 were in the high-loss position. Of the 1 661 coloured and Indian growers, 1 012 fell into that category.

Nationally, the total number of white and Indian growers is 3 722. Excluding the 1 149 in the irrigated areas of Malelane and Pongola, and those growers in the Natal South Coast and Midlands areas, the balance in the drought plagued areas is 2 573. Of this balance, 1 611, or 63%, have lost more than 40% of their normal crops.

The black growers do not submit individual crop estimates, so it is not possible to ascertain how many were similarly affected. But the estimate was that the average yield in the area was only 55% of the normal. When the government was informed of the dangerous situation, it

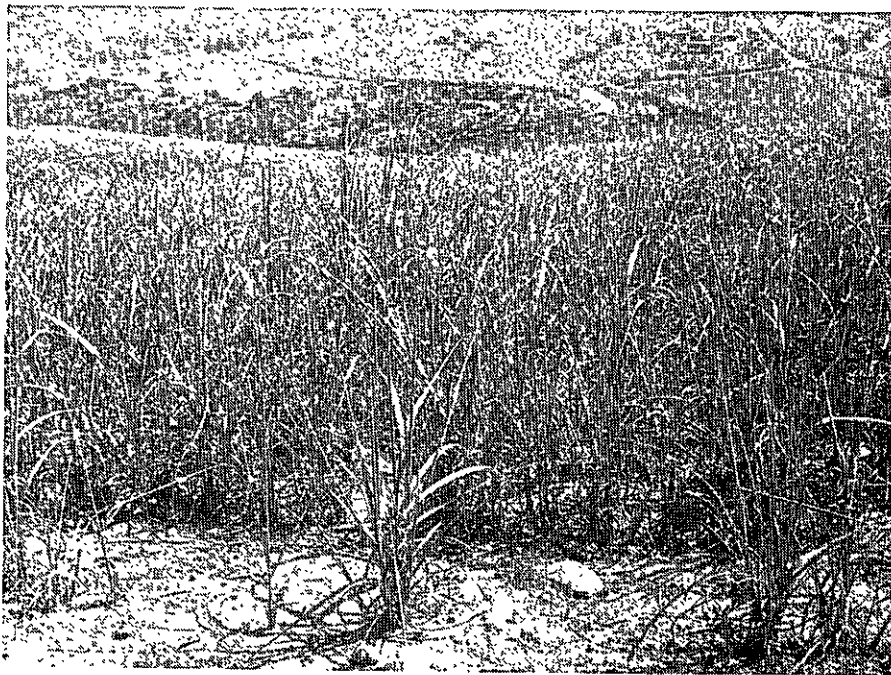

The strain of droughty weather

Association, says the poor seasons will have a significant recurrent effect at least on the following crop, as ratoon cane (the further growths from the original seed-cane) will show a lower yield in the next season.

The longer-term effects have been clearly pointed out by the following statements by the Sugar Association.

□ The cane may not ratoon due to dead roots.

□ The extent of dead roots will not be assessable until at least 40 mm of rain has fallen.

□ It may take up to four years to replant an area, depending on the equipment and seed available.

□ It may take six years or more, depending upon weather conditions, for a rehabilitated area to produce its optimum crop.

□ Areas most affected by drought nor-

**Add
Stewarts+Lloyds
spares and service
to this range,
and you've got
the whole picture.**

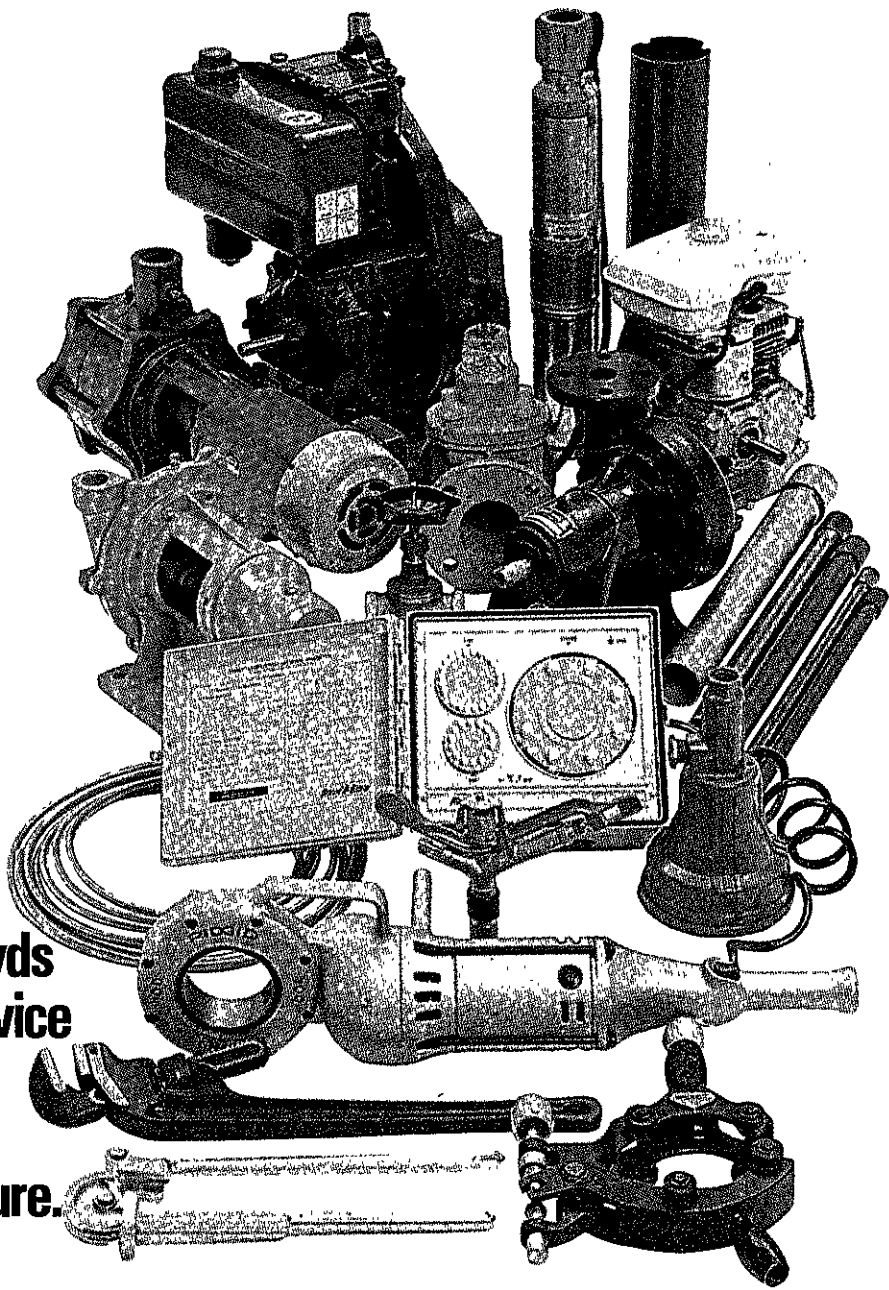

Stewarts + Lloyds meets the needs of many industrial concerns. With a comprehensive range of products, extending from pipes, fittings, pumps, hand tools and irrigation equipment to valves and generating sets. Plus the right approach to ensure that you get the personal service and assistance you can always expect.

Contact your local branch of Stewarts + Lloyds any time, or call if you prefer. Both ways gain you expert, professional attention.

 **Stewarts + Lloyds**
Stewarts + Lloyds Trading (Pty) Ltd.

Branches at Johannesburg, Pretoria, Nelspruit, Pietersburg, Vereeniging, Durban, Pietermaritzburg, Dundee, Empangeni, East London, Bloemfontein, Kimberley, Klerksdorp, Upington, Cape Town, Port Elizabeth, Ojirwarongo, Welkom, Windhoek

BARKER, McCORMAC 5719





**SUGAR ONE OF OUR GREATEST
NATURAL RESOURCES**

**THE SUGAR MARK SYMBOL
IS ONE OF THE MOST IMPORTANT
INDUSTRIES IN OUR NATION**

If your schedule
says "move it" –

HULTRANS

can take it !



Hultrans
...the prime mover
in heavy haulage

 A Member of The Huletts Group

Call Hultrans Reef (Alrode) 8642070 or Durban 453141

HT 501

RAINFALL DATA

1978/79, 1979/80 and Long Term Average

Station	June 1978-May 1979		June 1979-May 1980		Long term Average mm
	mm	% mean	mm	% mean	
North coast					
Mt. Edgecombe	737	81	642	70	914
Maidstone	818	88	637	69	925
Gledhow	953	100	607	64	953
Darnall	779	78	609	61	1 003
Zululand					
Mandini	750	73	662	65	1 021
Inyoni	847	83	670	66	1 021
Amatikulu	995	92	593	55	1 083
Eshowe	1 080	92	848	72	1 176
Nkwalini	598	82	403	56	725
Empangeni West	845	89	665	70	952
Empangeni	928	84	876	79	1 106
Ukulu	832	85	708	73	975
Kwambonambi	882	81	666	61	1 088
Mtubatuba	781	89	590	67	881
Hluhluwe	704	93	484	64	753

Figures supplied by Experiment Station, Mount Edgecombe

sent representatives to examine the drought stricken areas.

The then Minister of Industries, Commerce and Consumer Affairs, Schalk van der Merwe, and Marais Steyn, Minister of Community Development, Coloured Relations and Indian Affairs, visited Natal and Zululand on May 5 last year.

They were accompanied by representatives of the Department of Industries and the Department of Agricultural Credit and Land Tenure.

Cabinet approval for an emergency loan was granted on May 14.

The assistance was negotiated through the Jacobs Standing Committee on Agricultural Finance and funds of R15m were put aside to cover the claims.

The eventual amount applied for was around R13m.

While the Land Bank was available as the loan medium, it required an adjustment of its agricultural credit system to deal with a large number of individual applicants. Loans to other agricultural industries are placed through the co-ops. But the sugar industry is not based on the co-op system and many problems arose.

However, this was eventually rectified, and the loans are now being distributed, and being utilised.

Assistance to black growers is being dealt with by the Ministry of Co-operation and Development and the KwaZulu government.

The few coloured growers are being assisted by the Department of Coloured Relations.

In the case of white and Indian growers, the loans are handled by the Land Bank and the Agricultural Credit Board.

If the Land Bank is faced with a debt ratio that has deteriorated to such an extent that it can no longer provide credit, the usual facilities provided by the department will be available.

These will include long-term loans, partial, or complete consolidation of debt, and production loans.

So far, the loans from the Land Bank take the form of seasonal production credit loans and replanting loans. Both are granted at a government subsidised interest rate of 5%.

The production credit loans are matched with the return from 60% of the normal crop and are repayable on January 15 1982. But there is an allowance for renewal, at the unsubsidised rate of 8%. In other words, growers had to absorb crop losses of up to 40%.

The replanting loan is for seven-years. Interest is capitalised in the first two years and redeemable during the remaining five in five equal amounts.

The Eldana disaster

Control measures to combat the fast-spreading Eldana borer are being tested urgently

The borer, *Eldana saccharina* Walker, is spreading at an alarming rate.

And the disastrous drought in Zululand during the last two years has made things worse. This is because of the borer's preference for mature and drought-affected cane.

The areas around Gingindhlovu, Zululand, are the worst affected and are facing more infestation. But the borer has now spread in pest proportions as far south as the Tongaat area. There have been two instances of borer in cane on the South Coast at Margate and Park Rynie. While these two incidents have been described as "minor," there is now a distinct feeling that there could be more outbreaks in the south.

The coastal region as far south as Port Shepstone is an ideal environment for the borer's favourite wild host plant, *Cyperus immensus*. And the migration of Eldana from this host to the adjacent

sugarcane fields "is to be expected sooner or later," according to Dr Gerald Thompson, director of the Experiment Station at Mount Edgecombe, where an urgent investigation into control methods is being conducted.

There is now a ban on the movement of cane from affected areas to those currently free of the pest. A line has been drawn from north to south down the 16°C July mean daily temperature isotherm, effectively defining the boundary between the coastal areas and the inland highlands.

The Council of the SA Sugar Association has also decided on a west/east division line from Cato Ridge to Durban.

No cane can be moved from north to south past this line, nor can cane be moved from east to west of the highland boundary line.

This is a particular relief for the cane farmers in the Natal Midlands, who "were in dire fear of Eldana being introduced

from the coastal areas," according to council member, Volly van Breda, chairman of the Union Co-operative Bark and Sugar Co of the Midlands.

Regarding the control of Eldana in affected fields, the old idea of burning is no longer mandatory. Surveys and experiments have shown that Eldana eventually infests burnt and unburnt fields equally heavily in the succeeding ratoon crop (succeeding crop from original seedcane).

The latest method of treatment is pre-trashing (removing the dead leaves) of cane which has an incidence exceeding 15 Eldana larvae per 100 stalks. This inhibits growth in Eldana numbers because the borer moth has a preference for laying its eggs in dead leaves.

Pre-trashing is best carried out several months before harvesting and can lead to the numbers of the pest being reduced by more than 60%, as was shown in one of the trials by the Experiment Station. The average results of six completed trials indicate that a 40% reduction in Eldana numbers can be expected, involving a saving of around 30% in the number of damaged stalks.

W E C **ULTIMATE NSTRUMENT ONTRACTORS (PTY) LTD**

INSTRUMENTATION AND ELECTRICAL
DESIGN
CONTROL PANELS
MOTOR CONTROLS
INSTALLATION
COMMISSIONING
SERVICING

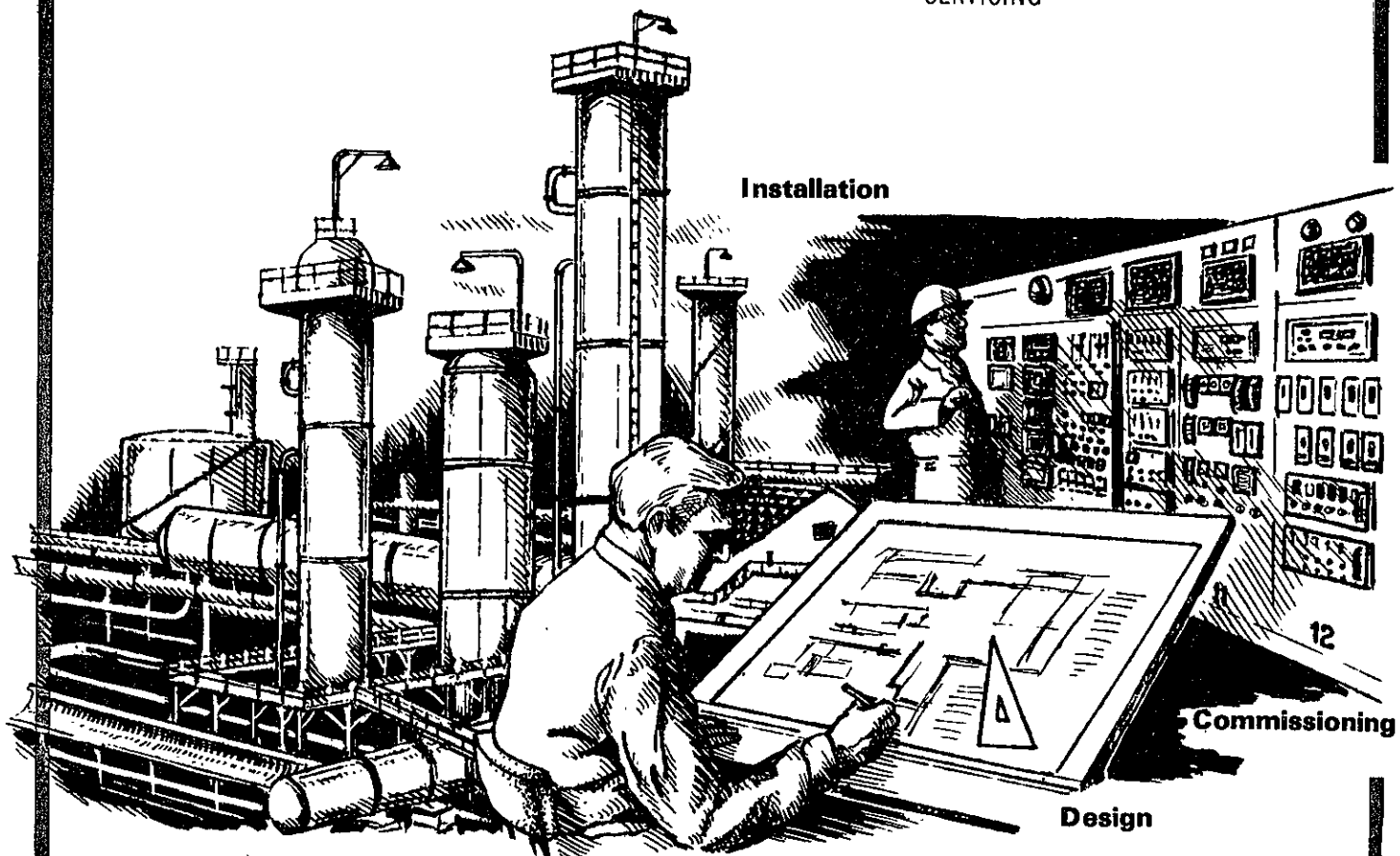

WE COVER SOUTHERN AFRICA

DURBAN

152 VOORTREKKER STREET,
JACOBS
PO BOX 12245,
JACOBS 4026
TELEPHONE: (031) 482561
TELEX 6-4141

W E C

JOHANNESBURG

760 ANDRIES STREET,
WYNBERG
PO BOX 391553,
BRAMLEY 2018
TELEPHONE (011) 7861077
TELEX 4-25036

CAPE TOWN

195B VOORTREKKER ROAD,
MAITLAND
TELEPHONE (021) 513096/7
TELEX 5722215

‘ IT’S NOT ONLY
SUGAR THAT
GIVES US OUR
BOUNCE’

Hulett's

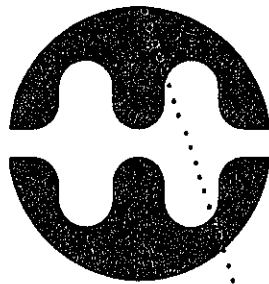

Irrigation also helps to control the borer. Eldana infestation is worst in old cane (more than a year old) and in stressed or droughted cane. By irrigating the cane, it can be harvested at a younger age and moisture stress is largely averted.

This control has been most strongly advised for seedcane nurseries, preventing Eldana spread in the seedcane and producing a healthier planting stock.

Although the North Coast situation is now described as "incurable," great emphasis is being placed on the search for biological control agents.

Both parasites (insects which lay their eggs in one stage or another of the Eldana cycle, and whose young then feed on the Eldana) and predators are now being studied in depth.

These programmes, which have been conducted over the years, have been accelerated dramatically and the Sugar Association has set aside R450 000 this year for surveys and experiments.

The most effective results of these two biocontrol methods are likely to be those concerning parasites. The Experiment Station has had an entomologist searching West Africa for suitable parasitic insects which are mean enough to cope with the South African borer.

So far entomologist Hugh Hastings has sent back two of the eight listed parasites. A small wasp, called *Telenomus*, is presently being cultured in the Experiment Station. There is also a small culture of the even smaller *Trichogramma* wasp, but this is more difficult to culture under artificial conditions.

The station has two West African flies which parasitise the Eldana larvae and are similar in type to those used for

biocontrol in South America. But these are also difficult to rear under artificial conditions.

In addition, experiments will soon be conducted with a *Trichogramma* wasp

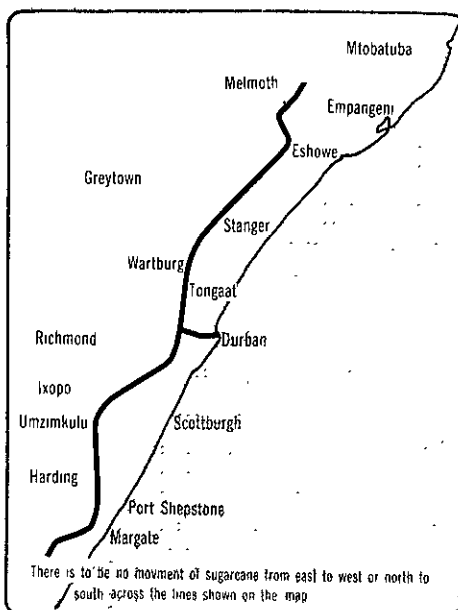

parasite — brought in from Taiwan — by means of mass releases in the field.

The risk of introducing a possibly dangerous species is taken into consideration during quarantine procedures in Pretoria.

The possibility of encouraging existing predators is also a viable weapon against the borer's destructive capabilities.

It is now known that many small arthropods, such as ants, spiders and roaches which frequent cane fields, are important biocontrol agents in the fight against the

voracious cane-consuming Eldana.

Using a serology technique (which uses an antiserum to indicate whether the stomach contents of these insects contain Eldana remains) to identify the most effective predators, the Experiment Station has made some interesting observations.

The most consistent predator is the ant, *Dorylus* sp, which is unfortunately less common than most ant species. Positive results were obtained in 62% of the numbers tested so far. However, the most common cane field ants have not yet given many positive results.

Among the spiders tested, there have been more positive results from the hunters than from the web-catching type.

But testing of both control methods is at an early stage and results cannot be expected to produce an efficient combatant overnight.

Insecticides are being studied in the anti-Eldana fight as well. But the major danger in using chemicals is their effects on the other insects which may, in fact, be more effective controls.

"But," says Dr Thompson, "if the problem gets bad enough, insecticides may be needed."

The trials to date have given no indication that treatment with chemicals could be economically justified.

The five-year test programme on insecticides, which was run on a part-time basis until recently, now has one of the Experiment Station's experts working full-time.

There has also been a suggestion that a more resistant variety of cane might be an effective control. But producing new hybrids is a lengthy process. Up to 14 years, with the planting of 150 000 seedlings a year, is needed to develop a new strain.

And the unfortunate thing about the newer varieties recently released (J59/3, N11 and N52/219) is that, in experiments, they have supported significantly more Eldana than the older varieties (NCo 376 and NCo 310).

Sex attractants are also being looked at to assess whether pheromones have some control possibilities. Pheromones, once synthesised, might be used to trap the females and therefore reduce the egg-laying capacity of the species.

Pheromones can also be used as a monitoring device and augment the light traps currently used.

Professor Paul Burger, of the University of Stellenbosch, who has previously synthesised other pheromones, is now working on the Eldana moth.

Despite all the methods which have shown some hope, the Experiment Station can promise no overnight control for the rampaging Eldana. And the feeling in the industry is that there is likely to be a continuing spread of the pest for some time to come.

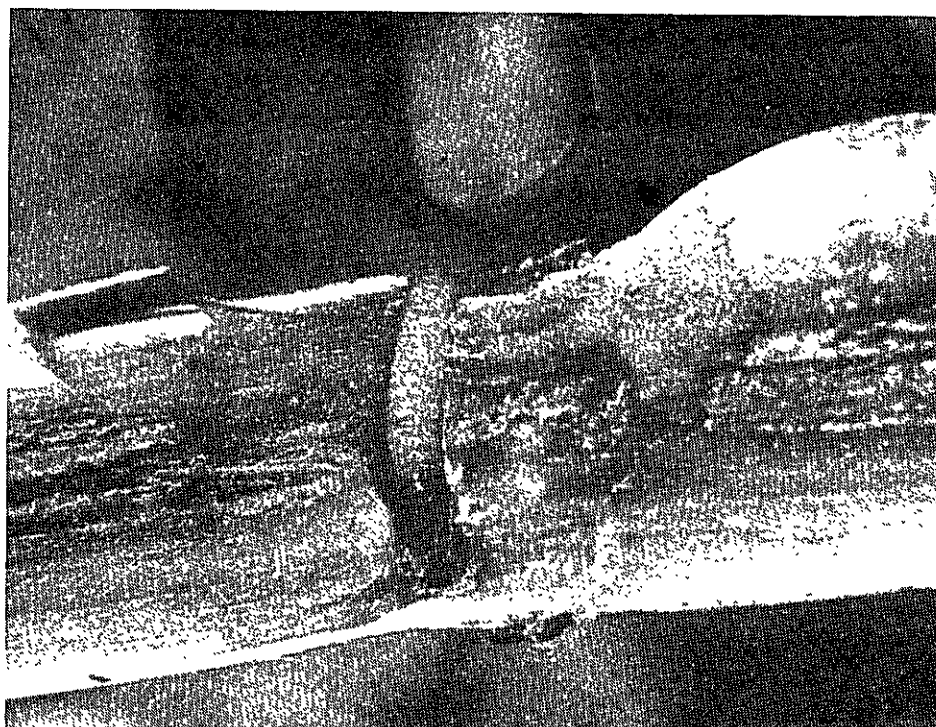

It's only too clear how hungry an Eldana can be

DIURON

THE BACKBONE OF ANY WEED CONTROL PROGRAMME IN CANE

Manufactured in South Africa by:

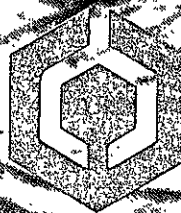

AGBRO

Agbro Diuron Reg. Nrs. 1793 & 1801

HERE'S THE WORLD'S FINEST FARM MACHINE SYSTEM.

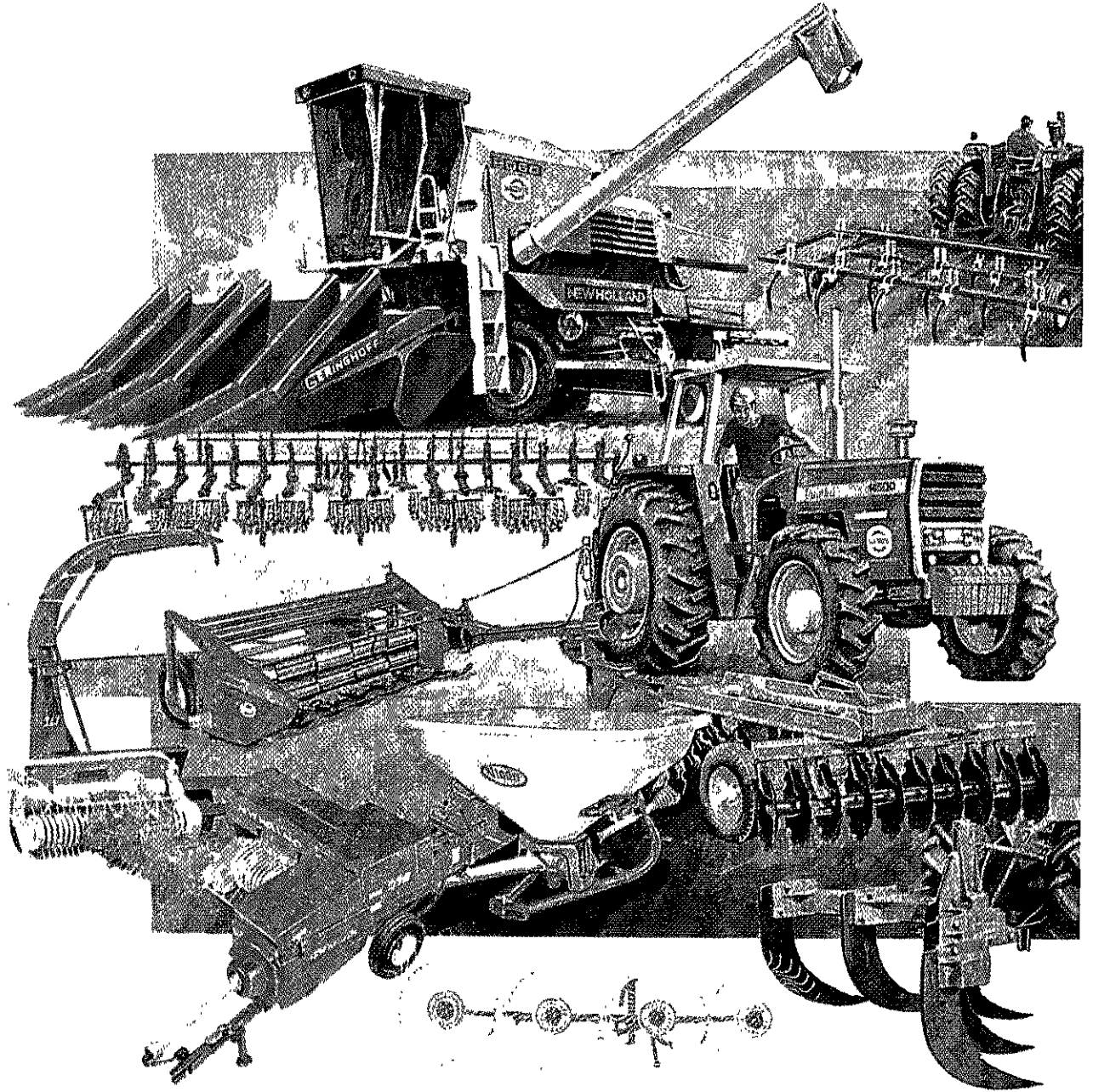

SPERRY-NEW HOLLAND  DROPSKY  VICON  IMCO  GT  BRILLION
 Landini CLAYSON Lilliston  MAGTEC  AKTIV  GERINGHOFF SA WONDER

FROM SOUTH AFRICA'S INDEPENDENT FARM MACHINE COMPANY.

We've built the complete farm machine system for you.

By backing the world's best products with a sales, service and parts network of 31 branches plus more than 40 authorised Malcomess dealers.

When you buy Malcomess, you buy machines selected for your farming needs, and tested in South Africa under the toughest possible conditions.

You also get:

- *THE MALCOMESS GUARANTEE
- *RELIABILITY
- *SERVICE
- *PARTS
- *TRADE-INS
- *FINANCE

Farmers who use Malcomess products rate them best. We'd like you to rate our service best too.

Put us to the test.

EVERY FARM MACHINE YOU NEED.

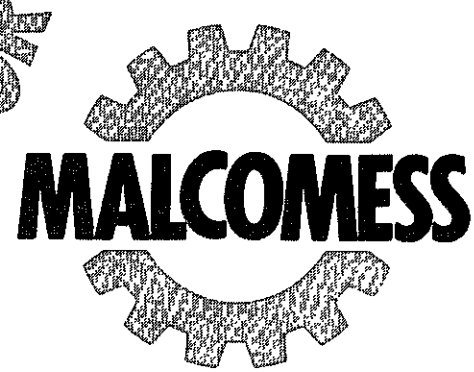
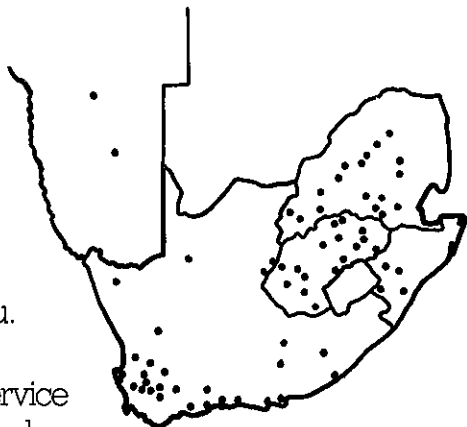

Balfour, Bethelam, Bloemfontein, Bothaville, Bultfontein, Delareyville, Delmas, Ermelo, Estcourt, Groblersdal, Hartswater, Heidelberg (Cape), Isando, Kroonstad, Ladybrand, Lichtenburg, Marquard, Middelburg (Tvl.), Moorreesburg, Ottosdal, Parow, Parys, Pietermaritzburg, Reitz, Riviersonderend, Rustenburg, Senekal, Standerton, Ventersdorp, Viljoenskroon, Wesselsbron.

UNICORN... experience in action

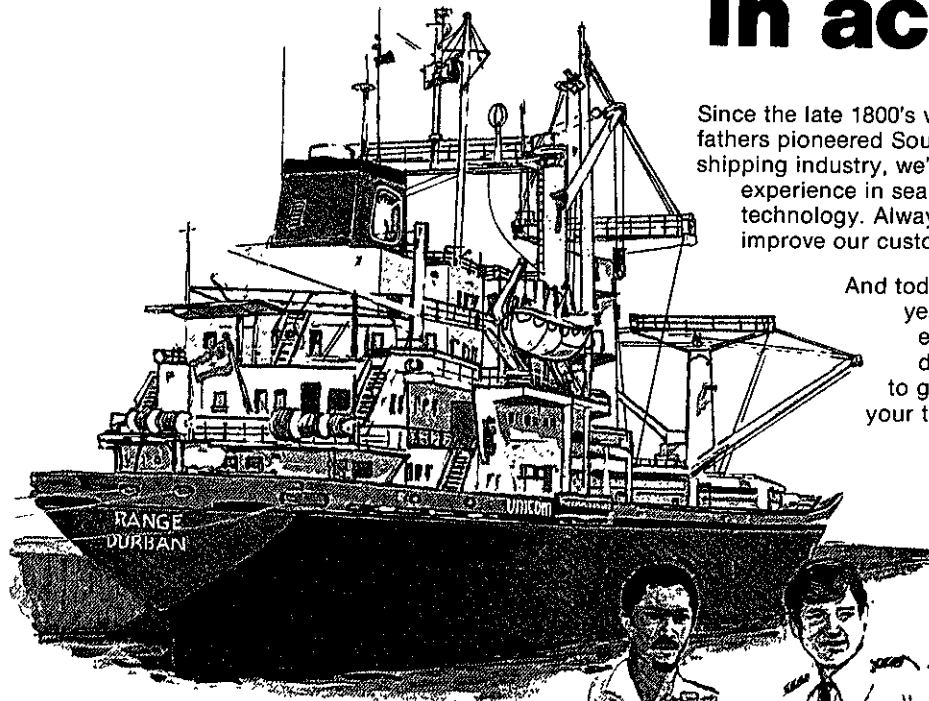

Since the late 1800's when our founding fathers pioneered South Africa's coastal shipping industry, we've been accumulating experience in sea trade. Adding new technology. Always looking for ways to improve our customer service.

And today Unicorn's 90 years of shipping experience is at your disposal to help you to get the most out of your transport budget.

THE UNICORN SERVICE

Unicorn's service extends to all S.A. Coastal ports between Durban and Walvis Bay And to seven foreign trade routes*. With reliable and regular sailings performed by sophisticated vessels, capable of delivering a wide variety of containerised and break-bulk cargoes - safely and efficiently

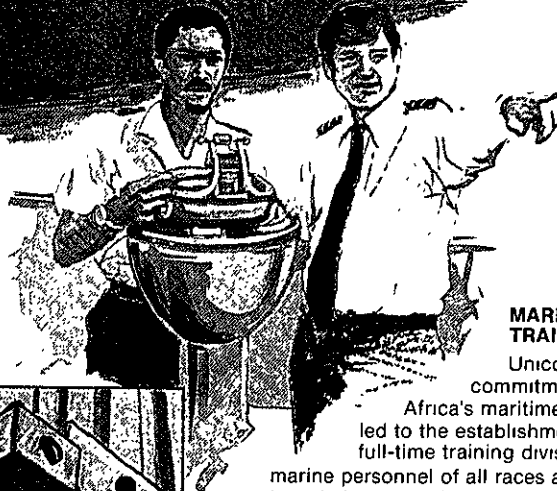

MARINE TRAINING

Unicorn's strong commitment to South Africa's maritime future has led to the establishment of a full-time training division Where marine personnel of all races acquire the knowledge and skills required for optimum performance at sea



CONTAINER DEPOTS AND SERVICES

Unicorn's rapidly expanding, door-to-door container service is backed by comprehensive storage and repair depots in all S.A. ports and in Johannesburg. Depots handle the complete range of repairs, all conforming to the requirements of the International Standards Organisation. Durban and Cape Town depots are Lloyd's approved.

CUSTOMER SERVICE

Unicorn encourages a first class customer liaison service. Operated by direct representation through our own Johannesburg Office, and a country wide network of exclusive Agencies - Grindrod Shipping. Our aim is to offer advice on how you can benefit from our extensive range of services. To provide you with the best and most economical method of transporting your goods by sea. So take a good look at your future with the people who know shipping - call your local Unicorn representative for full information and advice.



*THE UNICORN FOREIGN SERVICE
Indian Ocean Islands, Mahe, Sri Lanka, Israel, East Africa, West Africa and the East and West Coasts of South America

Ready to meet the demands of a growing South Africa.



UNICORN

UNICORN LINES (PTY) LIMITED

Telephone Durban 321451, Johannesburg 285540
Cape Town 211820, Port Elizabeth 29154, East London 24381

Lindsay Smithers U 1468

Sugar Survey. Supplement to Financial Mail May 22 1981

Worm's eye view

Root-feeding nematodes are causing major losses in cane crops

The cane-growing industry probably loses around 900 000 t of sugarcane each year because of stunting caused by nematodes.

Nematodes are small worm-like animals which live in the soil, in plants and in animals, as well as at the bottom of the sea. In fact, these worms exist almost everywhere there is organic matter and moisture. And every type of plant is attacked by one or more of the species.

In humans, nematodes are known as "roundworm" and cause diseases such as elephantiasis and hookworm. In the soil they are sometimes known as "eelworm."

Although these worms are not very noticeable, they exist in the same abundance as insects, if not more so.

While sugarcane appears to be fairly resistant to root-feeding nematodes when compared to many other crops, there is still a major yield loss each year caused by these worms.

Again, the drought has significantly increased the effect of these parasites.

Cane, when it is stressed by insufficient soil moisture, soon shows a serious reduction in yield because of the effect of drought, and the efforts of the worms.

Over 50 different species of 28 genera of plant-feeding nematodes, have been recorded around sugarcane roots, varying in size from less than 0.5 mm to 5 mm in length.

Of these 50 there are probably less than 10 species from four genera which are important as loss factors in sugarcane crops.

These have been defined by the Sugar Association Experiment Station nematologists, as species of the genera *Pratylenchus*, *Xiphinema*, *Meloidogyne* and *Paratrichodorus*.

Nowhere in the cane-growing areas is the soil free of this pest. But the damage it causes to crops depends largely on the composition of the soil.

Although more numerous in clay than sandy soil, the damage to crops is almost entirely restricted to sandy soil.

"This", says nematologist Vaughan Spaul, "is largely due to the poor nature of the soil for healthy cane growth, and the ease of movement of the nematodes in light sandy soil. The four main genera occur in almost every field of sandy soil."

"And the nematodes in this type of field can cause a yield drop of about 27%."

"This is roughly equivalent to losing 25 t of cane per hectare, and has been verified by a large number of field trial results."

Like the unbeatable Eldana borer, nematodes can be controlled, but not entirely eliminated by using nematicides — a pesticide specifically designed to fight the worms.

There are three registered products recommended for control in our canefields. One is Temik 15G, with aldicarb the active ingredient. Curaterr 10G uses carbosulfan. Both these can be used for plant and ratoon cane (which is the regrowth from the original seedcane planted). Third

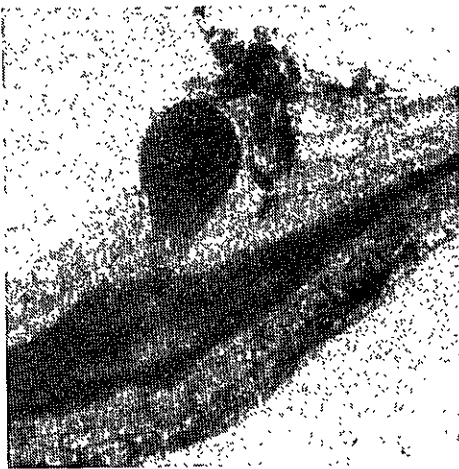

A nematode at the root of things

is Vydate L, with the active ingredient oxamyl, which is only used for ratoon cane.

Temik was first registered in 1971, with the other two being introduced more recently.

In high concentration all three kill the nematodes in the fields, and in low concentration they disorientate the worms.

The low concentration of 3 kg of active ingredient spread over one hectare is the registered rate of application most com-

monly used. The end result is to prevent the worms finding the roots, inhibiting production and to stop the males finding the females.

This control lasts for about six weeks. But this is sufficiently long for the root systems to proliferate enough to be able to resist most of the stunting effect of the worms.

The use of nematicides is a carefully balanced economic exercise. Nematicide treatment costs between R90 and R120 per hectare, using the registered rate of application. And dependent on the cash return per ton of cane, this amount must be balanced against what the loss would be if cane was untreated.

Surprisingly, there has been no correlation between the number of nematodes in the soil and the final yield of cane. So this cannot be used as an index of whether a nematicide should be used. Instead, the current practice is to base the viability of nematicide application on the symptoms of damage to the infested fields.

As with other pesticides, nematicides have led the growers to question whether there is any long term detrimental effect on soil organisms.

But research by nematologists has dispelled this fear.

The nematicides certainly kill other animals by affecting the function of their nervous systems. Soil dwelling animals, such as insects and worms that ingest or come into contact with sufficient quantities of these chemicals, will die. And animals that feed on the roots of the plants treated with these systemic pesticides may also die.

However, there is probably little or no long-term detrimental effect on the soil fauna, as all three nematicides are soon degraded in the soil to non-toxic compounds. And the animals that die are quickly replaced by recruitment from those that survive, and by recolonisation.

There is no accumulation of toxic chemicals in body tissues, or in the soil, as is the case with organochlorine pesticides.

Disease threat

A number of pests and diseases threaten the sugar industry

An example of the serious effect diseases can have is the outbreak of sugarcane "rust" in Cuba. This disease ravaged their crop for a number of seasons. The grow-

ing incidence of disease problems in SA's fields is worrying the local sugar industry.

Last year, Ian Smeaton, chairman of the SA Sugar Association, sent a disturb-

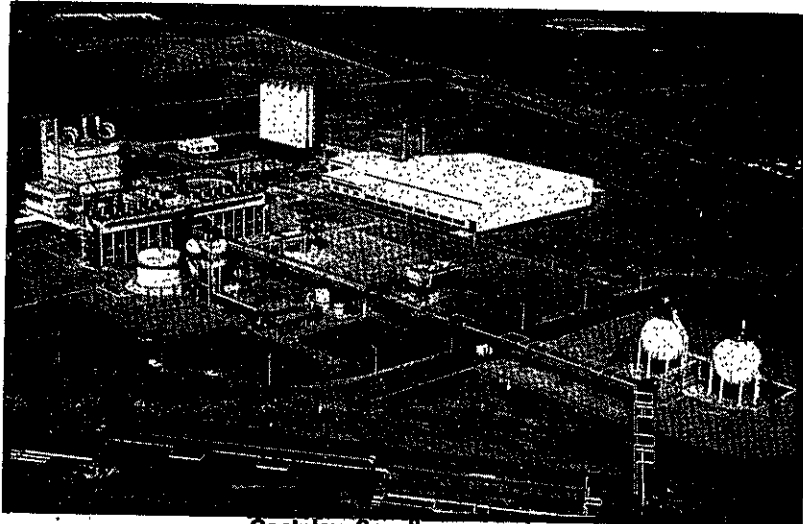

Coalplex, Sasolburg



**DESIGN AND CONSTRUCTION
OF PROCESS PLANTS**

Simon-Carves Africa is equipped to undertake turnkey projects or will offer individual engineering services for:—

Chemical, Metallurgical, Mining and Environmental control plant.
Civils & Mechanical Erection, Electrical & Instrumentation Installation.

SIMON-CARVES AFRICA (Pty) Ltd.



SIMON HOUSE, BLAIRGOWRIE DRIVE
RANDBURG 2194



PRIVATE BAG X3033
RANDBURG 2125



TELEPHONES 789-1935-50



TELEX 4-24869

For 68 years, L.H. Marthinusen have been repairing and servicing all types of stationary and rotating electrical plant for South African industry and to-day, boast the largest electrical repair workshop in the world.

BRIGHT SPARKS FOR 68 YEARS

Services offered:

- Rewinding and overhaul of electrical machines — any size AC/DC
- Coils manufactured for armatures and stators
- Insulating materials available for all specifications
- Dynamic Balancing up to 22 metric tons
- Transformers built and repaired
- Ship & Marine repairs (Durban)
- On site repairs
- Service availability 24 hours a day.

LHMarthinusen Ltd

61 Third Street
Industrial Area
P.O. Box 575, Welkom 9460
Telex: 8-8416
Tel: (017) 2-5377/9



KeyPlan 0121

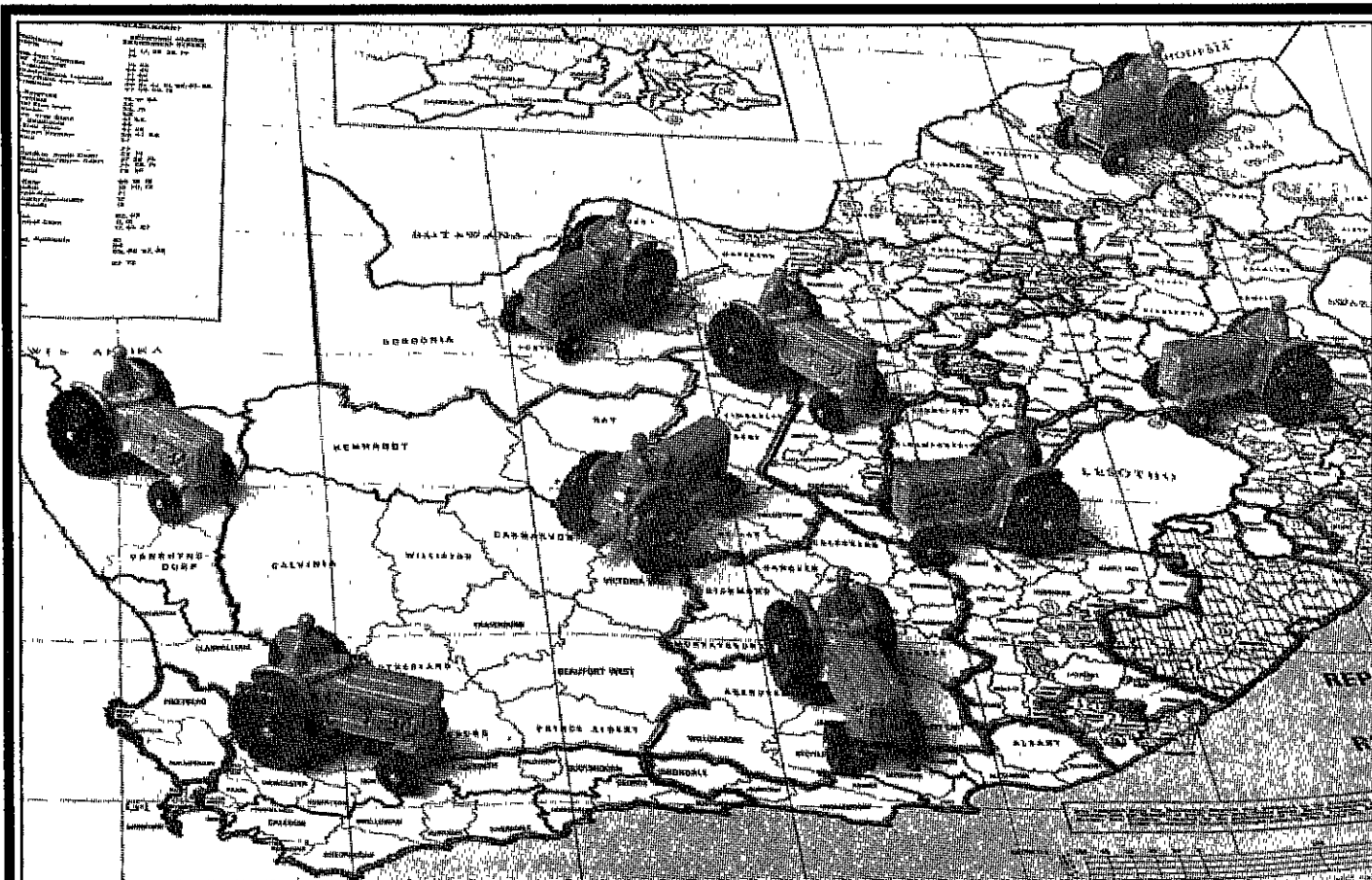

THIS LAND IS LEYLAND.

With two brand new tractors in the range, Leyland now provide South African farmers with exactly the model they need for every purpose.

The new turbo-charged 282 2-wheel drive delivers high power at high altitudes; the new 472 4-wheel drive makes light work of heavy going in soft sand, mud or on steep slopes; while the tried and trusted 245, 262 and 272 2-wheel drive series combine power and economy in just the proportions you want.

Every one of them with Leyland's famous 'driver-proof' all-synchro gearbox.

That's how Leyland is backing the farmers of South Africa today.

Tomorrow a new line-up of Atlantis diesel engined Leyland tractors will be seen across the land.

Proving once again that whatever South Africa needs Leyland can supply.



Leyland
Tractors

ing circular to cane growers.

He said: "You will be aware from the publicity given in recent years by your Experiment Station — of the increasing evidence of pests and diseases in the cane belt — that we are now confronted with a serious threat to the future of the industry. Historically the SA industry has been relatively free of these problems and this situation has made us naturally less concerned about crop hygiene than most other efficient cane sugar industries.

"We are now confronted with the spread of the Eldana borer (see P29) which has devastated crops in parts of Zululand and is now spreading inexorably southwards in sugarcane. Whereas smut was a relatively mild problem in the northern irrigated areas only, it has now become a very serious problem in the eastern Transvaal, Swaziland, Pongola, Mkuzi and Hluhluwe. Of greater concern, is its current spread into the Umfolozi and Empangeni areas, where serious levels of infection are all too common, and its appearance even in the high altitude areas and on the south coast.

"Mosaic has traditionally been a minor problem in a limited part of the southern coastal hinterland, but this debilitating virus disease of sugarcane can now be found extensively throughout the higher altitude parts of the industry. Leaf scald is an extremely damaging bacterial disease which has not yet established itself on a large scale in SA, but it is here and it has the capacity to spread rapidly."

While the effect of the Eldana borer has been stressed as a major destroyer, the combined destructiveness of all the diseases is a greater problem in yield loss.

During the 1978-79 season for example, the combined loss due to the five major diseases was estimated to be about 1.2 Mt of cane, 6.4% of all cane crushed, or the capacity of a large mill. Based on the 1978-79 values of R13/t for cane and R260/t for sugar, growers lost approximately R16m, while the value of sugar lost was some R35m. In 1980 the value of cane lost probably exceeded R25m.

Of the top five — ratoon stunting disease (RSD), smut, mosaic, rust and red rot — the estimated loss caused by RSD is around 80% of the total damage. A survey of 963 fields in 1979 showed that RSD was present in 32% of the fields.

The worst affected areas were Zululand north (53%), Durban-North Coast (52%) and South Coast (43%). The incidence of RSD was lowest in the more recently established cane areas of the Midlands and the presumption at the Experiment Station was that crop hygiene was more assiduously observed there than elsewhere.

Unfortunately in recent years, the control of disease has been looked on by the cane-growers as relatively unimportant. But as accurate surveys in recent years have shown — the high yield loss thanks to

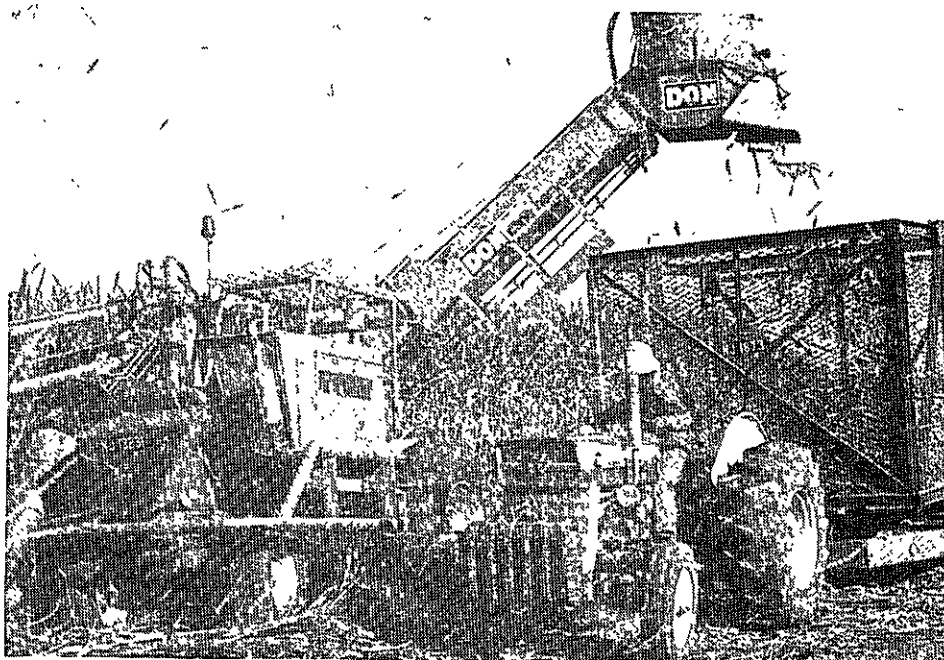

Disease causes a lack of cane to harvest

disease — improving crop hygiene has been emphasised by all the industry's top men. And the diseases can be efficiently prevented by a number of well-proven methods of control which, it is stressed, are simple and cheap to implement.

The worrying situation of more than 20% of samples sent in by growers from intended seedcane fields being infected by RSD, shows one of the major problems. In a survey conducted in central Zululand in 1980, approximately half of the intended seedcane sources examined did not meet the Experiment Station's quality standards.

Most diseases are spread very rapidly by the repeated planting of diseased seedcane. And the incidence of disease like RSD is largely related to the degree of attention given to seedcane production. A simple method of control in this respect is the use of hot-water treatment. The healthy seedcane produced using this treatment should then be planted in fields which have been cleared of infected volunteers. The result of this practice on a number of estates has been the total elimination of RSD. Smut can also be controlled by effective field hygiene. As this is one of the most serious diseases in SA, in that it can cause large percentage loss of yield — and it proves very difficult to control once it becomes severe — it is essential that field control methods should be implemented.

In the Zimbabwe lowveld, smut has been successfully contained for a number of years. All the growers in that area participate in a control scheme that includes the production of clean seedcane, the roguing of smutted stools from fields and the ploughing-out of severely infected fields. A similar approach has been adopted in the Mhlume-Tambankulu area of Swaziland and has also successfully con-

tained smut, despite it being severe in areas to the immediate south and north.

Mosaic is less easily controllable by such methods. And the susceptibility of the varieties of cane most suited to certain areas has led to demands by growers for new, less susceptible varieties. The susceptible varieties, NCo 376 and NCo 293, for example, account for 75% of the crop in the areas considered climatically favourable to mosaic development.

Losses from rust are generally small, but some severe outbreaks have occurred particularly in the cooler areas of the coastal hinterland and the Natal Midlands. Investigation has shown that rust can be effectively controlled by intensive spraying with fungicides, but this has proved to be economically unviable. Rust is prevalent in one particular variety, N55/805. The solution will eventually prove to be found in the use of resistant alternative varieties.

Red rot is unlikely to grow into a widespread major problem although it can severely damage individual fields. Again field control is the most useful deterrent against spreading.

While most of the diseases have proven to be adequately controllable by improving field hygiene, they are still very much on the increase. One of the main reasons for the increased spread of some diseases in the last two to three seasons, was the extensive drought. Almost all cane which has been stressed by lack of moisture is more likely to suffer losses from the major diseases. And the dreadful two year drought in Natal has left a lot of severely damaged cane in its wake, due to lack of moisture and rampaging disease.

The industry's scientists and leaders have strongly recommended that growers make a serious effort to introduce effective control measures before disease runs

A substantial interchange of ideas currently exists between the sugar industries of most producing countries. And international politics have little effect on this relationship.

SA has an international reputation as a sugar producer giving it a number of technical link-ups between local sugar scientists and their foreign counterparts.

The SA Experiment Station sends seed to Japan every two years. These are grown on two of the Japanese islands and suitable varieties are selected. One of these has been the aptly named Nippon-Natal (NIN 2).

Station director Dr Gerald Thompson is one of those who has visited Okinawa at the request of the Japanese.

A similar seed selection system operates for the Chiredzi estate in Zimbabwe, which pays a standard fee for the service.

The Federal Agricultural Research

Station in Tucuman Province in the Argentine has also elected to take SA-bred seed — from male-female crosses. The station also exchanges sugarcane varieties with the Tucuman Provincial Research Station.

An agreement also exists with Malawi on technical production. Both Nchalo and Dwangwa estates are visited regularly and technical advice is supplied on agronomy, disease treatment, cane handling and so on.

The Swazi industry is fully serviced. The SA station supplies the Swazi sugar operation with an extension officer, an agronomist and a disease control officer.

The Colombian industry, too, has an agreement with local experts, who have played a major part in the establishment of an experiment station and research programme there.

Dr Thompson has agreed to spend three weeks each year for five years in

Colombia and says liaison with the South Americans over the past three years has been a profitable experience.

Discussions are likely to take place later this year with the Venezuelians on a possible tie-up on the construction of their experiment station.

The International Society of Sugar Cane Technologists (ISSCT) has a distinct SA bias. At the Manila, Philippines, congress last year, the constitution was revised to allow for a 10-member board of trustees. Dr Thompson and sugar technologist Lokkie du Toit were elected to the board with the only dual membership from a single nation.

Du Toit acted as congress treasurer at the 1970 meeting in Natal, as vice-chairman in Brazil in 1977 and in the Philippines in 1980. He has also been selected as vice-chairman for the 1983 congress in Havana, Cuba.

riot. If they are not contained, the only method left to control their destructive forces would be to withdraw highly susceptible varieties from production. And this would be an unwelcome move, as many of these varieties are the most effective producers in specific areas. New varieties with suitable disease resistance

have been released and others are being selected, but it will be a number of years before the existing problem can be overcome entirely by these means.

To evaluate control measures which will have teeth, the industry is assessing the Australian Pest and Disease Control Boards which have operated there since

1923. These boards have the authority to eradicate crops or order re-planting if an individual grower's problem is threatening the rest of the sugar community in the area.

If the investigation justifies it, the SA Sugar Association is likely to recommend similar measures.

Burning for an answer

Methanol, ethanol or fuel from coal — which is the best alternative? The sugar industry argues for ethanol from sugarcane

The question of alternative fuel (both stationary and automotive) is still the subject of spirited debate.

According to Eric Buchanan, the Cane Growers Association's technical adviser, the factors influencing the debate are politics, economics, production of raw materials, processing, utilisation and the environment.

The major cost factor depends on the choice of raw material, but the overall decision is inter-related to all the factors.

Politically, there are sound reasons for independence from oil producing nations, who may decide on an SA embargo. This is backed up by the rapidly increasing cost of oil products. The last two decades have seen an overall 400% increase in oil prices and the consumption of petrol at the pumps in SA has risen by 13% since 1971. With rapid industrial expansion, the de-

mand for diesel has jumped by 60%.

Then there is the strong influence of the Sasol lobby. The Sasol projects showed great foresight, but in a supposedly free market economy, the economic arguments of other alternative fuel producers, shouldn't be ignored. Why, they ask, should they not also justify a government subsidy to cover initially low profits? To date there have been no positive moves from government in this direction, other than what is generally seen as a token gesture in the form of inadequate rebates.

The economic side is also arguable.

The factory gate prices of Sasol petrol and biomass ethanol, for example, are very close. With the rebate on alcohol fuel additives, ethanol from certain vegetable feedstocks, is now close to economic viability. Production costs are almost recoverable. However, in the case of the major-

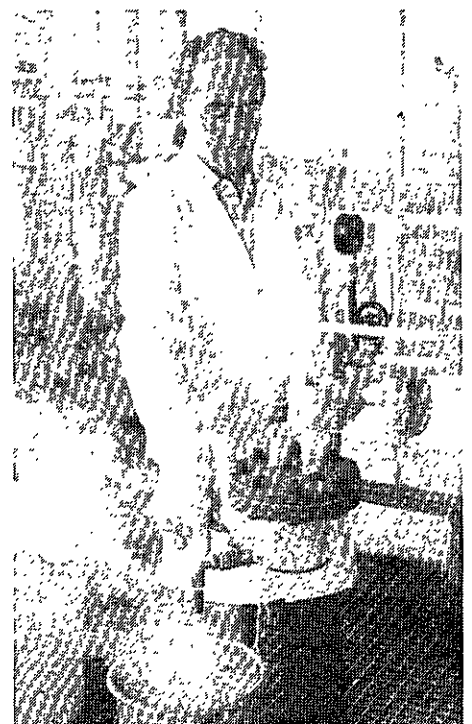

Testing for an alternative



Ruffies

**Durban Overall Co. (Pty) Ltd.
(Pty) Limited**

Ruffies House • 293/7 Umbilo Road • Durban 4001
P.O. Box 2011 • Durban 4000 • ☎ 312751 Telex 6-2293

**MANUFACTURERS OF WORKWEAR
AND PROTECTIVE CLOTHING
FOR INDUSTRY**

**CONTRACTORS TO
THE S.A. SUGAR INDUSTRY**



**Protea
Holdings
Group**



**The Berden
Group**



**Ensure a smooth
flow ~ don't get caught with
your coal stocks down!**

*Your crushing season
is with you –
winter approaches!*

*Did you have
adequate coal stocks to
get you off to a good start?*

*N.A.C. has the coal but the
transport system is likely
to become more congested.*

Our services include:–

- ★ *A fully qualified fuel technologist.*
- ★ *A comprehensively equipped laboratory.*
- ★ *A marketing and distribution division to ensure continuity of supply.*

COAL

**THE ECONOMIC ENERGY
SOURCE FOR THE REST OF
THE 20TH. CENTURY.**

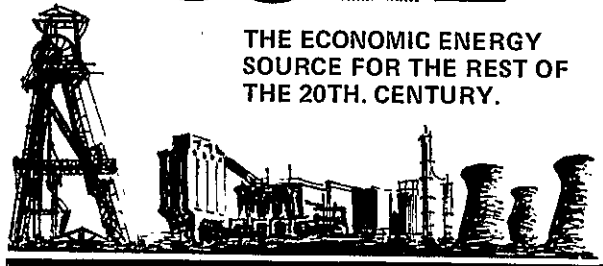

nac

**Natal Associated Collieries
(Pty) Ltd.**

Prudential Assurance Bldg.
269 Smith Street
P.O. Box 952
Durban 4000
Telephone 32-3651
Telex 6-2372
Telegrams "Combustion"

What sets us apart, will set you apart.

At Bates Wells Kennedy we use those words to epitomize our USP – Unique Selling Proposition – philosophy.

It's a disciplined approach to advertising that helps our creative department develop competitive and result-orientated campaigns.



It's the kind of advertising that requires the use of powerfully focussed media, especially if you want to talk to your target audience in a convincing and memorable way.

As a result we recommend Financial Mail to our clients who want to reach the top decision makers.

And it has paid off. In numerous ways. For our clients. For ourselves.

After all, if we set our clients apart, we will set ourselves apart.

Eddie Anderson
Director: Client Services

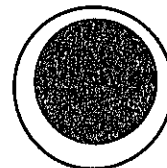

Bates Wells Kennedy
THE USP AGENCY

Trust the experts
Financial Mail

The most effective medium to reach South African decision makers.
Johannesburg 29-2081.
Cape Town 22-1091.
Durban 31-8331.

ity of agricultural feedstocks, additional incentives are required to attract investment.

But the repetition of large plant constructions producing alternative fuel might be silly if the other vital by-products of oil processing are not possible.

Replacing oil, or even coal, as the basic material for automotive fuels is possible, as Natal Cane By-Products' Union Spirit proves.

But a large number of chemical products depend on the oil refineries' by-products, and many are not available from the ethanol and methanol routes.

Bernard Ravnó, director of the Sugar Milling Research Institute, puts it this way: "In SA, crude oil is not the major energy source for the production of electricity. So this is not dependent on imported oil. About 75% of our energy need is met by coal.

"However, the automotive sector is overwhelmingly the preserve of the oil industry and the internal combustion engine.

"The crux of the oil and Sasol lobbies' stance is the ability to supply the overall market spectrum. The oil industry probably regards diesel and petrol as its prime profit generators — despite the effects of price control. It probably makes less profit from its industrial sales of heavy fuels and lubricants, than it does from automotive fuels. Hence, if the alternative fuel producers are permitted to erode this prime market, there may come a time when the oil majors will no longer consider it profitable to operate in this country.

"If alternative alcohol fuels are allowed free rein, this process could speed up. And we should not forget that the oil companies are probably one of our main access routes to crude oil. Therefore, there is a political lobby which wants to keep the oil companies warm.

"If you couple this with the poor economic viability of ethanol produced under present conditions, then government is hardly likely to go too strongly for alternatives.

"But if alternative fuels become economically viable, it would be difficult to deny producers the right to carry on."

Ravnó, Buchanan and others see this as a problem area. There is a fair amount of agreement that government will have to look for a product balance.

But there is still a strong feeling in the sugar industry that ethanol could be a viable replacement, or at least an additive, to gasoline and dieseline. The anti-knock quality alone might justify a 10% blend made from enriched molasses. And ethanol is already a feedstock for a number of chemical products.

NCP and Natal Cane By-Products are heavy users of molasses as feedstock.

On the fuel side, considerable research is being conducted into the miscibility (mixability) of ethanol as an automotive

fuel additive.

The addition of ethanol to gasoline is already well proven in places like Brazil, US and SA (around 20% in petrol and 15% with a stabilising agent in diesel). But dieseline has been the difficult area. There is a need for engine modification to electric spark as opposed to compression ignition, as well as minor tuning adjustments. But there is already proven experi-

ence in adapting engines and using alcohol additives to the basic diesel fuel.

Professor Pottie Meiring of the agricultural engineering department at the University of Natal, Pietermaritzburg, has already explored blend ratios for diesel. He has managed to get an effective 15% additive blend and is currently investigating the possibility of multi-component blends for diesel.



Is Sasol the 'fuel of the future'?

edmis There is more than just Fertiliser in our bags.

A member of the Sentrachem Group of Companies

Fedmis knows that successful farming doesn't depend on fertilizer alone — but that it's the farmer's knowledge and expertise that brings in profits. That is why we put more than just fertilizer in our bags . . . we also offer the following range of services.

Fedmis High Grade Fertilisers.

The use of highly concentrated fertilisers helps the farmer off-set rising transport and handling costs.

The Fedmis product-range includes

LAN 28
Superphosphate
11,3% P
MAP (33)
2:3:2 (30)
3:2:0 (30)
3:2:1 (32)

Fedmis Agricultural Services

Every farm is unique as regards its soil and climate. Fedmis agronomists provide a soil analysis service and are available to advise farmers on the use of the most suitable fertilizers — always with an eye to improving profits.

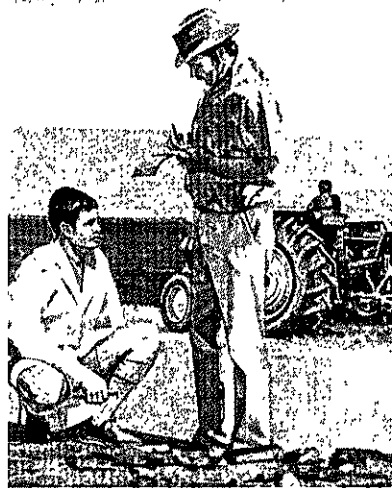

Fedmis Agricultural Guidance

Fedmis agriculturists organise advanced seminars where not only fertilisation problems are dealt with, but all aspects of modern farming methods.



Fedmis Research

Every year Fedmis conducts controlled trials to accurately determine the fertilizer requirements of crops grown on different soils and under different climatic conditions. We take positive steps to pass this information on to the farmer.



Fedmis is Countrywide

There are Fedmis factories in the Transvaal, Orange Free State and Cape Province. Every magisterial district in the country is served by a Fedmis representative. The 'Fedmis man' is only a telephone call away. Contact him — he's there to assist you.

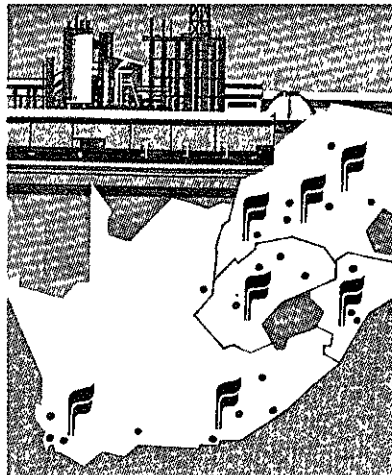

Fedmis Product Development.

Fedmis not only keeps track of worldwide trends regarding manufacturing methods and product ranges, but is also the leader in many fields. Manufacturing methods developed and implemented by Fedmis ensure products that are specially suited to South-African farming conditions.

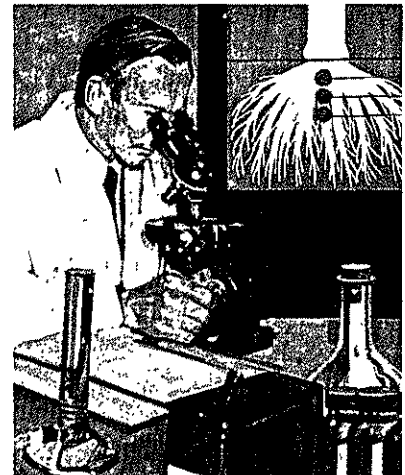

THE TONGAAT GROUP STARTED WITH SUGAR

and has expanded into Foods and Feeds, Textiles, Building Materials, Electrical Engineering and Electronics as well as major investments in Hulett's and other companies.

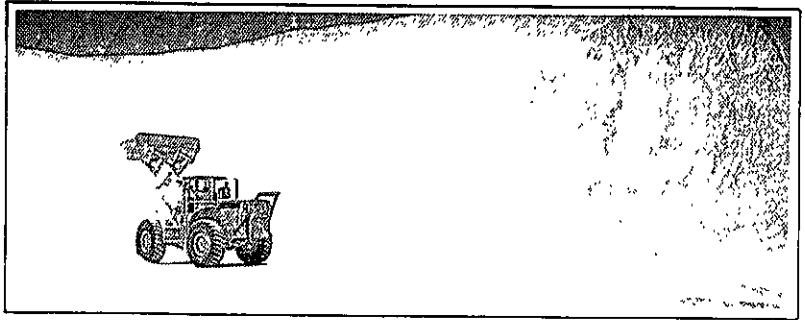

Sugar Division

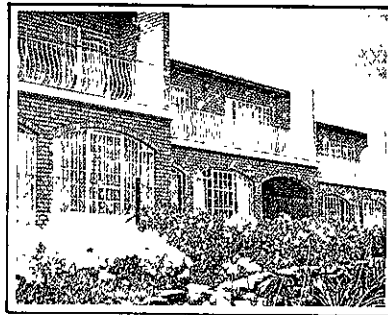

Building Materials Division

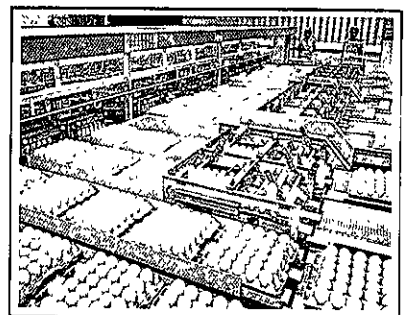

Foods and Feeds Division



Textiles Division

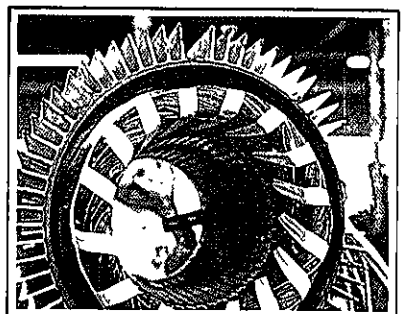

Electrical Engineering and
Electronics Division

AND WE KEEP GROWING



The Tongaat Group Limited



S.A. SUGAR DISTRIBUTORS (PTY.) LTD.

491  DURBAN 4000

 62512

 6-2271

Everybody Loves

Allgold Golden Syrup



In pneumatic conveying these men rely on reliable compressors.

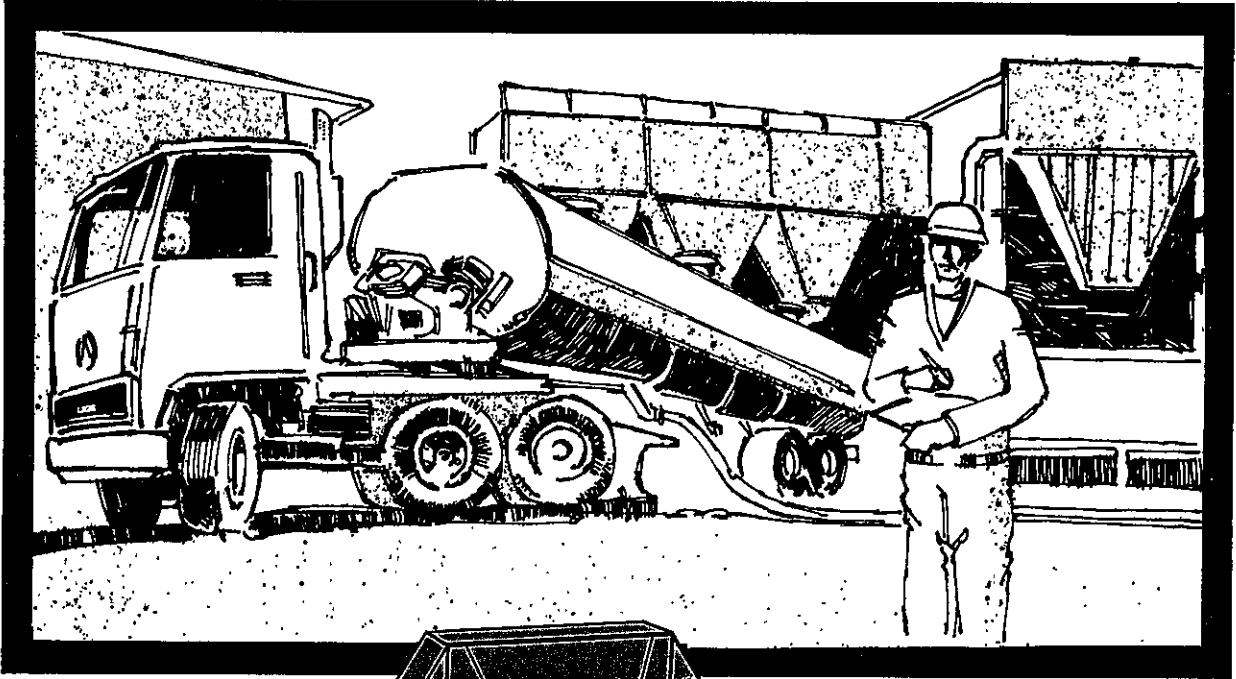

Low pressure pneumatic conveying. The materials handling method of tomorrow. With us in South Africa now. Widespread applications; in sugar handling, cement, food industry, fertilisers. Indeed, wherever a granular product or powder requires handling in bulk, pneumatic conveying has plus factors.

APE Africa is in the forefront of compressors for this new technology. With units such as the VHA/VLA6 series upto the WL 56. Compact, oil free, reliable. On anti-vibration mounts (no foundations needed), and of course reciprocating. The results of 70 years of unbroken dedication to mechanical craft. A range of capacities from 8,5 m³ to 85 m³/min. The APE series of pneumatic conveying compressors. Backed by APE parts and service nationwide. Put your trust in us. We'll reciprocate.

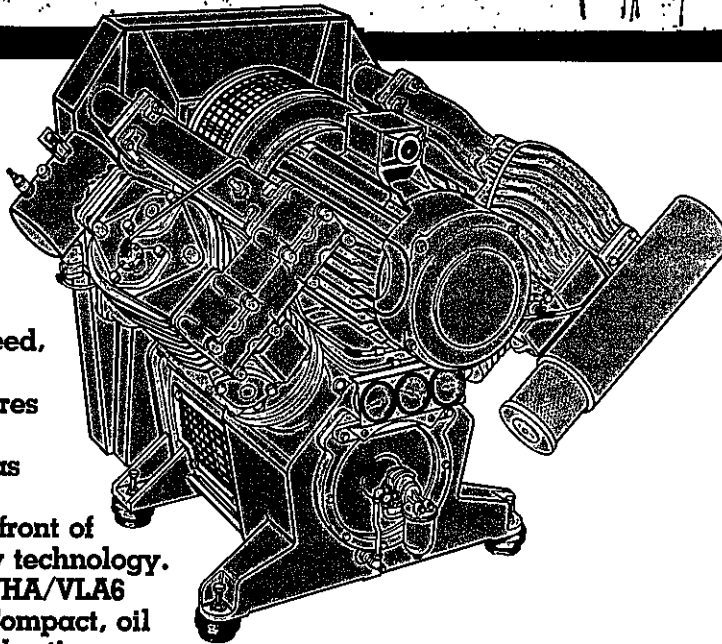

APE Africa (Pty) Ltd

APE. The reliable professionals in compressor systems.

Branches: Wadeville Box 14061 Wadeville 1422. 26 Nagington Road, Wadeville 1401. Tel (011) 34-3511. Telex 8-4779.

Reuven Box 38196 Booyens 2016. 21 Mandy Road, Reuven. Tel (011) 683-5833. Telex 8-0176.

Durban 7 Prospect Road, Umbilo 4001. Tel (031) 45-6088. Telex 56-2095. Cape Town Box 12104 Cape Town 8000. Tel (021) 43-3464. Telex 55-76883.

This investigation was aimed at providing a short-term solution to a fuel crisis. It was felt that SA had neither the manpower nor the capital to modify engines on a large scale in the short-term, but that an alternative additive was a necessity in a crisis situation.

One of the answers in the long term, according to Meiring, is to produce a multi-fuel engine which can utilise a variety of different fuels. And, he adds, work on this is already progressing elsewhere in the world.

His work so far has been done on five-essence fuel. This was set against the various requirements which used a mixture of 0%-60% ethanol. Each increase in ethanol addition required an increased quantity of the other base materials.

The others were a viscosity restorer (castor oil), ethyl acetate to reduce the phase separation of ethanol and diesel (they separate at low temperature and ethyl acetate "binds" them more firmly) and nitrates, to improve the cetane number of the fuel (to optimise the fuel injection to ignition timing in the engine).

This fuel recipe has now been graphed out. But Meiring is careful to stress that the durability of engines using mixed fuel is still not known, nor are other possible detrimental factors.

"Wear" experiments are still being conducted with backing from the Sugar Association and the CSIR.

Work has also been done on blend stabilisers for gasoline (not diesel) by Professor Robin Judd of the chemical engineering department at the University of Natal, Durban. He tested tetrahydrofuran (THF) and furfural as stabilisers. THF proved viable, but the sugar-based product, furfural, led to the destruction of the test engine. Its unsuitable flash-point allowed a detrimental mix with the lubricant.

The heat mechanics division of the CSIR has also done extensive testing of mixed diesel/alcohol fuels on trucks and has achieved a blend level of 10%-15%. Here the stabiliser used was ethyl acetate.

The head of the division, Guido Kerens, set up experiments using ethanol, methanol, sunflower oil and petrol mixed with the diesel.

Also important is the growing international interest in producing multi-fuel engines — diesels with spark ignition.

The technology now exists in companies like Perkins, Daimler-Benz, Cummins and Ford.

Indeed, Ford of Brazil (a major alcohol fuel user) has already produced a batch of multi-fuel vehicles. One of these is also being tested by ethanol producers, Triangle Sugar, in Zimbabwe.

AECI has likewise tested vehicles using a methanol/petrol mix. The company is already producing methanol from coal (the only plant of its type in the world) at Modderfontein. This process uses ICI/Koppers-Totzek technology.

The company is presently testing a fleet of vehicles using a 15% blend and two VW Golfs running on 100% methanol. The results so far have been satisfactory, but there is one disadvantage: methanol is an excellent spark ignition fuel, but, like ethanol, it is still most unsatisfactory for compression ignition.

There has been one major environmental advantage from much of the experimentation so far. Alcohol used as an octane raiser would reduce the lead pollution in the atmosphere by lessening the need for the present octane booster, tetra ethyl lead.

Comparing the two alcohols, ethanol and methanol, raises an interesting environmental question.

The combustion of methanol creates formaldehyde in quantity in exhaust emission. This could be a potential danger to city dwellers and would require an exhaust catalyst system to control the aggressive formaldehyde output.

There is also argument about which raw material would be the best base for alcohol production. Any vegetable material could be a suitable biomass, but a number being promoted have disadvantages.

Cassava, for example, is an efficient raw material. But the problem here is that the disease resistance of this crop has not yet been fully tested.

Apart from sugarcane, all the others (such as sunflower seed, timber, maize and cassava), need a costly transportation operation. The raw material (the fibrous remains of the plants not used for its main task) are presently left in the field. Sugarcane is transported whole to the mills for processing and the transport cost is already covered.

Other processes would also have a major chemical disadvantage. The base material is a starch which would mean added plant cost to produce fermentable sugar. Sugar industry pundits also reason that the proponents of other raw materials would need to develop their technical expertise in a virtually untested field.

But the argument goes on. It revolves less around technology than economics and political support. With the chemical industry poised on the alternative fuel threshold, there is still the need for government to form a definitive policy on controls and incentives for alternative fuel production.

Spirit of union

Natal Cane By-Products, a producer of alcohol fuel since 1917, has diversified into other sugar distillates

The C G Smith subsidiaries, Natal Cane By-Products (NCBP) and Smithchem, have got together through a new chemical formula.

The two companies have been linked by a newly created chemical division, although they retain corporate autonomy.

The division is headed by Ian Mackenzie, MD of Smithchem, and Smith Sugar MD Tony Norton is acting on the board with Charles Matthews, MD of NCBP.

NCBP had been a subsidiary of C G Smith since 1970 (when the group acquired 52% of the shares). But it has had Smith as company secretary and a shareholder from the beginning. Today Smith Sugar (the new controlling company in the group) has a shareholding of more than 80%.

Formed in Merebank, Durban, in 1915, NCBP was registered a year later and started operation in 1917.

The formation of the business was a result of successful tests on cane wax extraction, which led, soon after, to a process for the production of industrial and automotive alcohol fuel.

Cane wax was deleted from the recipe after the war, but the fuel proved viable

until the advent of high-octane petroleum fuel in the early Seventies.

The original fuel, a sugar-based distillation, was the appropriately named Natalite. This was a mixture of 54,5% ethyl alcohol and 45% diethyl ether. In 1927, the fuel proved to be uneconomical and Union Spirit took its place (a blend of alcohol and petrol).

While this was saleable in millions of litres during the mid-Fifties, and even sold 500 000ℓ in 1973, it is now a forgotten fuel source. But it may well revive as a fuel additive.

Today, the factory, which uses molasses as raw material, produces potable and industrial alcohols, ether, vinegar, food yeast, Molex (an animal nutrient made from the dried residue of the factory effluent) and Kalori 3 000 (spraydried molasses).

The net profit history of NCBP has shown exceptionally good growth since the R45 000 of 1969. The 1970 profit had jumped to R270 000 and went from R1 271 000 in 1970 to R2 656 000 in 1980.

The latest project to come on stream is the R2,5m plant at Merebank, producing the co-products sorbitol and mannitol

DORBYL MARINE'S INDUSTRIAL INVOLVEMENT IN THE SOUTH AFRICAN SUGAR INDUSTRY

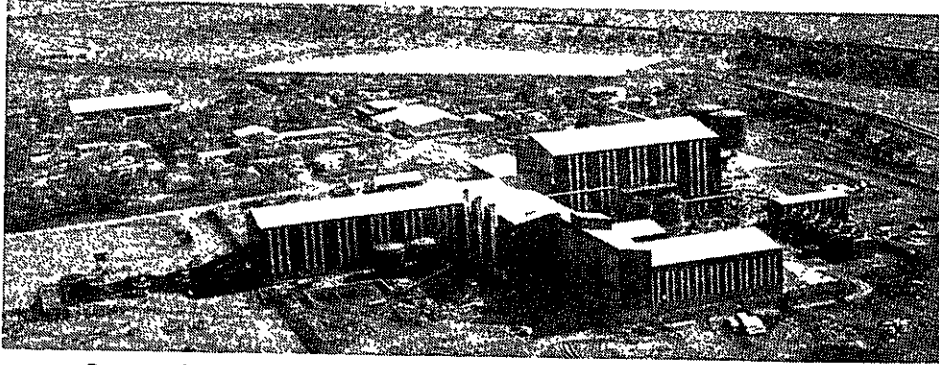

Samunye Sugar Mill, Swaziland — Dorbyl Marine supplied buildings and machinery

Dorbyl Marine have been associated with the South African Sugar Industry for many years and will continue to provide a service with their modern facilities in Durban and Richards Bay. Stress relieving facilities having recently been introduced in our Durban works to provide a complete service to the Sugar Industry.

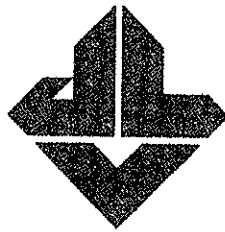

DORBYL MARINE (PTY) LTD

Shipbuilders, Ship Repairers, Construction and Mechanical Engineers

P.O. Box 932, Durban 4000, Republic of South Africa.
Tel. National (031) 251511, International +2731 251511
Telex: 6-2328 S.A.

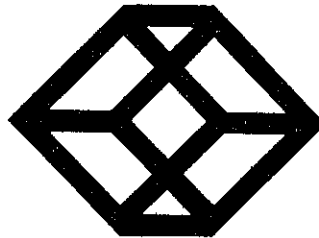

KOHLER

Pacesetters in packaging

Kohler Brothers Limited: Head Office: Ballater House, Melle Street, Braamfontein, Johannesburg. Telephone 39-4349. Corrugated Container Division: Holdain Boxes (Pinetown, Brakpan), Kohler Industries (Cape Town, Port Elizabeth, East London, Paarl). Union-Corrugated Cases (Brakpan). Print and Carton Division: Hayne & Gibson (Pinetown, Johannesburg, East London). Bumleys (Port Elizabeth). Flexible Packaging Division: Genpak (Pinetown, Germiston, Cape Town), Plastics Division: Kohler Plastics (Johannesburg), Kohler Trident (Cape Town, Durban), Blopac (Robertville). Business Forms: Masterform (Johannesburg, Cape Town, Pinetown). Cores, Tubes, Cones and Composites: TPT-Cores and Tubes (Cape Town, Germiston).

A member of the Gencor Group

W waltons
stationery co.

WHERE TO FIND US

DURBAN 372311
EMPANGENI 26971 MOBENI 451921
NEWCASTLE 25821 PINETOWN 712207
PIETERMARITZBURG 28570 SMITH STREET 327151

Also at: Belville Benoni Bloemfontein Braamfontein
Cape Town Clermont East London Epping George Isando
Johannesburg Krugersdorp Nelspruit Paarl Port Elizabeth Pretoria
Stellenbosch Vereeniging Welkom Windhoek

waltons stationery co

FIGHTS INFLATION

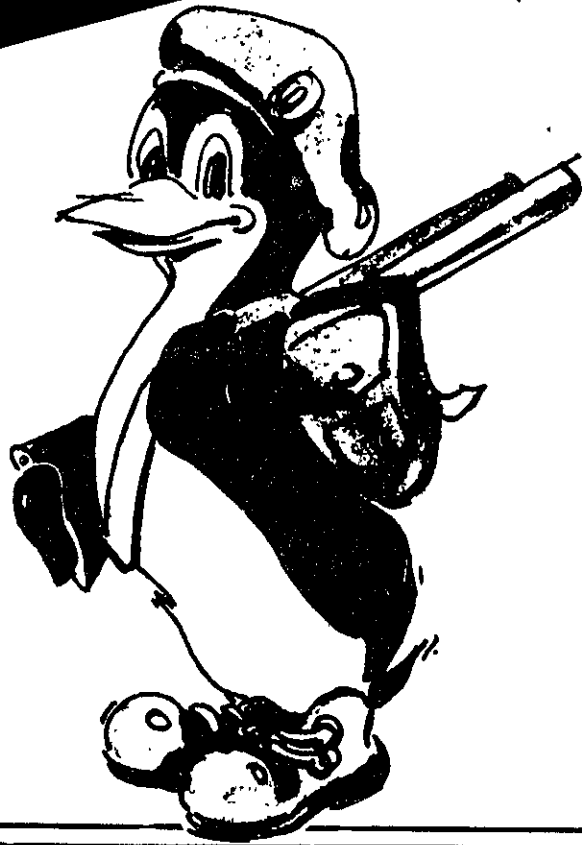

The Natal Cane By-Products Ltd.
SERVING SOUTH AFRICA

P.O. BOX 31003, MEREBANK 4059, NATAL, SOUTH AFRICA
TELEPHONE 42-5341 . TELEX No. 6-4177 S.A.

MANUFACTURERS OF

ALCOHOLS: Potable, Rectified Spirits and Industrial — ETHERS: Anaesthetic, Solvent and Technical Grades — METHYLATED SPIRITS: Absolute, Industrial and Coloured — VINEGAR: Blended and Spirit — SORBITOL AND MANNITOL — FOOD YEAST For human and animal consumption — PAINT DRIERS: Metallic Octoates and Naphthenates.



from sugar.

Sorbitol is used as a stabiliser in cosmetics, toothpaste and tobacco.

When sorbitol is made from sucrose rather than glucose, mannitol is produced as a by-product. This acts as the coating on chewing-gum and as a binding in certain pharmaceutical tablets, such as magnesia.

From the molasses base a fermentation also produces the single cell protein of *Torula* yeast, which is then used in both human foods and animal feeds. The food grade is used to make health products, but the major application is in high-protein soups.

Since molasses is a potential feedstock for ethanol production, the *FM* asked MD Charles Matthews for his feelings on the alternative fuel debate.

"Ethanol from molasses is not easy to justify economically at the moment," he said. "Talking about gasohol, you are looking at sub-strate and energy economics. At present costing, the production of liquid fuel might use too much energy.

"At the current molasses production rates, this is certainly not viable as the base material. In our industry, all the discussion centres on the use of sugarcane passing through a fermentation and distillation procedure to produce ethyl alcohol, otherwise known as ethanol.

"The main costs in this, as I see it, are in producing the necessary carbohydrates and in the energy requirement.

"There may indeed be better base materials. With the development of technol-

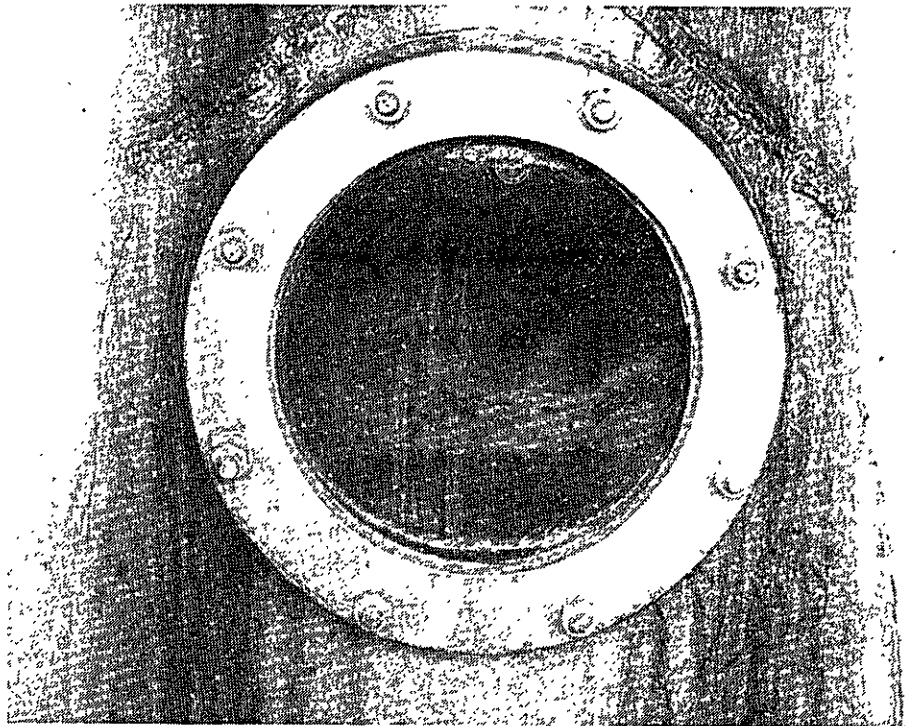

A porthole view of molasses fermentation

ogy worldwide, one of the alternatives may show itself to be the best.

"Our present distilleries can certainly make fuel. But the most economical procedure would require a modified plant.

In fuel manufacture the quality of the end distillation is not as important as the quality needed for beverages, deodorants and toiletries. So the

plant we are now using is really too sophisticated for fuel production.

"At the end of the day, it all boils down to the fact that sooner or later liquid fuel produced from a vegetable base might become viable. But when this will prove to be an economic proposition is difficult to say."

Drought leads to imports

Because of the drought, and rising demand for molasses, SA is now a net importer of a once exportable product

The Pure Cane Molasses Company has been a distributive part of the sugar scene for 57 years.

The original outfit was a subsidiary of United Molasses, a London-based parent.

The present company structure is a result of the takeover in 1965 by Tate & Lyle. T & L were large operators in SA sugar, with their Illovo Sugar organisation, but the sale of that in 1977 left them with Pure Cane and African Products as their only SA subsidiaries. The sale of their majority holding in African Products soon after, reduced their SA interest to Pure Cane.

But T & L have just had a project engineering team from their agricultural division out here to tie-in with the new Smith's Noodsberg mill. They also have a relationship with the Transvaalse

Suikerkorporasie.

Pure Cane are molasses distributors appointed by the local mills to handle their local market, in which they have an 80% share. Tongaat handle their own domestic sales, and Sukramark (Raphaely's) deal for Transvaalse Suikerkorporasie and Union Co-op. The other local operation is Natveld Bulk Exports, who market the small Glendale mill's local sales of molasses.

On the export side, Pure Cane act as the single storage and distribution terminal.

But the current situation of low supply brought about by the drought season, as well as a climbing demand, has resulted in SA having to import, for the first time, to meet local demand.

The figure this year was 11 000 t from Mauritius and 43 600 t from Swaziland,

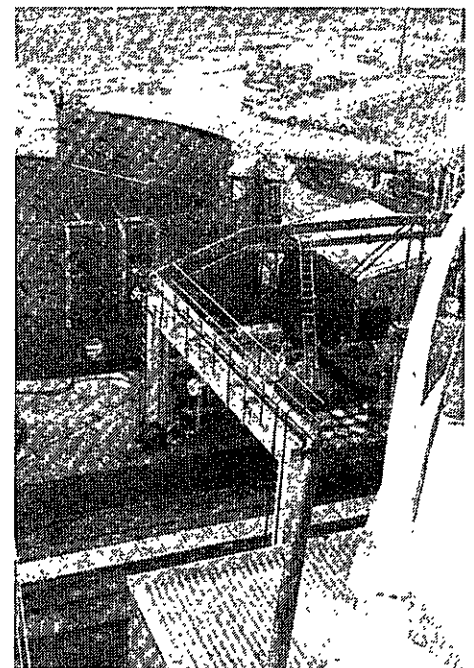

Tanks are now filled with imported molasses



NATIONAL TRADING CO. LTD.

Merchants — Engineers — Manufacturers

**We are growing like the Sugar Industry we service
Did you know that we have SEVEN specialised departments?**

1. ENGINEERING DEPARTMENT

"Chesterton" Packing, Seals, Hydraulics and Industrial Maintenance Products.
"Collins" Pipe Threading Machines.
"Klinger" Jointing and Gaskets.
"Reeds" Pipe Tools, Wrenches, Threaders and Cutters.
"Red Head" Concrete Anchors.
Threaded Bar.
"Ultra Record" Hacksaw Blades.
"Wax" Pipe Bending Machines.

2. PLASTICS DEPARTMENT

PVC Piping, Agricultural, Pressure, Sewer, Soil and Vent.
PVC Fittings and Solvent Cement.

3. PLUMBING DEPARTMENT

"Bopp and Reuther" Water Meters.
Cast Iron Covers and Frames.
Geysers and Water Heaters.
Piping, Galvanised, Black and Steam.
Pipe Fittings, Malleable and W.S.
Sanitaryware and Plumbers Brassware.

4. STEEL DEPARTMENT

"Ampliform" Aluminium Mesh and Floor Grating.
"Cromadek" Colour Coated Sheets.
Egg Grate Flooring.
Expanded Metals.
Handrailing and Stanchions.
Longspan Roofing.
Mild Steel, sections, sheets and plates.
Welded Mesh Reinforcing.
Special Steels and B.M.S. Shafting.

5. TECHNICAL DEPARTMENT

A.P.I. Steel Piping, Seamless and E.R.W.
A.P.I. Buttweld Fittings.
Stud Bar and Bolts B 7 and B 16.

6. VALVE DEPARTMENT

Cocks and Level Gauges.
Pressure Gauges.
Valves, C Iron, C Steel and Bronze
"Amri", "Crosby", "Glencock",
"Hattersley", "Klinger", "Shaw",
"Spirax", "Walworth" and "Vosa".

7. WOODWORKING DEPARTMENT

Woodworking Machines and Accessories
"Centauro", "Fell", "Invincible", "Morbideilli",
"Samco" and "S.C.M."

Natco House, 46 Jeffels Road, Prospecton, PO Box 1757, Durban 4000
Telephone (031) 923340 **Telex 6-4209**

If your truck breaks down here, just hope it's a Mercedes-Benz.

Breaking down in the middle of nowhere can happen to the best of trucks. But it reminds you that, as an operator, the most important man in your life is the Man with the Spanner.

Is he available when and where you need him? Is he competent? This is where the Mercedes-Benz operator has the advantage.

A Mercedes is never far from help because of the country-wide dealer network. There are over 120 strategically placed dealers, staffed with qualified Mercedes-Benz specialists.

So the expertise to fix your truck is at hand. And so are the parts.

Every Mercedes dealer carries a comprehensive range of factory approved parts. And backing him is one of the largest Mercedes-Benz Central Parts Depots outside Germany, carrying over 62 000 different truck items. There is also a "Spares Express" emergency service.

In addition, there's an Exchange Unit Service, with remanufactured Mercedes-Benz factory guaranteed engines, gearboxes, axles and steering units available promptly anywhere. (An engine can cost as little as 35% the price of a new engine, and carries the same warranty).

In short, a Mercedes-Benz truck comes with the back-up services to ensure that downtime is kept to the absolute minimum.



**GET MERCEDES-BENZ
WORKING FOR YOU.**

General Representatives for Daimler-Benz AG in South Africa: UCDD (Pty) Limited, P.O. Box 1717, Pretoria 0001. Over 120 sales, service and spares establishments throughout South Africa.

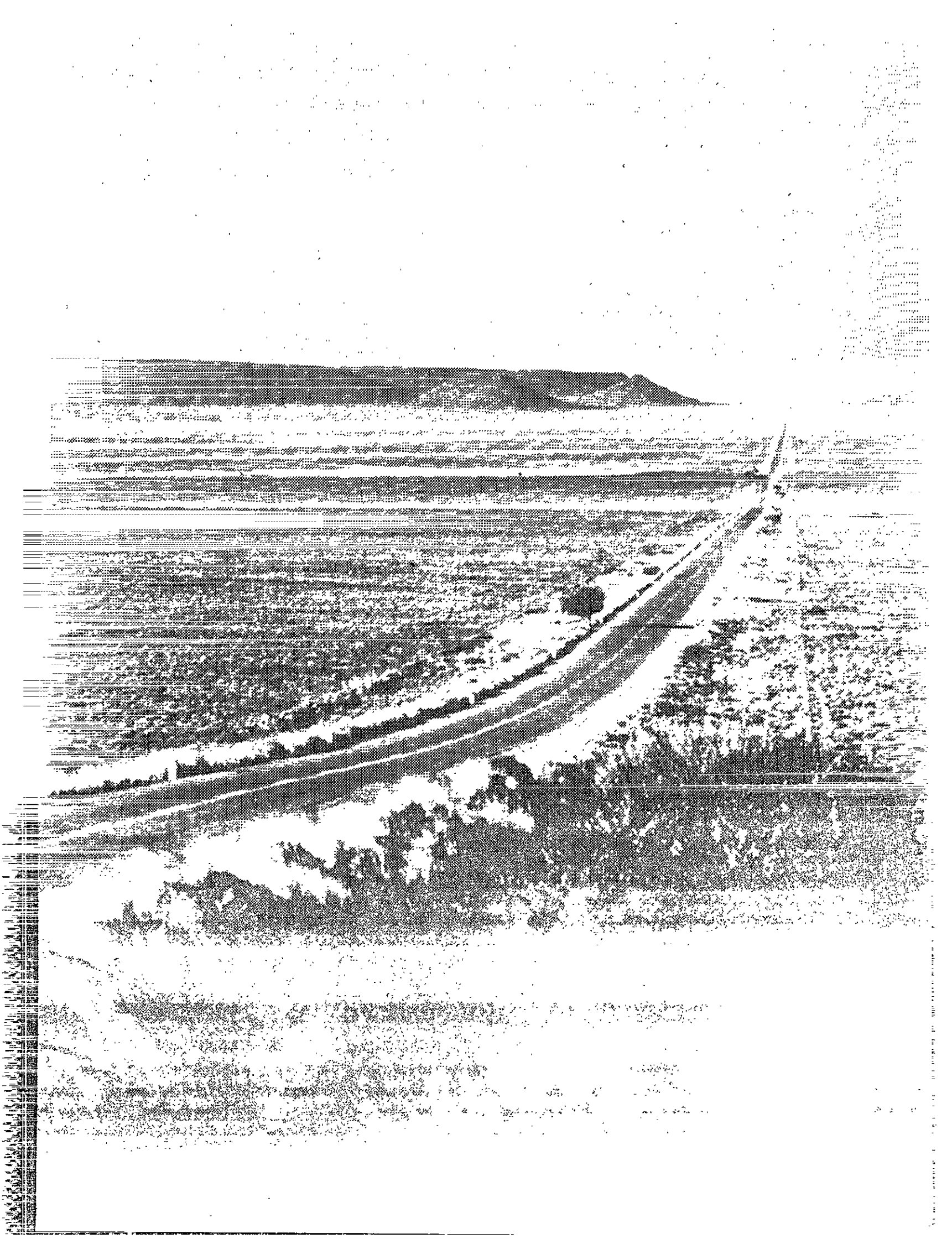

MOLASSES INDUSTRY FIGURES

	77/78	78/79	79/80	*80/81
Industry total production	757 999	676 526	687 910	603 500
Handled by Pure Cane	604 612	518 993	497 675	456 000
DOMESTIC SALES				
Fermentation				
Industry total	271 305	288 709	300 856	298 800
Pure Cane	263 433	274 372	281 228	278 400
Yeast				
Industry total	52 840	55 563	57 457	59 400
Pure Cane	32 063	30 214	31 609	27 000
Agricultural				
Industry total	201 050	210 694	243 636	226 100
Pure Cane	120 610	118 550	130 362	133 300
Other				
Industry total	17 334	18 730	32 940	19 200
Pure Cane	16 638	16 972	30 988	17 300
EXPORTS				
Industry total	215 470	102 830	33 221	—
Pure Cane	171 868	78 885	24 753	—

* Estimate

All figures include the adjustments between the distributors

CHROME ORE OFF-TAKE

	76/76	76/77	77/78	78/79	79/80	*80/81
	1 805	6 731	13 330	15 220	27 481	14 484

* Estimate

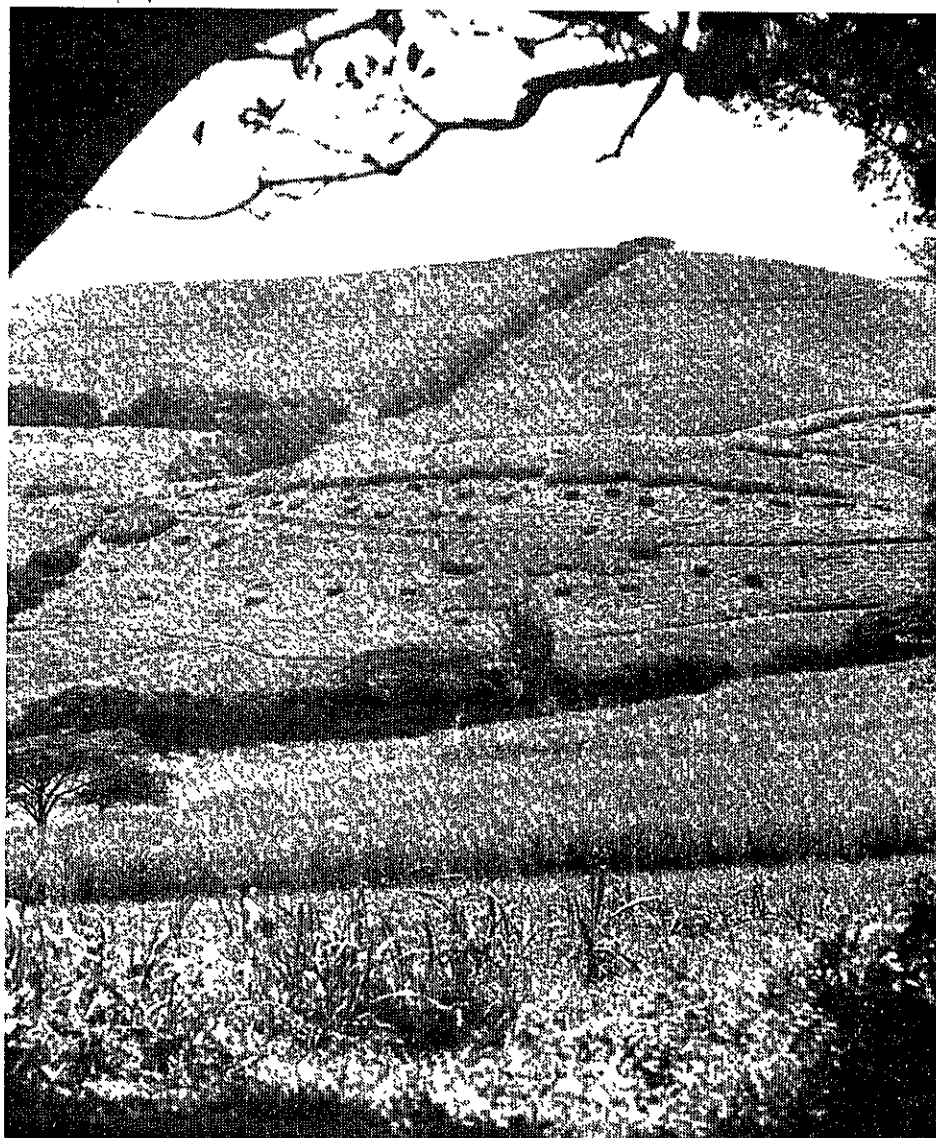

either direct, or from the Swazi export stocks at Maputo, Mozambique. Both those countries' export operations are controlled by Pure Cane. Built in to the Swazi total was a 9 000 t contribution handled by Natveld.

This is a complete turnaround from the exportable tonnage of more than 215 000 t only three seasons ago.

"And," says Pure Cane MD, Trevor Hill, "this situation is likely to continue. The 1981-82 season will also be diminished by drought and the demand for the product is still rising. It is likely that SA is now a permanent net importer."

The local demand at the present is 299 800 t a year for fermentation products: agricultural feeds, 226 100 t a year (and rising fast); yeast products, 59 400 t (steady rise), and other users sitting at 19 200 t.

The interesting fact about the "others" was the burgeoning increase in the use of molasses in the chrome industry for briquetting previously unusable fines. This industry's waste (unlike solid ore) was not particularly marketable. However, for a three year period, world demand for chrome allowed SA producers to sell their lower quality dump waste in the briquetted form.

But the rundown in the world steel and chrome markets has seen the demand for briquettes falling off, and a promising industrial molasses market has again diminished, as can be seen from the chrome ore off-take chart. ("Other industry total"). But Hill is optimistic that this market will lift-off in about a year's time, when the Western world economies revive.

As with sugar, a similar supply set-up in the industry exists. Demand in this country has to be satisfied before exports can be undertaken — despite a disparity which places the SA price at an unrealistically low level against the open world price.

Ten years ago, the SA price was R3,84/t to the fermentation industry. In December 1979, it had reached R18,50/t, and by January 1 1980, it was fixed at R28,50/t. In January this year, the price rose to R37,50/t.

These are high percentage rises, which in no way match Western world norms.

The USA price at the end of April had dropped to a low-point of \$98-\$113 from the previous level of \$118-\$120 a short ton. The European asking rate was \$140-\$150 a metric ton.

With this year's off-season imports, a number of users are seeing the anomaly in the prices they face.

Pure Cane's Hill is sure that SA's situation as a net importer is bound to continue.

Demand is rising in the various sectors, but supply is limited by both drought and the potential re-introduction of the ISA's restrictions on production of sugar expected in 1982.

LEADERSHIP IN STEEL SERVICES . . .

WOLHUTER
STEEL
SERVICE

The Woluter Steel Group not only merchants steel, but processes it in the following forms too:

- Tube manufacture at **Woltube**
- Profiling guillotining at **Wolcut**
- Flange manufacture at **Wolcut**

Add to this the new developments in Wolhuter, viz:

- Modern blanking line at **Wolhuter Natal**
- Integrated beam line at **Wolhuter Wadeville**
- Automatic flanging plant at **Woltube**

Our investments in steel processing underline our commitment to servicing the needs of the Steel Industry in South Africa.

Can we be of service to you?

Contact us at:

woltube

- | | | |
|--|--|--|
| • Wadeville (011) 34-9200 (14 lines)
PO Box 14100, Wadeville 1422 | • Pretoria (012) 79-5835
PO Box 19103, Pretoria West 0117 | • Klerksdorp (018) 27575/6
PO Box 1677, Klerksdorp 2570 |
| • Wolcut (011) 34-3546
PO Box 9155, Elsburg 1407 | • Woltube (011) 825-1505
PO Box 9222, Elsburg 1407 | • International (011) 34-9200 (14 lines)
PO Box 14100, Wadeville 1422 |
| • Natal (031) 92-2303
PO Box 32184, Mobeni 4060 | • Welkom (017) 7-1358
PO Box 2807, Welkom 9460 | |

Wolhuter and S.A.S.A. go hand in hand

BP's worldwide experience is only a phone call away.



For many years BP has been closely associated with the South African Sugar Association.

We are major suppliers to them of petroleum products which include a wide range of lubricants.

Understandably, to meet their scale of demands requires considerable technical and managerial liaison. We are thus greatly helped by our worldwide research programmes and on-going development.

It's this sort of expertise which enables us to service not only the South African Sugar Association, but a large variety of major international business and industrial concerns. You too can benefit from our service and technical knowledge simply by contacting BP.

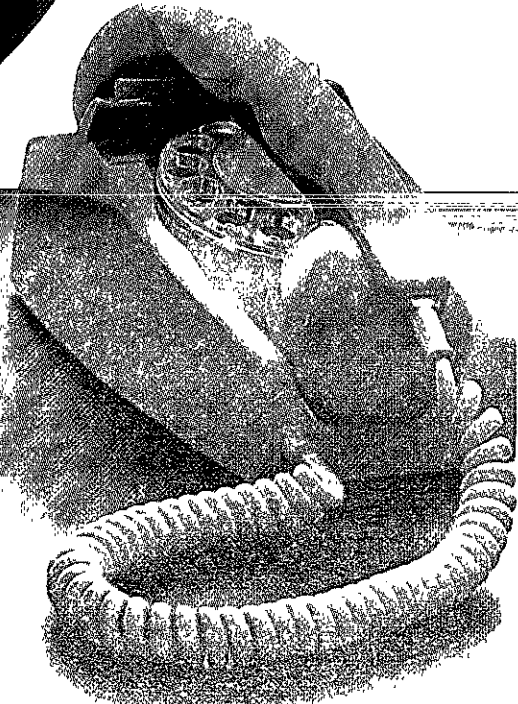

We like to keep you moving.



Sugar by the gallon

The soft drinks industry is the country's largest industrial user of sugar

Growing demand for soft drinks over the past two years has pushed up the industry's sugar usage fast. In 1980 demand was 94 736 t for the year. That cost the industry — sugar is one of the main ingredients of soft drinks — more than R32m at the present price of R339/t.

Annual usage in 1978 was 67 975 t. This jumped 12,5% to 76 487 t in 1979, and 23,86% to the 1980 total. The expected rise in 1981 is 15%, which gives an estimated total of around 109 000 t.

These annual usage figures do not correlate with the seasonal demand figures issued by the SA Sugar Association. But the answer is simply that there has been extra stockpiling in low usage years, and an annual average purchase of 76 687 t for the past five years.

This year, stockpiling is likely to be even more significant. The 10% increase in the price of sugar, which had been expected, along with the recent 14% rise in all railway charges, will contribute to this.

Another reason for stockpiling of both the raw materials and the end product is attributed to the shortage of CO₂. This is already the case, and the maintenance close-down of the AECI CO₂ plant will add to the problem.

The SA Federation of Soft Drink Manufacturers has already stressed that members will have to store extra stocks of products to meet demand during a period when their production capacity will be restricted by shortage of the gas.

The industry's off-take of sugar (as opposed to usage), from May 1 1980 to the end of February 1981, is already well up on the annual average at 86 352 t.

The price rise of sugar, from R123/t in 1972 to the 1981 price of R373/t has been a growing worry to this price controlled industry.

A more than 300% price increase of one of the principal raw material needs has been met with only a 50% rise in the price of soft drinks over the same period.

ANNUAL OFFTAKE BY SOFT DRINK INDUSTRY

Year	Tons
1975/76	76 603
1976/77	76 287
1977/78	71 566
1978/79	79 758
1979/80	79 243
1980/81	100 649

SA Sugar Assoc figures

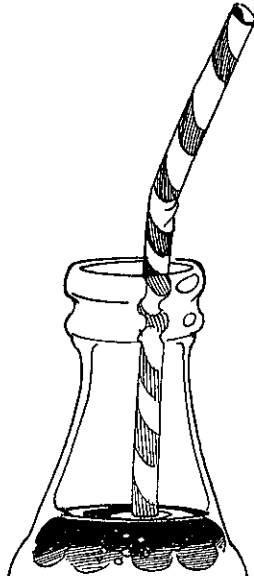

The last increase in the soft drink price was on September 15, 1980. This delay from the May sugar price rise led to the industry having to absorb a drop in profits

for the three months. The price rise granted was only allowed against the sugar increase.

With a sugar price jump this year of possibly 10%, the industry is looking at an increase in sugar cost of about R3,2m with apprehension.

The whole question of sugar price rises has been a point of discussion between the industry and the Sugar Association for some time.

Senior industry executives have (as have leaders of other large industrial sugar users) suggested having a lower industrial price rating. This, some say, should be covered by increasing the ordinary domestic price. But so far, the government has kept a very strict rein on the price to the public, and it is considered unlikely to accept this reasoning.

The main discussion at the moment revolves around the possibility of the industry gaining from the bulk sugar scheme, due to start for Reef customers at the end of June this year.

Hennie Viljoen, vice-president of the Federation, says that the negotiations initiated so far "have led to a hopefully better deal on sugar costs.

"We would naturally have to build our own bulk plant installations, but there will be an ultimate saving in wastage, con-

SALES TO INDUSTRY



WHITE & BROWN SUGAR SALES

	1980/81 Tons
Bakers	14 908
Canners	50 524
Sweets	68 247
Condenseries	17 664
Mineral waters	100 649
Squashes/cordials	20 182
Food	37 104
Ice cream/dairy products	8 163
Brewing/liquor	10 415
Non-food	5 648
Industry, total	333 504
Total domestic sales	832 245

WHOLESALE PRICE PER TON OF REFINED SUGAR

	R
Feb. 18, 1972	123
Nov. 1, 1974	108
Sep. 1, 1976	126
Nov. 12, 1976	186
Dec. 30, 1977	246
June 30, 1978	266
Feb. 28, 1979	291
Aug. 31, 1979	311
May 2, 1980	339
Apr. 2, 1981	373

Figures supplied by SA Federation of Soft Drink Manufacturers

How? With our new corrosion resisting Supersteel 3CR12.

Where does Supersteel 3CR12 fit in?

In the huge gap between rust-prone carbon steels and conventional stainless steels.

Especially as a replacement for coated carbon steels in industry.

Supersteel 3CR12 is maintenance free. It gives a new meaning to long life. An added dimension to durability. In heavy-duty conditions it can outlive carbon steel equipment in excess of ten times.

When you consider that about half of the world's current annual carbon steel production is solely for the

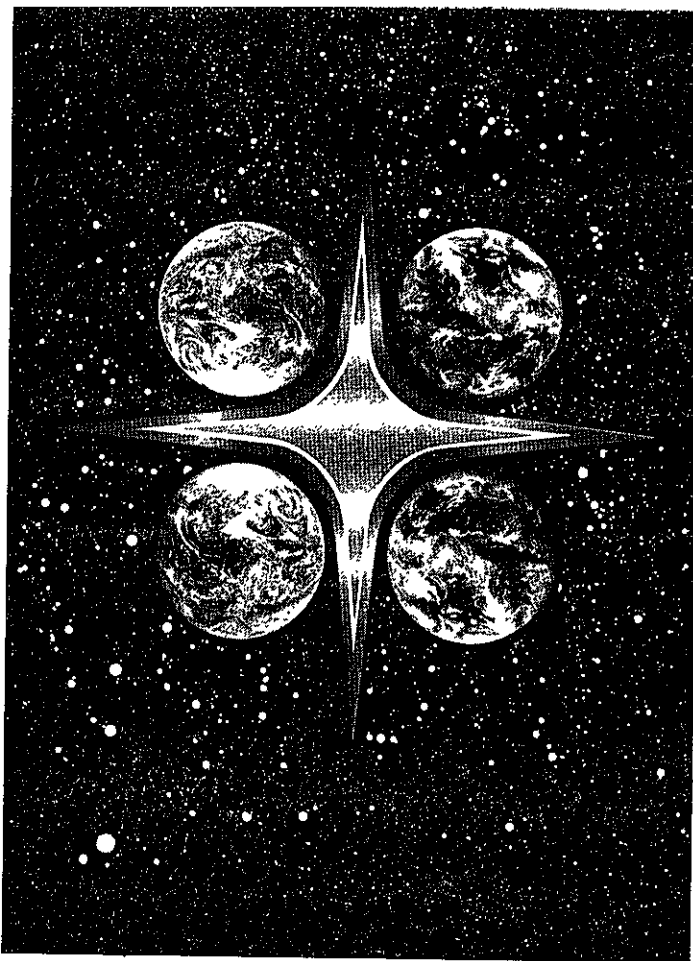

replacement of rusted carbon steel items, it is clear that Supersteel 3CR12 has a vital energy and labour saving role to play.

We think the world will take to Supersteel 3CR12 like a duck takes to water.

If it does, the world will change for the better.

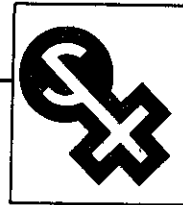

Southern Cross Steel

Southern Cross Supersteel 3CR12 is currently being used in such industries as Gold Mining; Coal Mining; Pulp and Paper; Marine; Brick; Sugar; Agricultural. For detailed information and data on the use of Supersteel 3CR12 for your specific requirements, please write to the Market Development Division, Southern Cross Steel, PO Box 781815, Sandton, 2146.

We think Southern Cross Steel can change the world.

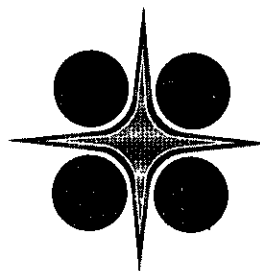

**It's
Southern Cross
Or rust**

Southern Cross Steel is a member of the Barlows Group, and distributes to 26 outlets in South Africa and to over 34 countries worldwide

Bimate

**NEW! LONG-LASTING
BROAD SPECTRUM
WEED CONTROL
FOR USE IN
BOTH RATOON
AND PLANT CANE**



ELANCO

A division of Eli Lilly (S.A.)
(Pty.) Limited, P.O. Box 98, Isando 1600,
Transvaal, Telephone 36-7254

Distribution by Agricura

DIMENSIONS 7066

tamination, pilferage and the like."

Another area of debate is the present railage charge for users on the Reef. At the moment all sugar used is charged for at a rating ex Rossburgh (Durban).

But, says Viljoen, this is considered unfair for the bottlers in places like Nelspruit, who get their supply from the nearby Eastern Transvaal mill at Malelane.

The Federation is hoping for some dis-

pensation for this from the Sugar Association.

If the price reaches unacceptable levels, an alternative (like high fructose maize syrup) may be needed.

Sugar sweet

Sweet-eaters are guzzling more than R22m worth of sugar each year

The R300m-a-year confectionery industry uses more than 60 000 t of sugar to produce its annual quota of sweets and chocolates.

The vast number of confections on the market have one thing in common — they use white and brown sugar to produce that tongue-tingling taste.

Indeed, most sweets are more sugar



SWEET INDUSTRY'S ANNUAL USAGE

Year	Tons
1976	70 832
1977	70 380
1978	60 446
1979	60 315
1980	66 274

than anything else — 40%-60% in most cases. The industry uses mainly white refined sugar (98%), with a small 2% brown sugar off-take.

As in other sugar-using industries, it is not possible to relate the annual consumption to seasonal purchase figures from the SA Sugar Association because annual demand varies through stockpiling in low-usage years. And the industry figures are quoted in calendar years, while the association's sales figures are based on a May 1 to April 30 season. Nonetheless, the industry fed the sweet-loving public 328 244 t of sugar in the five years from 1976 to end-1980.

The 117 871 t of confections produced in 1979 gives an indication of the industry's size.

Sweetmakers show a healthy rise in sales and profits (Cadbury Schweppes, for example, reported a 178% rise in pre-tax profits for the first half of its 1980 financial year). But there are still pessimists in the trade.

Like most other high ratio sugar users, the confectionery business is concerned about the rising cost of sugar. Manufacturers have little room to quibble about the increases in this price-controlled base material. They don't suffer from similar restrictions, and can, and do, adjust prices to cover all increases in cost. But there is still the danger of damaging market demand with price increases.

No alternative sweetener is viable at the moment. Unlike soft-drink makers, who can use high fructose corn syrup, or ethanol producers who can switch from molasses to maize, the sweet industry is tied to sugar.

A more promising development for cost-conscious confectioners comes in the shape of possible bulk deliveries of sugar.

Present storage methods involve bagged sugar stacked on pallets. This suffers from the usual wastage factors like pilferage and contamination. Bulk delivery and storage would reduce wastage and improve storage hygiene. But industry experts also see economic problems in setting up factory bulk storage facilities.

Like bakers, sweetmakers have large numbers of mixing points for each of their different products, which have to be fed from sugar stocks. This leads to the need for a relatively complex system of feedlines and weigh points. So the high cost of in-plant equipment to cope with bulk storage might very well offset the other economies.

But despite these problems, no one in the industry is prepared to say that returns from sweets will not get sweeter in the future.

The fruit canners

The fruit canning industry is basically export-orientated — and it's facing stiff competition

The SA fruit canning industry exports 90% of its annual production of fruits. This is the main section of production, but canners also export some jam and canned fruit juices.

Between 10m-12m cases of fruit (of the more than 13m produced annually) are sent abroad each year. That's R140m worth of foreign exchange. Add to that,

the export total of 200 000 cases of jam and 500 000 cases of canned fruit juice, the annual total approaches R150m.

The bulk of these exports (about 85%) go to the UK and Europe.

But, according to Fruit Canners Association chairman Geoff Glendining, this once healthy export operation is now facing critical price competition.

There are a number of reasons for this, but the prime two are the heavy European Economic Community (EEC) tariffs being faced by SA exporters, and an increasing hardening of the rand.

The EEC tariff on canned fruit is 22%, and that on jam a very high 30%. There is an additional duty on the sugar content of canned fruits of 2% and a duty on jams of

NOW NBS SHARES PAY MORE THAN EVER BEFORE.

NBS Paid-Up Shares now pay 10% per annum!

Yes, with NBS Paid-Up Shares you get **10%** per annum, the highest interest rate currently available on this type of investment. And, depending on your income, you also

get **up to 100% of your dividends absolutely tax free.**

NBS 10% Paid-Up Shares help you fight inflation and

quickly build your capital. Buy them anytime, as many as you like, in units as little as R10,00. There's no limit, and no maximum balance either.

Can you think of a better all round investment right now?

Here's another NBS winner!

NBS Fixed Period Shares now pay you a **guaranteed dividend of 11.5%** per annum for 5 years!

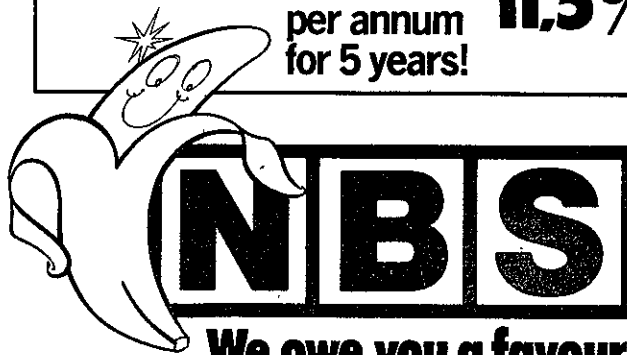

We owe you a favour.

Bates Wells Kennedy • 8327/2



The
Pump Division
of

SANDOCK-AUSTRAL Ltd

LOCAL MANUFACTURERS OF THE WORLD RENOWNED



NASH[®]
VACUUM PUMPS

and



ALLIS-CHALMERS
CENTRIFUGAL PUMPS

thank the Sugar Industry for their continued support
and wish them a bright and prosperous future

**WE
COVER NATAL**



**Blaikie-
Johnstone**

**Building
Material Merchants**

Head Office:
 Mobeni Tel 031-422011
 Durban Tel 031-371428
 Dundee Tel 0341-21191
 Empangeni Tel 0351-25311
 Estcourt Tel 03631-3137
 Ladysmith Tel 0361-2171/2/3
 Margate Tel 0393-22506
 Mtubatuba Tel 03552-22/28
 Newcastle Tel 0343-27151
 Pietermaritzburg Tel 0331-29541
 Pinetown Tel 031-724351
 Port Shepstone Tel 0391-20015
 Vryheid Tel 0381-3716



about R2 a case.

With the growing number of countries around the Mediterranean which are now becoming fruit canners, some of whom are members of the EEC or have agreements with it, there is a problem for SA manufacturers in competing on price. This, despite SA quality being considered among the best in the world.

Added to that is the difficulty of the growing strength of the rand. This has seriously overpriced the SA product, which has meant the canners are taking, in practice, lower prices to effect sales and stay in business in the export markets.

This is aggravated by the fast softening currencies of major competitors. The Italian lire, for example, has depreciated by 41% against the pound sterling since 1979, and the Italians are big in the fruit canning game.

Sugar is an important raw material in the industry. The vast majority of canned fruit is packed in a sugar syrup. Jams too, are large users of sugar, with a content rate of between 60%-65%. This is used mainly for sweetening, but it also has a preserving effect on the final product.

Jam must, for reasons of composition, continue to hold much the same percentage. But there has been some consumer resistance to the sweetness of canned fruit. The amount of sugar in the syrup has been slightly reduced in recent years.

The tonnage of sugar used by the industry has dropped since 1976, but this is related to the jam production in 1976 and 1977. Both those years saw a production rate of 2m cases, with a drop to 1m cases in 1978 and 1979 — due to an oversupply situation. Last year's production levelled off to 1,4m cases.

ANNUAL OFF TAKE BY FRUIT CANNERS

1980	57 000 t
1979	46 000 t
1978	47 000 t
1977	62 000 t
1976	61 000 t

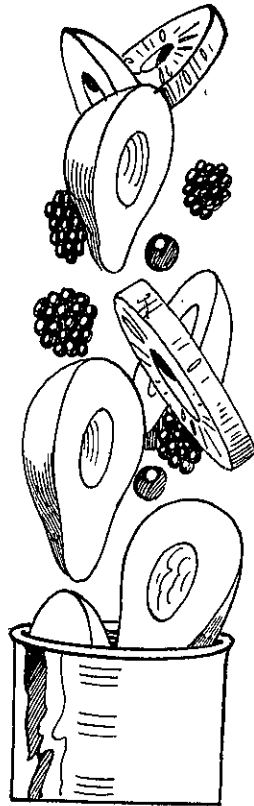

It is probably fair to average the industry's sugar usage at about 50 000 t a year.

While it's a necessary ingredient, the industry has been disturbed by the fast rising price of sugar. Since 1974, when cost per ton was R108, it has jumped 245% to the 1981 price of R373/t (for Durban) for refined product. In annual terms this escalation has been more than double the rate of inflation.

The price rise has had detrimental effects on sales of jams on local markets, and has also had some effect on sales of canned fruit.

There is no argument by the canners that the price rise has not been required by the sugar industry, but the result has not made it any easier for canners to sell their product in a highly competitive market.

Glendinning stresses that, whilst the industry has been doing all it can to restrain rising costs, and become as efficient and productive as possible, the two main inhibiting factors — namely, the currency problem and the high import duties in the UK and Europe — are outside its control. These affect it more than most, because of its high export dependency.

The use of a bulk sugar system, similar to the new one for the Reef, has been examined, but this is unlikely to be usable for a number of years.

The SA Sugar Association's local market manager, Frans Oosthuizen, feels that the system may be desirable to both parties, but is economically not viable due to a number of technical difficulties.

As Glendinning said: "It is not a proposition at the moment, but that doesn't mean it's a completely dead issue. It could be a good means of keeping down costs if it could be instituted economically."

Baking sweet bread

Taking a look at sugar's important role in the baking industry

The baking industry uses sugar in nearly all its products. Notable exceptions are the purely flour based products, such as pie crust and puff pastry.

Sponge cake tops the list with the highest sugar content. Following that is the approximately 25% sugar content of Swiss rolls and normal pound cake. At the 15% level is Boston bread, closely followed by Marie and lemon cream biscuits in the 10%-15% range.

At the bottom of the list is ordinary white bread, with a low sugar content of around 1%.

In the UK, there is a move away from using sugar as an additional fermentable product in the making of bread. Instead,

bread bakers depend on the enzymes of flour which convert starch into sugar during fermentation.

The combined effects of fermentation and baking give bread its "crumb texture" and "loaf volume."

ANNUAL SUGAR OFF TAKE BY BAKING INDUSTRY

	White	Brown	Total
	Tons		
1975/76	13 001	4 196	17 197
1976/77	13 451	2 886	16 137
1977/78	12 602	2 744	15 346
1978/79	11 200	2 190	13 390
1979/80	11 313	2 233	13 546
1980/81	12 213	2 695	14 908

Jack Piek, technical manager of Bakers, explains this in his baker's jargon.

An interesting offshoot of the bread-baking procedure is a highly usable waste. Essential ingredients of bread are flour, fat, yeast and salt water, to which it is customary to add about 1% sugar. As a result of fermentation, CO₂ and alcohol are formed. The alcohol, however, is baked off and lost to the atmosphere. This amount is an appreciable 0,25:ℓ for each sack of flour used. Big bakeries, therefore, lose tons of alcohol each week. To date, no bakery has been successful in recovering this valuable by-product.

It is important to distinguish between biscuits and crackers. Crackers are usually made from fermented doughs — that is, yeast is used. Biscuits, on the other hand, depend largely on sugar and fat for their eating properties. The crunchiness of the biscuit is usually defined as "shortness"

in layman's terms.

Sugar plays four other important roles in biscuit manufacture. It adds to the flavour, colour and appearance (sugar dusting of Boudoir and Nice biscuits, for example) and coarse sugar promotes the "flow" — a term used to define the spread of the biscuit during baking.

The dissolution rate is an important factor in the final product. Apart from biscuits like ginger nuts and rice, where flow is required, biscuit doughs require the sugar to be entirely dissolved.

This is achieved by balancing the type of sugar used with the mixing time. Number one refined sugar is the coarsest type used. Castor sugar is less coarse and icing sugar is the finest grade.

In biscuits with a short mixing time, castor sugar is used to achieve full dissolution. With long mixing times, as in the case of Marie biscuits, refined sugar can be used and still dissolve during mixing. This is equally applicable to other "semi-sweet" types of biscuits, for example lemon creams.

In flour confectionery, sugar again plays a major role to give cakes their various textures and flavours. The cream fillings also have a high sugar content, but here icing sugar is used so that the sugar blends with the fat to give a smooth cream.

As in other sugar-using industries, the

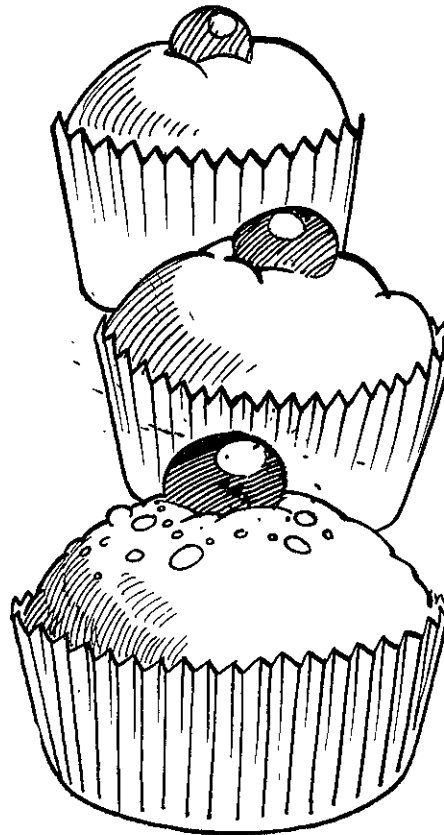

cost of this raw material is of continual concern to the baking industry. At the moment, there is no sign of any relief in the sugar price. But the baking industry is also keenly reviewing the prospects of a less costly storage and transport system with the arrival of the Sugar Association's bulk-delivery installation on the Reef.

It could supply part of the answer to the cost problem, but there are certain disadvantages to the in-factory installations it will require.

As in the sweet industry, bakers have a large number of mixing points. The cost of the extra plant to feed them is a possible drawback to its being viable.

The various mixing points need, not only pipe delivery to each, but an accurate system of weighing off the mixing quantity at each point. The cost has not yet been accurately calculated. But there is the feeling that it could double the cost of the standard silo-pipeline-syrup vat installation used by soft-drink manufacturers and the like.

And tied-in with the separate needs for No 1 refined sugar, castor sugar and icing sugar, there is a high usage of other sweetening agents. The baking industry also employs invert sugar, malt and 70% sugar-content golden syrup.

This variety of sugar products could invalidate the cost of storage of only one on a bulk-supply system.

Suppliers to the Sugar Industry

FOR A QUARTER OF A CENTURY



Specialists in the supply of:

Prepacked farm rations,
bulk farm rations,
Jabula Food Products,
Epol Feeds,
Shell Gas & paraffin,
maize & wheat products,
dried beans, rice & fresh produce.

NARIANSINGH & SONS

NARIANSINGH CENTRE
81 ROOD STREET
PO BOX 90
STANGER 4450

PHONE
(0324)-21191

What Total Project Capability means for South African Industry

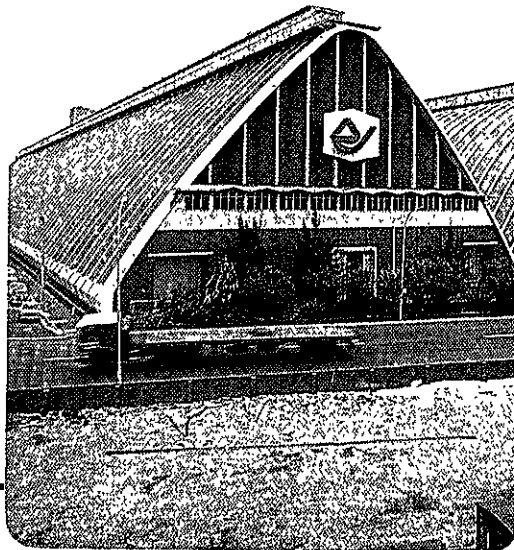

Feasibility Studies

Process Design – and Consultation

Engineering & Design Services

- Civil and Structural
- Mechanical and Piping
- Electrical & Instrumentation
- Materials Handling Systems
- Industrial Engineering
- Quality Assurance

Project Management Services

- Planning and Scheduling
- Estimating & Cost Control
- Purchasing & Sub-Contracting
- Expediting & Quality Control

Construction Management Commissioning and Start-up

With the increasing complexity of industrial development and the emphasis on time and cost it is essential that new projects be entrusted to specialist companies which have the skills to handle the sophisticated integration and co-ordination of resources necessary to plan and implement the successful execution of your project.

EMS provides Total Project Capability and Design services offering to clients, on a competitive basis, the best contractor services and plant to the specified engineering and quality standards.

Contact EMS for your next project
We can design and build it on time and within budget.

EMS

For Total Project Capability in Action see
ENGINEERING MANAGEMENT SERVICES

ENGINEERING MANAGEMENT SERVICES LTD.

P.O. Box 585 Bedfordview 2008 Phone 011-539030 Telex 89041 SA

A member of the Murray & Roberts Group



G.K.S. 220



The Greatest Name in Plastics

AECI is in the forefront of the plastics materials industry, backed up by the high level of research, development and technical service the country has come to expect from us.

These brand names pioneered the plastics industry in South Africa:

- 'Alkathene' : Low density polyethylene
- 'Welvic' : PVC compound
- 'Corvic' : PVC polymer
- 'Perspex' : Acrylic sheet

Watch out for our new LLDPE — linear low density polyethylene — it may just start a minor revolution in the plastics world!



Plastics Division Carlton Centre P.O. Box 1122 Johannesburg 2000

International J16446

New threat to Natal sugar cane farmers

Own Correspondent

DURBAN. — Battered by the combined effects of drought and eldana worm infestations, Natal sugar cane farmers are being threatened by a third adversary — rising interest rates.

According to Mr Tony Ardington, chairman of the South African Cane Growers' Association, the high cost of re-establishing their drought-ravaged farms is forcing a number of farmers to sell up.

In his address at the association's annual meeting yesterday he warned cane farmers that they faced several years of financial stringency and that those affected by drought and eldana would be confronted with reduced incomes and increased costs in re-establishing their farms.

'Interest rates have increased alarmingly in recent months and in my opinion, they are going to rise appreciably further before the end of 1981.'

As an interim measure the association has attempted to expedite drought relief loans to farmers and has decided, in principle, to fight any future outbreaks of pests head-on with "extreme, early measures" of eradication.

Because of the problems faced by the industry last year the crop was reduced from an expected 2,3-million tons of sugar to a mere 1,6-million tons which reduced the country's export potential by 600 000 tons at a time

when world market prices were at their peak.

The result was that the growers had to borrow an additional R80-million to cover their losses from sugar sales and they now collectively owe a staggering R130-million.

According to Mr John Chance, the vice-chairman of the association, the repayment of the R130-million in loans is the most serious problem faced by the industry but he felt that a start could be made in paying back some of the commitment through this year's proceeds from export sales.

More positive aspects of the situation are that good rains have fallen over the entire cane belt since May which will help see the cane over the dry winter period and will do much to improve the current season's crop prospects.

In addition local sugar consumption is up by a better-than-expected 7 per cent which is encouraging in the long term as "the stable foundations of our industry are built on our local market."

In spite of the difficulties of the industry, Mr Ardington said they had been able to keep the domestic increase in the sugar price down to below the annual rate of inflation, in line with their policy of minimizing the cost to the consumer, and sugar was still currently being sold in South Africa at less than the cost of production.

BIBLIOGRAPHY

1. Amark, C
A Study in Alcoholism, in Kessel, N, Hawter, A and Chalke, A: Alcoholism: A Medical Profile, 1974, p. 31.
2. Bales, R F
Cultural Differences in Rates of Alcoholism in Quarterly Journal of Studies on Alcohol, 6, 1946.
3. Blane, A T
The Personality of the Alcoholic: Guides of dependency, New York, 1968.

R130m SA sugar debt

THE South African sugar industry owes R130-million in loans at a time when the world free market of sugar is unstable and makes dependence on it such a high risk business, Mr Tony Ardington, chairman of the S.A. Cane Growers Association, said in Durban yesterday.

He told the annual meeting "It is indeed unfortunate that our crop last year was reduced from an expected 2 200 000 or 2 300 000 tons under average rainfall conditions to a mere 1 600 000 tons, thus reducing our potential exports by over 600 000 tons at a time when world free market sugar prices peaked."

"Had we produced a normal crop, we would have been able to repay the R50-million we had borrowed to finance previous deficits in proceeds, and we would have been able to build up, once more, a significant stabilisation fund to tide us over periods of low world free market prices."

Worthington, N C
1972, Social Security Bulletin, 36, p. 40.

8. Dollard, J & Miller, N E
Personality and Psychotherapy in From Drinking to Alcoholism: A Sociological Commentary, London, 1976.
9. Gillis, L S & Slabbert, M
Survey of psychiatric Disturbances amongst the Cape People
10. Goodwin, D W et. al.
Drinking Problems among non-adopted sons From Drinking to Sociological 1976.
11. Horton, D
The Family in the South African Die.

12. Isaacson, C
The Changing Pattern of Liver Disease in South Africa, in S A Medical Journal, March, 11, 1978.
13. Kalj, R
Alcoholism in twins: Studies of the Aetiology and Sequel of Abuse of Alcohol in Kessel, N, Hawter, A and Chalke, H: Alcoholism a Medical Probita, London, 1974.
14. Keller, M
Alcohol and Health in: D Robinson, From Drinking to Alcoholism: A Sociological Commentary, 1976.
15. Keller, H & McCormick, I
A dictionary of words about alcohol. New Brunswick, N J Rutgers Center of Alcohol Studies, 1968.
16. Lisansk, S
Etiology of Alcoholism: the role of psychological disposition in Quarterly Journal of Studies on Alcoholism, 21, 1960.
17. Louw, E F
The Changing Drinking Pattern of the Black Population in South Africa and the emergence of the Problem of Alcoholism in Proceedings of the First South African International Conference on Alcoholism and Drug Dependence, I, 1974.
18. Merton, R K
Social Theory and Social Structure, New York, 1957.
19. Mc Ard, W & Mc Ard, F
Origins of Alcoholism, Standard Univ. Press, 1960, p. 28.
20. I & C A
A Five Year Mortality Study of Alcoholics, Journal of Occupational Medicine, 15, 1973.
21. A, South African National Council on Alcoholism and Drug Dependence: Information supplied to me, based on first-hand experience and close involvement.
22. Syme, L
Personality, Characteristics of the Alcoholic, Quarterly Journal of Studies on Alcohol, 18, p. 199.

VOLUNTARY COMMUNITY HEALTH WORKERS

the Dr Abdurahman Day Hospital in Kew Town. Due to their having been established for many years they housed a relatively stable community. Recent upheavals have been due to the younger generation reaching maturity, the riot of 1976 and the unemployment situation since 1977.

The formation of a team of voluntary community health workers to run a home based information service is described in this paper. On a recommendation of Dr John Smith, Medical Superintendent of the Day Hospitals Organisation, representatives of the Day Hospitals and the St. Johns Ambulance studied the feasibility of this innovation to the local medical scene in the Cape Peninsula. For many years trained members of St. Johns or other trained personnel applied First Aid after accidents and emergencies at sports meetings and other public gatherings. For a period of time they advocated that affected areas be visited by an Auxiliary Informator for AIDS - Auxiliary Informator.

The basic formula is that township or area will have a health worker based on the size of the population. These auxiliaries will be trained in first aid and first aid literature available and problems to Day Hospitals, clinics and social agencies specialising in a specific problem. They would literally and figuratively give direction to their neighbours.

When did this start?

The idea was first mooted early in 1977 and acted on later in that year.

Where was the idea first put into practice?

An initial pilot scheme was introduced in Kew Town, Bridgetown and Silvertown. These townships form part of the Athlone complex. They are 3 sub-economic housing estates built and managed by the Cape Town City Council and they form part of the area catered for by the...

If this pilot scheme is successful it will be developed into a major permanent service of the St. Johns Ambulance aided and abetted by the Day Hospitals Organisation. The service would hopefully be expanded to all the townships around the Cape Peninsula and its environs.

Sugar production this season would reach just under 1.9-million tons, of which more than 1.2-million tons would be sold in the domestic market five percent more than the previous season.

SUSTAINED RECOVERY

'It could well be that the current season will mark the beginning of a sustained recovery period for the South African sugar industry,' he said.

The past season, had been the worst in 10 years because of drought, with production falling 1.6-million tons and domestic demand rising 6.8 percent to 1.18-million tons.

The decline in production had coincided with a recovery in world sugar prices and had deprived the industry of the potential to increase its revenue by more than R200 million.

Mr Frank Jones, chairman of the South African Sugar Millers' Association, announced this at the association's annual meeting here.

He said the surplus would go towards redeeming the R130-million in loans raised over the past three seasons and some of the profit made in the export market would be applied to rebuilding the price stabilisation fund.

...that part of the population ... purchase directly or indirectly fee-for-service and can exert a system, but the poor are depend on 'clinic medicine' which tend dehumanized and lacking in content poverty group receive a different physical illness, but even the anxieties associated with illness according to social class. Med class commodity and the poor are discriminated against medically just as they are educationally."

The poor suffer severely from nearly every physical and emotional illness known. The causal relationship between poverty and ill-health is very well known. There is an inverse relation between income level and such conditions as malnutrition, infant mortality, tuberculosis and venereal/...

Small surplus expected from sugar exports
Argus 25/6/81
74 18p 3supp

Argus Correspondent

DURBAN. — The sugar industry has sold much of its export quota for the current season on the futures market at prices above the present free market price and is confident of ending 1981-82 with a modest surplus.

Sugar industry is in dire straits after drought

3 sugar
J. Times
28/6/01

CANE GROWERS WARNED OF POSSIBLE YEARS OF STRINGENCY

By Tony Hudson

THE South African sugar industry is in dire financial straits and could face further problems until the world sugar price reaches a level at which cane growers can obtain adequate returns.

At the annual meeting of the Cane Growers' Association, chairman Tony Ardington said: "It is my duty to warn members of the distinct possibility that the sugar industry could face a number of years of financial stringency before export prices reach sufficient heights to enable us to pay adequate cane prices while simultaneously repaying our loans."

Mr Ardington points out that because of the drought the sugar crop fell from an expected 2,3-million tons to around 1,6-million tons, leaving a shortfall of more than 600,000 tons at a

time when world sugar prices peaked.

He says that had the industry produced a normal crop it would have been able to repay the R50-million borrowed to finance previous deficits and start once again to build up the price stabilisation fund.

However, he says, the industry had to borrow an extra R80-million to cover most of the deficit, making the total debt in the region of R130-million at a time when the world sugar price is displaying all those unstable characteristics which make it a high-risk business.

A further gloom factor mentioned was the growing incidence of the eidana borer, which has confronted farmers already hard hit by drought with additional expenditure in re-establishing their farms.

Mr Ardington says that, besides the immediate cash deficits created by the reduction in crops, the necessity to replant and rehabilitate unusually large proportions of the total area under cane has called for heavy expenditure at a time when financial resources are at their lowest.

The problem here, says Mr Ardington, is rapidly rising interest rates. "Caught in the pincers of rapidly increasing costs of input and incessant demands for stable food prices — demands often supported by Government price controls — these farms are being forced to increase their borrowings and, having done so, are faced with the coup de grace in the form of impossibly high interest rates on these borrowings."

These factors had meant that a number of farmers have been forced to sell their farms.

Mr Ardington says, however, that because of the high level of liquidity in the economy, and — taking a swipe at the recent spate of purchases of northern Natal farms by Anglo-American — and specifically because of the injection of many millions of rands into the pockets of certain farmers by large outside interests, there has been an extremely strong demand for farms.

Since the overall supply is static, the price of farms has increased dramatically during the last year to the point where prices bear no relation to the economic realities that face the sugar industry.

However, he warned that the situation would not continue.

With the authorities' new determination to control the money supply, there is a possibility that the real price of farms will fall over the next two years.

Star 29/6/91

Modest surplus likely in sugar

Own Correspondent

DURBAN — The sugar industry has already sold much of its export quota for the current season on the futures market at prices in excess of the present free-market price and is confident of ending 1981-82 with a "modest" surplus.

This was announced in Durban by the chairman Mr. Frank Jones at the annual meeting of the South African Sugar Millers' Association. He said the surplus would go towards redeeming the R130-million in loans raised over the past three seasons.

He also hinted that some of the profit made in the export market would be applied to rebuilding the price stabilisation fund but did not give a cash breakdown between loan repayments and the fund.

Mr. Jones said that sugar production this season would reach slightly under 1.9-million tons, of which about 1.2-million tons would be sold in the domestic market.

PAST SEASON

"It could well be that the current season will mark the beginning of a sustained recovery period for the industry," he said.

In reviewing the past season, Mr. Jones said it had been the worst in 10 years because of drought, with production falling "dramatically" 1.6-million tons and domestic demand rising 6.8 percent to 1.16-million tons.

The decline in production had coincided with a recovery in world sugar prices and had deprived the industry of the potential to increase its revenue by an amount of more than R200-million.

Only 436 500 tons of sugar had been available for export — the lowest in 15 years but carry-over stocks of 169 000 tons had allowed the industry to fulfil its obligations to "our traditional markets, principally Japan and Canada."

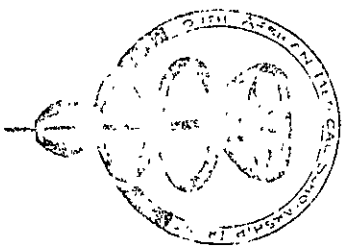

Paper No. 48

COMPREHENSIVE HEALTH CARE IN RURAL AREAS OF NATALBIELELAND

CONFERENCE ON THE ECONOMICS OF HEALTH CARE IN SOUTHERN AFRICA
SEPTEMBER 1978

SALDRU/SAMST

By Dave Canaing

DURBAN —The Tongaat-Hulett Group experienced difficult trading conditions in the first three months of its financial year and its earnings are below budget, says chairman Chris Saunders.

He told the annual meeting on Friday: "It is too early to make predictions about earnings for the full year, but in present circumstances of high interest rates, work stoppages and poor trading conditions we shall not equal last year's record performance."

He said the economy, particularly in Natal, had faced a decline caused by interest rates, mass protests and unrest. These factors had eroded confidence.

Group divisions were trying to improve earnings through better productivi-

Star 30 1980

Tongaat Hulett feeling the pinch

3 Saunders

ty and cost-reductions.

This, however, was proving extremely difficult because of reduced demand and greater price competition in the depressed situation.

"The building materials and textiles divisions have both been particularly affected and our problems are further aggravated by lower world sugar and aluminium prices."

The group, however, had a strong balance sheet and was well placed to weather the storm, he said.

FARMING (3) SUGAR Caning for sugar

FM 2/7/81
Despite record domestic demand, drought and parasites contributed to a dismal performance by SA sugar producers in 1980.

The industry made a loss of about R90m on total income of about R500m, although the government provided relief with R80m of guaranteed loans. Previous deficits have thus left the SA Sugar Association (Sasa) with a debt of R130m.

The situation is not expected to improve dramatically this year. In two separate meetings recently, SA Sugar Millers' Association (Sasma) executives and the SA Cane Growers' Association (Sacga), which together form Sasa, told members that the bleak situation will continue — notwithstanding high local demand.

In 1980, 1,2 Mt was consumed locally, a 6,8% increase over 1979. Exports, mainly to Japan and Canada, were at a low 435 500 t, the worst in 15 years. Because Sasa stockpiled some 169 000 t in 1979, the industry was able — just barely — to meet its contractual obligations. Privately, some sugar growers complain of their legal obligation to supply the domestic market first, at the expense of potential export sales.

Meanwhile, Sacga chairman Tony Ardington says: "It is my duty to warn

members of the distinct possibility that the sugar industry could face a number of years of financial stringency."

The problems are two-fold. Severe drought conditions in Natal and KwaZulu from January to August 1980 saw production plummet from an expected 2,3 Mt to about 1,6 Mt.

"Ironically, this drop in production occurred during the period of recovery in world sugar prices," complains Sasma chairman Frank Jones, "thus depriving the industry of the potential to increase its revenue by over R200m."

That R200m would have been sufficient to pay back the government-guaranteed loans built up in previous years and to build up future reserves.

The second major problem was the continued infestation of fields by the parasite *eldana borer*. The pest has caused so much havoc for farmers, according to Ardington, that "there have been cases where fields burnt before harvesting have been so infected by *eldana* that there has been nothing left to send to the mill."

The dry weather apparently helped the *eldana* thrive and spread. While Sasa's Experiment Station continues to research ways to combat the parasite, "there are as yet no solutions," Ardington says.

Part of the problem may lie with some sugar farmers who were reluctant to adopt the drastic measure of destroying crops to fight the parasite. Unfortunately, "there was the supposition that *eldana* infestations would disappear as in the past and, accordingly, both the Experiment Station and the industry were wary of pressing for the implementation of measures against the will of the owners of certain severely affected farms.

The combination of low output and *el-*

dana scourge forced some farmers to replant their fields and go further into debt. High interest rates exacerbated the financial burden.

"With the drought and the *eldana*, it's no wonder they say that to be a farmer you have to be an optimist. There is the old definition of a farmer as a poor man who is always going to be rich next year," Ardington muses.

Yet the situation for SA sugar producers remains pessimistic. Adds Jones: "There is no scope for any sizeable expansion of the industry at this stage."

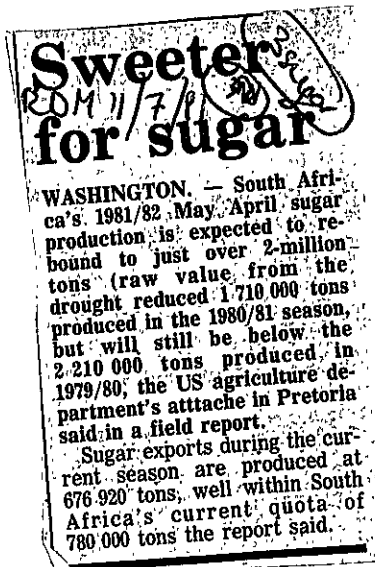

of the first year.
greatest promise at the end
For the student who has shown
Student Planners Award

URBAN &
REGIONAL
PLANNING

K Strong
subject of Building Construction.
For the second best student in the

C W von During
subject of Building Construction.
For the best student in the
S A Brick Association Prizes

III: No award
II : A R Low Keen
I : N D G Sessions
For the best student in each of
the courses of Building Economics I,
II and III in the third, fourth &
fifth years respectively.

LTA Prizes
P R Swift
For the student obtaining
the highest marks in
Professional Practice.
Surveyors' Prize
Cape Chapter of Quantity
The Committee of the Western

P C Key
For the best all-round student
in any year of study.
Bell-John Prize

QUANTITY
SURVEYING
(Continued)

Fire
NM 15/7/81
destroys

18 ha of
3 sugar
sugarcane

Crime Reporter

MORE than 1 200 tons of sugarcane were burned in a devastating fire which swept through 18 ha of cane lands near Umhlanga Rocks yesterday. Police are investigating a complaint of arson.

Mr Ron Phillips, Hulett's public relations officer, said that flames leapt 10 m in a fire-storm.

He said that in the past two months 234 ha of Hulett's canefields had been burned down in 57 cases of arson.

RDM 23/7/81
 Sugar price warning

Mall Correspondent

THE sugar industry "lost" R54-million on the sale of sugar in South Africa in the past season, said Mr I G B Smeaton, chairman of the SA Sugar Association, at the annual meeting in Durban yesterday. He warned consumers that a price increase could be expected.

He said that the domestic price had been based on a normal crop and not the low crop experienced.

If normal economic principles were applied to the 1980-81 season and costs were allocated between the domestic market and the export market on the basis of production achieved, the calculations reveal that a loss was incurred on the domestic sugar market.

The price-fixing policy had shielded the South African consumer for almost a decade from the effects of low world prices or low crops.

The sugar industry will endeavour to maintain the domestic price at as low a level as possible, but it must be recognised that at some stage in the future the industry may, because of overall debt levels, have to call on the public to pay a price for their sugar slightly higher than the cost of production for a short period.

Award who has shown at the end

Best student in the
 ing Construction.
 est student in the
 ing Construction.

SA Rival Association Prizes

III: No award

II: A R Low Keen

I: N D G Sessions

For the best student in each of the courses of Building Economics I, II and III in the third, fourth & fifth years respectively.

LTA Prizes

P R Swift

Professional Practice.

For the highest marks in

For the student obtaining

Surveyors' Prize

Cape Chapter of Quantity

The Committee of the Western

P C Key

in any year of study.

For the best all-round student

Bell-John Prize

PLANNING
 REGIONAL
 URBAN &

(Continued)

QUANTITY
 SURVEYING

CROOKES ³ sugar FM 24/7/81
Caned in SA

Activities: Cane growing and investment holding company. Also has sugar and agricultural interests in Swaziland. Investments include C G Smith (4,4%).

Chairman: T C B Crookes.

Capital structure: 3m ordinaries of R1. Market capitalisation: R28,2m.

Financial: Year to March 31 1981. Borrowings: long- and medium-term, R1,2m; net short-term, R4,4m. Debt:equity ratio: 12,1%. Current ratio: 0,2. Group cash flow: R2,4m. Capital commitments: R988 000.

Share market: Price: 940c (1980-81: high, 1 000c; low, 600c; trading volume last quarter, 11 000 shares). Yields: 7,7% on earnings; 5,3% on dividend. Cover: 1,4. PE ratio: 13,0.

	'78	'79	'80	'81
Portfolio value (Rm)	7,3	6,8	16,0	29,5
Div income (R'000)	782	669	705	1 191
Return on cap (%)	10,5	10,2	9,3	5,4
Turnover (Rm)	4,3	5,3	6,5	7,9
Pre-tax profit (Rm)	1,5	1,6	2,3	2,7
Earnings (c)	49,2	52,6	66,9	72,1
Dividends (c)	29	29	35	50
Net asset value (c)	588	644	998	1 547

As with the other sugar producers, 1981 was not particularly kind to Crookes. Poor rainfall affected the Natal crop and it was largely a substantial advance in investment income which allowed higher earnings. This year's prospects are better as acquisitions made close to the year-end should contribute to profit while dividend



Crookes . . . Natal drought cut sugar earnings

income should grow at least 33% to R1,6m (R1,2m).

SA operations contributed R921 000 (R1,3m) to pre-tax profit — a 31,2% decline. This resulted from a weather-reduced cane delivery of 174 200 t (243 100 t), despite the acquisition in the last four months of the Nkwalini Valley farms which added 3 200 t.

But, as with the acquisition of the Mount Albert Estates cane farm, no profit was contributed because of expenses incurred at the end of the cutting season.

Swaziland operations more than doubled pre-tax profit largely because irrigated cane crops are less vulnerable to the weather. In addition, the grapefruit and valencia orange crops improved.

Investment income reflects the increased dividends from C G Smith. During the year, Crookes bought a further 250 000 shares, taking its total holding to 1,5m shares with a R27m end-March market value. Changes to the portfolio included topping up the holding in Tongaat to 237 500 (170 000) shares and the purchase of a further 28 000 Metamin. The holdings in Safmarine and Palamin were sold to finance the acquisition of Mount Albert Estates.

Operating income		
	'80	'81
	R'000	
SA agriculture	339	921
Swaziland agriculture	279	563
Dividend income	706	1 191
Pre-tax profit	2 324	2 675

The agricultural acquisitions cost a total R6,8m, which meant borrowing R5,6m (nil). The resultant 12,1% debt:equity ratio is low and even allowing for a full year's charge, gross profit should cover the interest bill around six times. But the current ratio was hammered down to 0,2 (1,1) as the bulk of the borrowings (R4,4m) is short-term.

Besides using debt to pay for the acquisitions, Crookes has geared up to meet its R988 000 (R269 000) capex bill this year. Of this, R460 000 is to irrigate Nkwalini and boost cane production to a peak 67 000 t compared with 30 000 t expected in the 1981-1982 season.

This year the directors expect SA agricultural operations to improve with cane deliveries of 250 500 t (174 200 t). But with the cost of bringing Nkwalini to full production, no material contribution is expected. Swaziland expects a higher cane

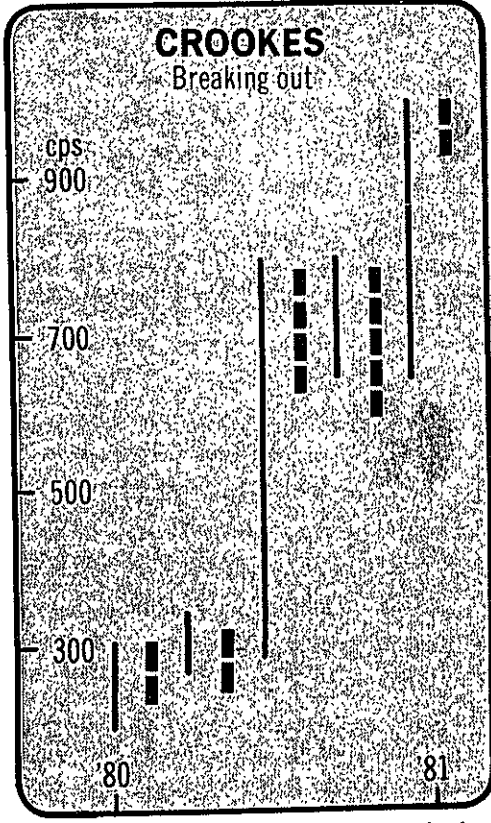

yield while the citrus division looks "promising" after last year's record. And a small return is anticipated from ranching.

Despite the promise of improved cane yields, the world sugar price is below year-ago levels. But even with a 10% higher domestic price, Crookes believes the industry will not receive its full proceeds in terms of the price formula. Swaziland, too, is subject to a lower international price for its increasing exports.

So, with an expected 33% growth in investment income, the directors forecast "at least" maintained dividends this year. But to justify the share's current 940c price the company will have to produce a distribution advance of at least 20%.

Des Kralea

reward or reinforcement. According to Dollard et. al. (Dollard & Miller, p. 54):

"...alcohol is reinforcing because it results in a reduction of fear, conflict and anxiety."

From this it follows that a person or groups of people who are repeatedly subjected to environmental stress are consequently more prone to drink anaesthetic qualities of alcohol than those individuals who experience less stress and for whom, therefore, alcohol has only a weak reinforcing value.

Psychoanalysts concentrating on alcoholism (and problem drink-

alcoholism lies in their application to rehabilitation and therapy.

4.3 SOCIOLOGICAL THEORIES

There exists in Sociological literature a vast amount of theoretical writing about problem drinking. Within the scope of this paper only the most noteworthy can be discussed.

Sociological theories postulate a causal relationship between the development of some kind of alcohol problem and the sociocultural setting in which that problem is located.

Debts point to pricier sugar

By Tony Hudson

THE already hard-pressed man-in-the-street may face another sugar price increase in the near future because of the high level of debt in the sugar industry.

Retiring SA Sugar Association chairman Ian Smeaton told the association's annual meeting in Durban this week that the domestic price of sugar increased at a rate less than that of inflation.

He said that the domestic price calculations were based on a normal crop and if normal economic principles were applied to the 1980-1981 season, and costs were allocated between the domestic market and the export market on the basis of production actually achieved during the season, the calculations reveal that a R54-million loss was made on the domestic market.

He told the meeting that, while the industry will endeavour to keep the domestic price as low as possible, the high debt levels of the industry may force it to ask for a price that is higher than the cost of production for a short period.

He said that the move will depend on the world sugar price, as it is the export market that will have to generate sufficient revenue to repay outstanding loans and start rebuilding the sugar price stabilisation fund to a level where it can once again shield the industry from major price fluctuations.

He said that the 1980-1981 crop of 1,6-million tons was 27% below the potential of 2,2-million, and that this was the sixth successive season where a shortfall had been experienced. He said the total shortfall for the period was R257-million.

Of this, R97-million came from the price stabilisation fund, which was cleaned out, R130-million in interest-bearing loans from local and overseas banks and the balance of R32-million as a reduction in the entitled returns on capital of millers and growers over the past three seasons.

If the local price does increase, the ripple effects will be marked.

Not only did direct domestic consumption increase by 4% last year, but offtake by mineral water manufacturers was up by 28% and sales to cordial and squash manufacturers up by 21%.

symptoms like anxiety, depression and sexual insufficiency.

(c) Alcoholism develops in response to an inner conflict between dependency drives and aggressive impulses.

The main problem with these theories are the difficulties that arise with any effort to subject them to experimental testing and verification.

The important value though of psychoanalytic theories about

ried a relatively high amount of anxiety (created by a structural condition within the society) to be the main contributory variable to a generally high level of insobriety.

The process of acculturation was also assumed to create high levels of anxiety. Horton demonstrated that those societies in which he found evidence of acculturation in progress were also categorized by extremely high levels of insobriety.

Bales proposed three ways in which culture and social organization can influence the rates of alcoholism:

Take pp 9-16

Ethanol

and cane

Alliance

3 81991

The future of the sugar industry in South Africa may be closely tied to the production of ethanol fuel from sugarcane.

This is the view of Mr. Dick Ridgeway, chairman of the S A Sugar Association.

Submissions have been made to the Government committee of inquiry into the sugar industry containing all the information it has been possible to obtain and making a case for the production of alcohol as a fuel, he says.

Given a sufficiently flexible attitude by Government in relation to the relevant taxes, the cost of ethanol production compares reasonably well with that of methanol made from coal, and the sugar industry is well set up to produce significant quantities of the former, he said.

But there are many complications that are not publicly known. It is naturally impossible to obtain all the details of the Government's future energy plans.

Therefore it is most difficult to weigh up the economic and strategic merits and demerits of ethanol as part of the overall fuel scenario, said Mr. Ridgeway.

But once the Government receives the findings of the sugar committee of inquiry, uncertainty in this matter ought to be removed.

If ethanol production from sugar cane does have a place in the nation's long term fuel plan, the Government must clearly define the conditions under which this would take place.

Energy plan

But if this is not the case, then it must be asked whether it is not possible to amend the energy plan to allow for the production of a sufficient but, in the overall context, a relatively small quantity of ethanol. This would allow expanded sugarcane production in the self-governing States and other areas, which cannot be economically developed under any other crop, he said.

Mr. Ridgeway said that the Government and the sugar industry had been subjected for some time now to pressure from areas such as Transvaal, Eastern Transvaal, KwaZulu, self-governing States and various members of the existing industry to expand sugar production.

It is well understood that expansion of sugar growing represents a major opportunity for the creation of employment and wealth in the areas mentioned, and a practical means of strengthening the economies of agricultural areas which need to be more densely settled for strategic purposes or which are unable to maintain their viability through other crops.

Against this it is equally clear that these ends will not be achieved if expansion takes place on a scale which jeopardises or destroys the stability of the industry itself.

There are many differences of opinion in this matter but it seems reasonably clear that with the uncertain and unsatisfactory position of world sugar price and with predictions of major expansion, sufficient expansion to satisfy all those interested will not be recommended by the committee of inquiry, unless an alternative sugar industry product such as ethanol is available.



Mercedes-Benz



SOUTH AFRICA'S FASTEST GROWING
MERCEDES-BENZ DEALERSHIP
115 OLD MAIN RD., PINETOWN, TEL. 229913

Don't be afraid of water!

Large water volumes, high heads, confined areas, siltage, contaminated water. Whatever problems you have on your building site, Flygt can solve them - quickly!

Flygt has the world's largest range of drainage pumps. They are all submersible and need to sit in the water. You simply lower them into the water - and then they take care of themselves for weeks and months at a time without attention.

They are reliable thanks to double mechanical seals, impellers of extra steel and rubber-lined wear components. They can take almost anything, including dry running.

Talk to Hugh Mellor about the drainage problem you have on your building site. We have Flygt's complete range of drainage pumps in stock.

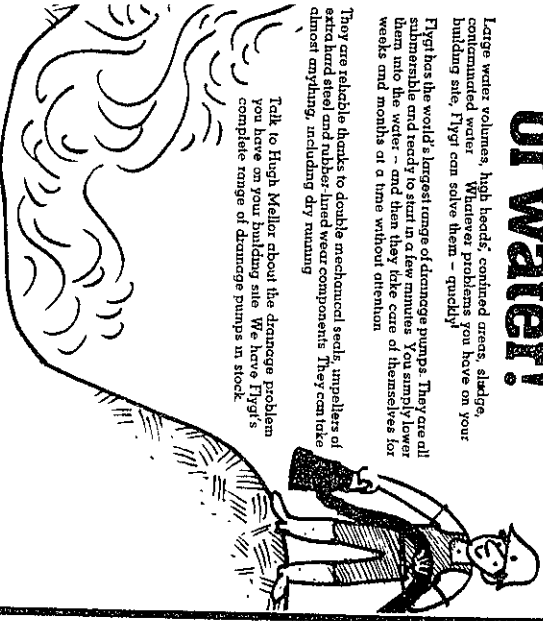

Hugh Mellor & Company Limited

Barcelona, Johannesburg 011 1 606 4020
Buenos Aires 1 22 801
London 01 234 1111
Pretoria 011 22 428 74
Rome 06 47 81 11
Santiago 021 2 42 87 4
Sao Paulo 011 50 42 87 4
Tampa 081 3 42 87 4
Tel Aviv 03 42 87 4
Tokyo 03 42 87 4
Winnipeg 031 3 42 87 4



MAASFI

CONICAL LIQUID-RING VACUUM PUMPS

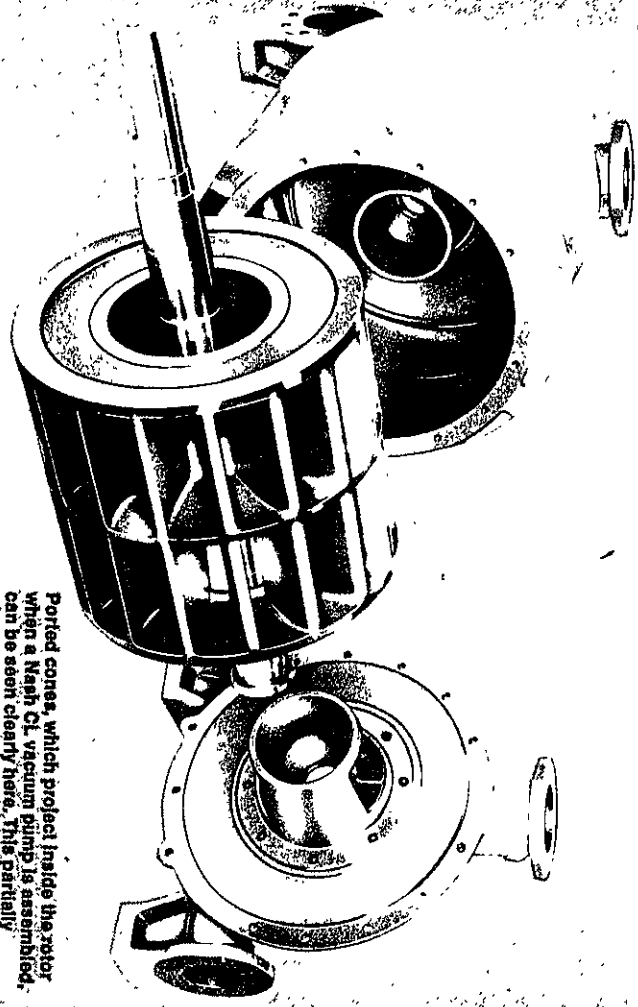

Ported cones, which project inside the rotor when a Maasfi vacuum pump is assembled, can be seen clearly here. This partially assembled view also shows the stator at both ends and in the middle of the solid cast rotor.

MANUFACTURED IN SOUTH AFRICA



Please write or phone for literature to
SANDOCK-AUSTRAL LTD.
PUMP DIVISION

P.O. BOX 14269, WADEVILLE 1422. TELEPHONE (011) 34-1536, TELEX 8-8544 S.A. DURBAN OFFICE: P.O. BOX 12444, JACOBS 4026. TELEPHONE (031) 47-5611

Get it all from Haggle

Haggle chain and chain hoists

All grades and sizes of chain plus a full range of hoists.

Product range includes:

- "Herc-Alloy" lightweight lifting chain.
- High tensile and mild steel short link, long link and loghaul chain.
- Alloy hooks, rings, links, hammerlocks, shackles
- Chain hoists (manual or electric) with standard lift or claimed to individual requirements
- Load binders and pullers

Haggle wire rope fittings & accessories

A large and comprehensive range in commercial grades and to all international specifications (USA, Federal, BSS, SABS).

Product range includes:

- Clamps
- Hooks
- Shackles
- Rings and Links
- Sockets
- Rigging and Straining screws
- Blocks
- Thimbles
- Eye bolts
- Rope cutters

If you want a comprehensive range of products and services – and safety with performance is vital – it's reassuring to know Haggle's been in the business for over 60 years, building up an unrivalled reputation for technical competence.

And when it comes to supplying the sugar industry, we are right on your doorstep with a comprehensive range of products from harvesting and milling through to refining and transportation, including such products as Johns-Manville filter powders and cartridges, tarpaulins, nets, cane trailer cables, fibre ropes and abrasion resistant steels. Call Keith Pulford, Bert Herholdt, Gary Wilson (Durban Branch Tel. 45-41311); Don Robertson, Praigie Moodley (Richards Bay Branch Tel. 51321); Leon van Rensburg, Bobby Govender (Pietermaritzburg Branch Tel. 28521/2) for further information.



Haggle slings

Manufactured in a range of materials to suit all lifting requirements

Product groups:

- Steel wire rope slings, hand or mechanically spliced (Superloop or Atyp)
- Alloy chain slings with a variety of end fittings and a safe mass load of up to 74 tons (2 legged)
- Manila, nylon, polypropylene hand spliced slings
- Nylon webbing slings

Haggle rigging & splicing service

Qualified riggers, ropemen and technical specialists on hand throughout the country to advise on all types of rope and chain applications

Range of services includes:

- On-site splicing and socketing
- Rope installation, inspection and repair
- Proof loading facilities to pre-test slings, chain, fittings and accessories

haggle

Haggle Rand Limited

Head office & Johannesburg branch
Lower Gernsion Road, Juniper, Johannesburg
P.O. Box 40072, Cleveland 2022. Tel: 613-1511. Telex: 8-7187 SA.
ROBBERSTEIN Tel: 72056 • CAPE TOWN Tel: 51-0990 • DURBAN Tel: 45-41311 • EAST LONDON
Tel: 28521/2 • PORT ELIZABETH Tel: 72811/21 • NEWCASTLE Tel: 22527 • PIETERMARITZBURG
Tel: 28521/2 • RICHARDS BAY Tel: 51321 • WINDHOKOR Tel: 61333 • WITBANK Tel: 541
• WELKOM Tel: 2-8887 • WINDHOKOR Tel: 61333 • WITBANK Tel: 541
A more detailed chart of these product groups is available from
any branch office.

MH1107



CHARLES VAN DER MERWE
Sales Manager

NOTHING'S A MISSE!

Backed 1

Dalcel
TRUCK 8
031 426



TONY DONE
Sales Manager

NOTHING'S A MISSE!

Backed 1

Dalcel
TRUCK 8
031 426



DAVID JO GEYERA
Manager

NOTHING'S A MISSE!

Backed 1

Dalcel
TRUCK &
031 426



Serving the North Coast

Thompsons Butcheries serve the needs of the farmer, industrialist, hotelier, restaurateur and householder on the North Coast

Six branches

Branches at Urnhall, Stanger, Darnall, Urnhall, Balliloville and Umhlanga Rocks ensure fast, efficient, deliveries

Contracts

Discuss your needs with Thompsons. We'll show you how to ensure economical supplies of quality meat

THOMPSON'S BUTCHERIES

Ventham (Head Office)
Telephone (032222) 8 and 170
Balliloville - Telephone (032242) 261
Darnall - Telephone (0324) 6221
Stanger - Telephone (0324) 21412
Urnhall Telephone (032222) 41 and 129
Umhlanga Rocks - Telephone 512081

SUGARMECH '81

New utility tractor will be on display

ON show at Sugarmech will be the newly-released MF 220 utility tractor.

The MF 220 is part of a new line of compact tractors from Massey-Ferguson. It is designed to supplement the famous Ferguson System Tractors by offering extra economy and versatility.

In the past few years, demand for larger powered tractors has grown and conversely the demand for smaller economical tractors has also increased considerably.

Prior to this time, tractors such as the old Vaalapie, Ferguson, 8N and 9N, Fords and the larger air cooled garden tractors have been attempting to meet this market. Such tractors have been becoming increasingly scarce due to the growing market demands. We have also seen Kubota, Yanmar and others making an increasing appearance.

The MF 220 is aimed at three primary markets, the first of which is the weekend farmer or the smallholder.

The second of these markets, the utility segment, is more diversified and consists of industrial plants, golf courses, municipalities, nurseries, vegetable farms, supermarkets and fresh produce markets to name

but a few.

The third and probably most important market is the home-fide farmer. The MF 220 has a place on any farm - whether it be used for cultivation between 2.1 m rows of maize, to spray tomatoes or vineyards, to rotavate in a fruit orchard, or for general transport or muck handling.

To cater for all these different purposes, the MF 220 is available in two different basic models.

The two wheel drive is equipped with turf tyres and in this golf course configuration is intended primarily for the utility markets.

The four wheel drive is equipped with standard agricultural tyres and features a very sensitive draft control mechanism. The two cylinder engine in the MF 220 has been fitted to more than 225 000 tractors and proved throughout the world. It is steel cast while most competitors use die cast aluminium blocks and heads. Engine cooling is by a pressurized water system for better temperature control in heavy work conditions.

The radiator is protected by an easily removable chain screen. The MF 220 features a 12-speed forward and

three-speed reverse transmission accomplished by a four-speed forward and one speed reverse with three range selections. The combination sliding mesh spur gear and constant mesh gear transmissions provide all speeds from

except for transport. The mechanical design of the front axle is unique. The power flow from the differential is transmitted to the wheels by a near straight line axle shaft with a universal joint which allows the front wheels to turn.

The onboard gear reduction at the wheel reduces torque loads on the axle and differential and gives maximum torque to the wheels. Drive to the front axle is from the rear pinion shaft by means of a direct splined drive shaft. No costly universal joints are needed.

Four-wheel drive can be engaged and disengaged by a shift lever that controls a sliding gear. When engaged, the front wheels turn slightly faster than the rear wheels to provide maximum traction.

The added traction of the four-wheel drive feature allows the customer to maximize engine power efficiency when using ground engaging implements.

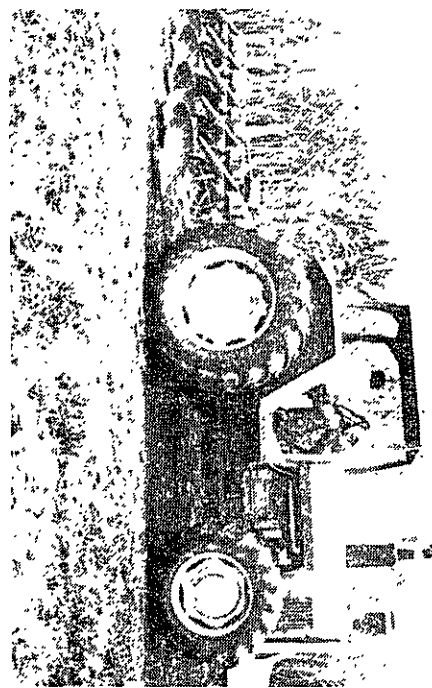

The Massey Ferguson 2640, which will be seen for the first time at Sugarmech.

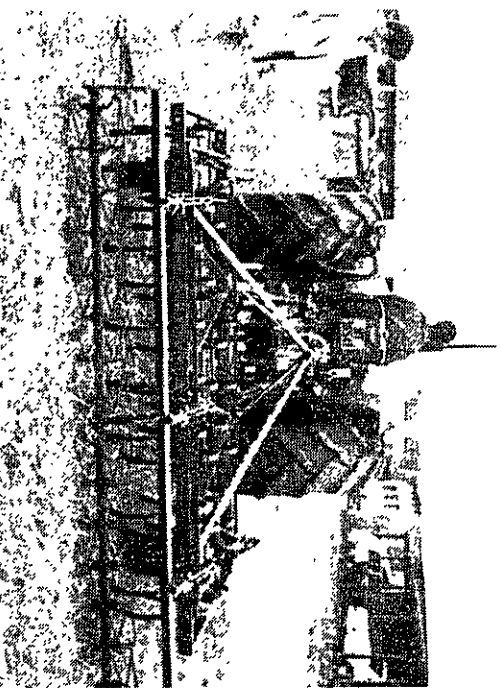

The Kongsjilde SGB, which will be on show at Sugarmech, may be the answer to stool eradication. Seen with the machine is Mr John Lindsay, managing director of Multiple Farm Equipment, Massey Ferguson dealer.

Concern at low rainfall

THE 1981-82 season is facing a further spectre of drought with minimal rainfall since February. Cane growers, Association president Ernie Morrison, does not view it as being as severe as last season's drought, but there is still concern at the low rainfall.

December and the first part of January were bad. Then the February rains gave the growers hope. But March rainfall was badly down and as there wasn't a good fall over the Easter period the season is going to suffer. Autumn and winter in Natal and Zululand have always been the dry periods of the year.

The February figures fell just below the long-term mean, but the rainfall throughout the year has been very erratic. January's figure, for example

was relatively good. The bulk of the rain fell the last two days of the month. Most of this storm fell ran off, or was dried up by the following hot days.

The most dry area, according to Dr Gertrude Thompson of the Experiment Station, was around Amathuku. Here the total March figure of 238 mm compares with long-term mean of 126 mm. And there was so little rain in March in many areas that many of the cane fields are now getting depressingly brown.

Another dry season is falling world sugar prices mean that this highly port orientated industry likely to face an acre in the \$150 million of losses over the past few seasons.

Drought cuts exports

THE effect of the drought has reduced exports by 43.5 percent and lost the industry a conservative R250 million.

In spite of the drop in the International Sugar Agreement quota at the beginning of 1980 and the world price reaching its highest level in five years, tonnage for export were low because of the severe drought.

The average tonnage the industry can produce is now estimated at around 4,200,000 tons a year, but the 1980-81 season produced only 2,010,000 tons, according to the Phosphate Mail.

The industry is committed to supplying local demand first. This absorbed more than 1,000,000 tons. Fortunately, the Sugar Association was able to

meet its contractual obligations from 1,595,279 tons sent abroad during the season. The minimum Japan requirement of 350,000 tons was met with a dispatch of 367,722 tons. While this exceeded the minimum was down on the 1976 total by 90,494 tons.

The Canadian contract minimum had been set at 215,000 tons, but this was reduced to around 180,000 tons, mainly at Canda's request. Even the 174,000 tons drop the deficit, the previous season of 9,113 tons.

Most noticeable was amount available for export to the U.S. In 1979, America took 122,488 tons but this fell last season to 74,828 tons to 47,560 tons.

The tonnage export include 5,340 tons of best molasses (HTM), added to the raw sugar at time of loading shipment.

Get it all from Harrow



SUGARMECH '81

LAYOUT OF DEMONSTRATION SITES

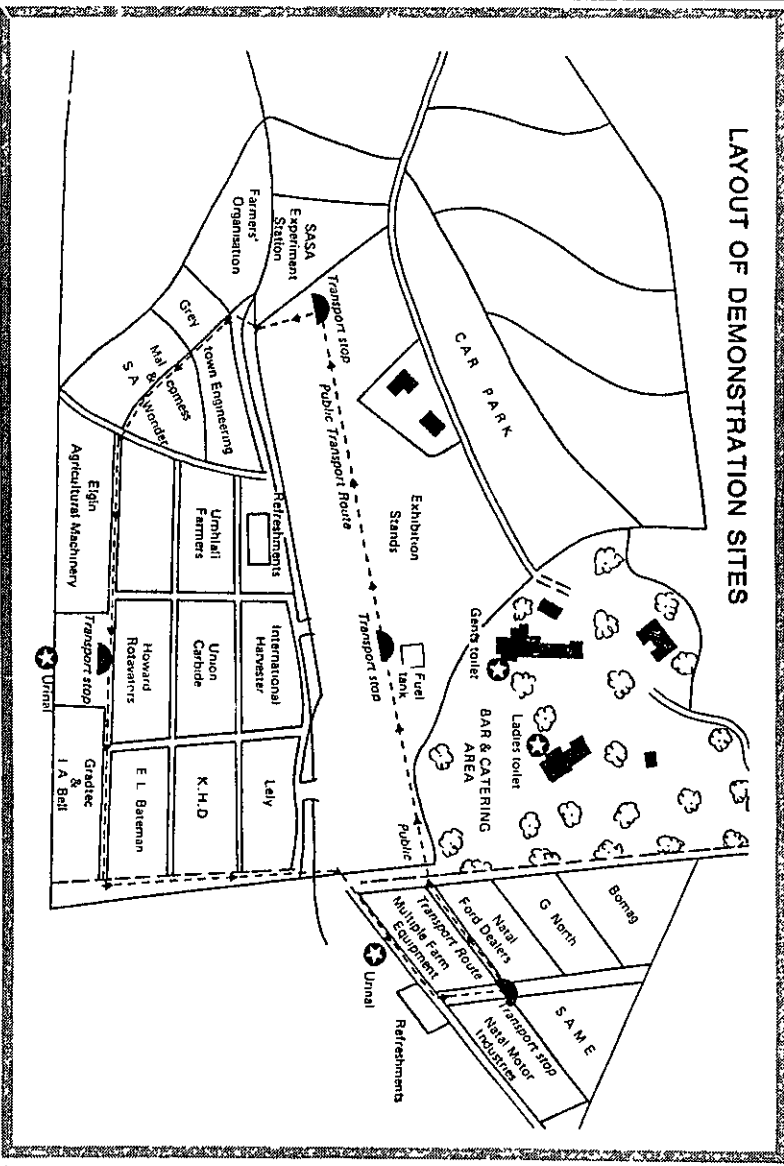

THE TOTAL CAPABILITY COMPANY

DIESEL-ELECTRIC

BOSCH SERVICE

AUTOMOTIVE PARTS & ACCESSORIES, RELIABLE INDUSTRIAL & CONSTRUCTION MACHINERY, RUGGER INDUSTRIAL TOOLS, SPECIALISED SERVICE, FINEST DOMESTIC APPLIANCES

BOSCH

FRANK

TOP EQUIPMENT HIGH PRESSURE CLEANERS

SEE YOU AT THE MECH!

Wason & Dobson

TURO

Unchokable pumps

AMCA ALUMINIUM CABLE

Dowson & Dobson

191 SYDNEY RD, CONGELLA, DURBAN, 4001
 BOX 978, Durban 4000. Telex No. 62461, Phone 252341

Items of Mechanical

- STEEL STRAPPING
- RIS CONTROL VALVES
- SUGAR SCREENS
- WOMEN MESHES
- HAI VALVES 1 P.V. BALL
- V. QUARTER BUTTERFLY
- T. WAFER CHECK
- 3 AND SPECIAL APPLICA

Distributors of Electrical

1. AWCO ALUMINIUM CABLES
2. AWCO CABLE LUGS
3. HIRE OF 60kn & 200kn CRIMPING EQUIPMENT (67 & 207)
4. POWER FACTOR CORRECT. EQUIP. MENT & SUBVERS
5. (A) ICBAR 18KV & 33KV/Ar CAPACITORS
6. (B) DOMINI SINKVA UNITS
- 5 (A) HT & NON-HT 11 KV UNITS
6. LAURENCE SCOTT MOTORS

— CANE TRUCK SPARES

— PIPE TOOLS

— PUMP TOOLS

— WAJER FITTINGS

— PUMPS

— AIRLINE EQUIP.

Bulk silos ease strain

THE three bulk sugar silos in Durban built at a cost of R18m, have revolutionised the handling of S.A. export sugar since 1980.

Like other bulk-handling installations in the port, the Terminal has eased the strain on the berths in the harbour.

In pre-terminal days, using an 18 000 ton ship, it would have taken 65 ships 990 days to load 1 000 000 tons of sugar at one berth. It is now possible to load the same number of ships in only 55 days.

That frees the one sugar berth for the remaining 310 days of the year for other vessels.

And with an export availability of around the 1 000 000 ton mark (except in years of drought or quota restriction), this is an essential installation.

The original idea was

mooted in 1960, when the Bulk Sugar Advisory Committee was faced with a ten-point objective.

REDUCE:

- handling costs of export sugar
- sugar losses

RELIEVE:

- congestion of ships in the harbour
- railway truck shortages
- manpower shortages

ACHIEVE:

- sugar at short notice for export
- uniformity in quality
- space to handle more than one type of sugar
- improvement in quality

PREVENT:

- deterioration of sugar in storage

The result was the construction of the first sugar terminal of 180 000 ton capacity in 1965. The other

two followed in 1968 and 1972, with an eventual storage capacity of 520 000 tons in total.

There remained one problem to overcome. The quality of export sugar was not significantly improved. The trouble here was that refineries in some countries with government protection laws, had to import sugar at a lower polarity than the 99.4% of the local product. Japan, for example, needs an import polarity below 98%, and the U.S. sugar at below 99%.

As polarity can be reduced by coating with molasses, the mills originally had to supply sugar coated with final molasses.

This was a slow (no more than 27 ton an hour) manually controlled process. And the polarity of sugar supplied by different mills showed a wide disparity.

But while the high polarity sugar can be stored for lengthy periods without any quality drop-off, molasses-coated sugar deteriorates comparatively quickly.

After a detailed examination, it was decided to erect a plant which would coat the sugar crystals with selected molasses immediately before shipment.

This would prevent deterioration of the molasses film, ensure uniform quality and allow the silos to store only one type of sugar.

But the handling of molasses presented a major problem. The substance is so viscous it does not follow fundamental laws (Poisuille's law) governing the flow of materials, and it also has poor thermo-conductivity.

This was also remedied by pre-shipment coating.

The problems of storage, variations in polarities and moisture content, were therefore all cured. The R720 000 molasses mixing plant was commissioned in 1976 and its accuracy in coating sugars to a polarity of 97% or 98% has run at 0.05 percent error.

He will be glad to advise you. Not only about lubricants but also about BP's comprehensive range of guaranteed products for the farm. He'll help you save money.

Tractor Oil Unlimited

Not yet using BP Super TOL? Come and talk to your BP man.

Your BP man has lots of bright ideas to help you save money. Let him tell you about BP Super TOL. The one oil for the farm. And the money saving two-component motor oil for your two-stroke BP Energolite Universal

SAVE WITH TV!

BP

We like to keep you moving.

PHILIPS MOBILE RADIO DIVISION

PHILIPS

THE TOTAL CAPABILITY COMPANY

RADIO SYSTEMS - DESIGN AND ENGINEERING, MOBILE UNITS, PORTABLE UNITS, REPEATERS, LINKS AND BASE STATIONS, FULL SERVICE BACK UP THROUGHOUT NATAL

FOR FURTHER INFORMATION PLEASE WRITE, PHONE OR CALL PHILIPS TELECOMMUNICATIONS (PTY.) LTD.

117 UMBILO ROAD, DURBAN, 4001
 P.O. BOX 18062, DALBRIDGE, 4014
 TELEX 622702

TELEPHONE 312016

Not yet using BP Super TOL? Come and talk to your BP man.

Your BP man has lots of bright ideas to help you save money. Let him tell you about BP Super TOL. The one oil for the farm. And the money saving two-component motor oil for your two-stroke BP Energolite Universal

BP

We like to keep you moving.

Not yet using BP Super TOL? Come and talk to your BP man.

Your BP man has lots of bright ideas to help you save money. Let him tell you about BP Super TOL. The one oil for the farm. And the money saving two-component motor oil for your two-stroke BP Energolite Universal

BP

We like to keep you moving.

THE LAST WORD IN LOCAL BLADE MANUFACTURING.

Many people still believe that to find a precision blade you have to look to foreign lands, Switzerland, Germany, England or America. They don't make that type of blade in South Africa or 'The quality of locally manufactured blades is not up to scratch', are some of the reasons given for this uninformed opinion.

Well, we're going to squash all these totally unjustified assumptions with one word - SULZER. Sulzer are manufacturing a range of the finest precision blades, available anywhere in the world, right here in South Africa. This gives you all the economies of a local source. You save valuable foreign exchange, international freighting problems and time. Without sacrificing quality.

At their Market Street, Johannesburg premises Sulzer are fully equipped with up-to-date machine tools and instruments to handle virtually any blade application. From steam turbines through blowers, expanders and axial compressors to gas turbines. Their aerofinishing capability ranges from 20mm to 1,200mm in length and from 1.0mm to 24.0mm in chord. What's more, their facilities allow them to reproduce new blades to any design.

Every locally manufactured blade goes through a series of stringent quality checks: 100% dimensional checks, 100% hardness tests and 100% magnitudic check tests. The result is a blade that is on a par with, if not superior to, the finest blades in the world. After all, when it comes to blades, working with such fine tolerances, there is only one quality - perfection. When all is said and done, with Sulzer manufacturing a product of such high quality right here in the Republic, there really is no reason to look anywhere else.

For information on any aspect of blade manufacture call Sulzer
260 Market Street, Johannesburg
Tel (011) 618-4125



Sulzer Bros (South Africa) Limited
P.O. Box 930, Johannesburg 2000
Durban 39 Station Road, Stamford Hill, P.O. Box 1877, 4000 Tel 33-5543
Cape Town 15 Napier Street, P.O. Box 6913, Roggebaai 8012 Tel 21-5650

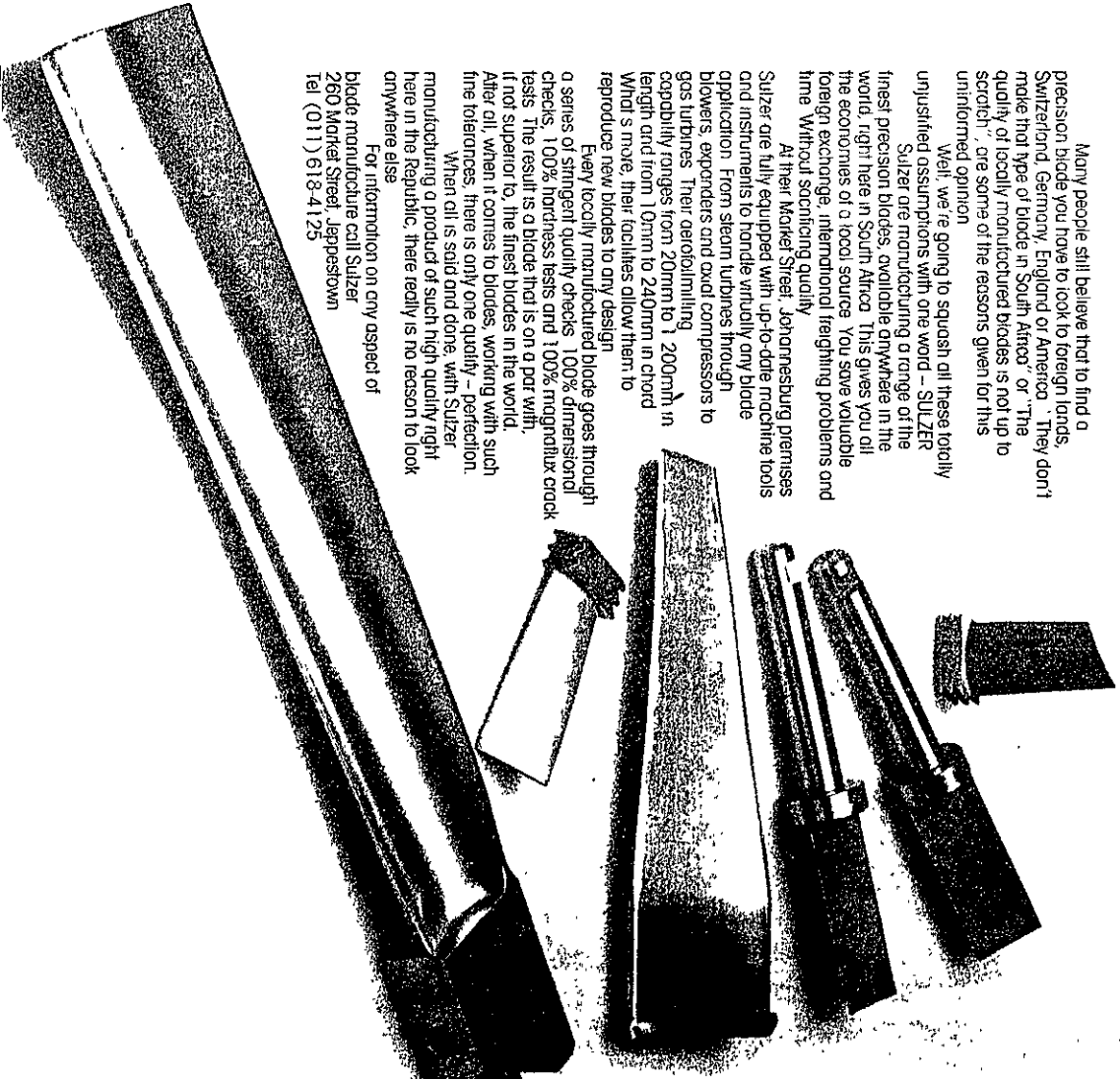

Heavy Duty Casings Δ Reg 9277A, Merc.

Launch an air attack on weeds in sugarcane

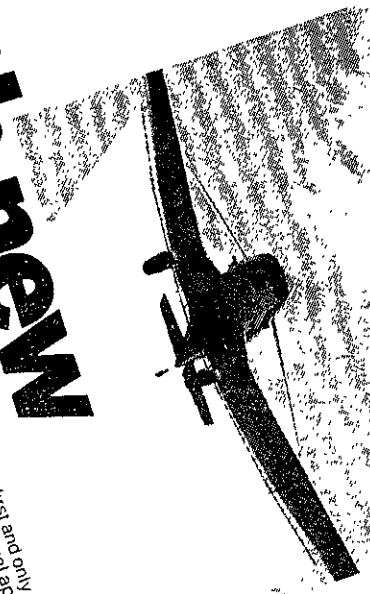

With new DOPAX

DOPAX is the first and only registered herbicide for a later application in sugarcane. Aerial application of DOPAX, following areas can be done at any time of the year. It is economical, easy to use, and has no effect on the crop. It is a selective herbicide, killing weeds and grasses, but leaving the sugarcane plants unharmed. It is also effective against weeds and grasses that are difficult to control with other herbicides. It is a long-acting herbicide, providing protection for several months. It is also effective against weeds and grasses that are difficult to control with other herbicides. It is a long-acting herbicide, providing protection for several months. It is also effective against weeds and grasses that are difficult to control with other herbicides.

be sprayed in a short time, up to 50 hectares per hour. It is also effective against weeds and grasses that are difficult to control with other herbicides. It is a long-acting herbicide, providing protection for several months. It is also effective against weeds and grasses that are difficult to control with other herbicides.

Winter can be treated with DOPAX. In addition to the above information, further information can be obtained from CIBA-GEIGY, P.O. Box 100, Capetown.

DOPAX controls broadleaf weeds, grasses and other unwanted plants. It is also effective against weeds and grasses that are difficult to control with other herbicides. It is a long-acting herbicide, providing protection for several months. It is also effective against weeds and grasses that are difficult to control with other herbicides.

Control weeds and grasses in sugarcane. DOPAX is the first and only registered herbicide for a later application in sugarcane. Aerial application of DOPAX, following areas can be done at any time of the year. It is economical, easy to use, and has no effect on the crop. It is a selective herbicide, killing weeds and grasses, but leaving the sugarcane plants unharmed. It is also effective against weeds and grasses that are difficult to control with other herbicides. It is a long-acting herbicide, providing protection for several months. It is also effective against weeds and grasses that are difficult to control with other herbicides.

Control weeds and grasses in sugarcane. DOPAX is the first and only registered herbicide for a later application in sugarcane. Aerial application of DOPAX, following areas can be done at any time of the year. It is economical, easy to use, and has no effect on the crop. It is a selective herbicide, killing weeds and grasses, but leaving the sugarcane plants unharmed. It is also effective against weeds and grasses that are difficult to control with other herbicides. It is a long-acting herbicide, providing protection for several months. It is also effective against weeds and grasses that are difficult to control with other herbicides.

Control weeds and grasses in sugarcane. DOPAX is the first and only registered herbicide for a later application in sugarcane. Aerial application of DOPAX, following areas can be done at any time of the year. It is economical, easy to use, and has no effect on the crop. It is a selective herbicide, killing weeds and grasses, but leaving the sugarcane plants unharmed. It is also effective against weeds and grasses that are difficult to control with other herbicides. It is a long-acting herbicide, providing protection for several months. It is also effective against weeds and grasses that are difficult to control with other herbicides.

CIBA-GEIGY
P.O. Box 100, Capetown
Tel 021-423-1111

SUGARMECH '81

CONTROL INSTRUMENTS (NATAL)

AVIATION SERVICE
 LEITCH HOGG, VIBRACORDERS, TIME RECORDERS,
 JOB COSTERS, NIGHT WATCHMEN'S CLOCKS, PRESSURE
 OPERATING GAUGES,
 CHLORINE
 ANALYSERS, MECHANICAL ZURBURG: 53222; DUNDEE: 21977;
 EDINBURGH: 5366; PORT SHEPHERD: 21996; EMPANGENI: 25390.

Brazier's

**THE SUGAR INDUSTRY...
 OFFER THE BEST IN**

**BE CLEANING
 EQUIPMENT**

Flextube

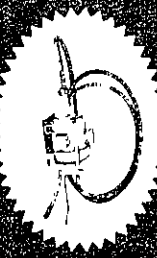

**WATER
 TRANSMISSIONS**

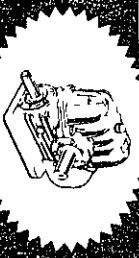

CHINESE TOOLS

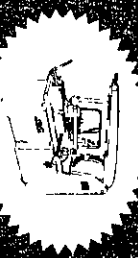

WATER TOOLS FOR INDUSTRY

Decker • Bosch • Makita • Pol

MATERIALS HANDLING EQUIPMENT



CONCRETE SIDING MATERIAL

SIT OUR SHOWROOMS (OPEN SATURDAYS)
 100 RIBBAN 350 GALE STREET, PHONE 256431
 100 TERMARIBBURG, 197 GREYDING STREET, PHONE 21513

**Minimum
 tillage
 as an
 answer**

THE drought has made it necessary to plough out far greater areas than normal for re-establishment and the recent arrival of the rains has caused a rush by cane farmers to plant as soon as possible to recover lost growth, and the quickest way to achieve this is through minimum tillage.

The old crop, which in many cases, may be dead or dormant, should be eradicated, or killed quickly if BSD is to be avoided and, since there is no single piece of equipment which can achieve this mechanically in one pass, chemicals such as Round-up should be used.

The preparation of a suitable tilling and fertilising, however, are still time-consuming, expensive operations. Many attempts have been made to adapt existing equipment but Elgin Agricultural Machinery claim that they have designed a machine specifically to fulfil the farmers' needs.

The Elgin minimum tiller can provide a planting tilling in the form of a narrow strip 220 mm wide and 230 mm deep between or across the old cane rows in one pass. Added to this, the tiler can be fitted with a ripper to break stubborn soil, a ridger and a fertilizer machine to prepare a furrow ready for planting and covering. Or, a complete mechanical planter can be attached behind the minimum tiller to fully mechanise the seedbed preparation and planting operations in one pass.

The advantages achieved by using the Elgin minimum tiller include

- Lishment costs are reduced dramatically.
- Soil erosion on slopes is minimized because less than 20 percent of the soil is loosened for the seedbed and the need for expensive contours is eliminated.
- The old crop stabilises the tractor on steep slopes.
- Delays in commencing planting due to heavy rains are eliminated because the tractor will always run on firm ground in field preparation and planting.
- The tilling obtained with the machine almost eliminates entirely the need for gap filling due to poor germination when using conventional equipment.

Elgin Agricultural Machinery have only been supplying equipment to the sugar industry for the past 18 months but they have outlets through tractor dealers and chemical suppliers in most sugar growing areas and if required, demonstrations of their minimum tiller can be arranged by dealers through contacting Elgin Agricultural Machinery at their Durban headquarters.

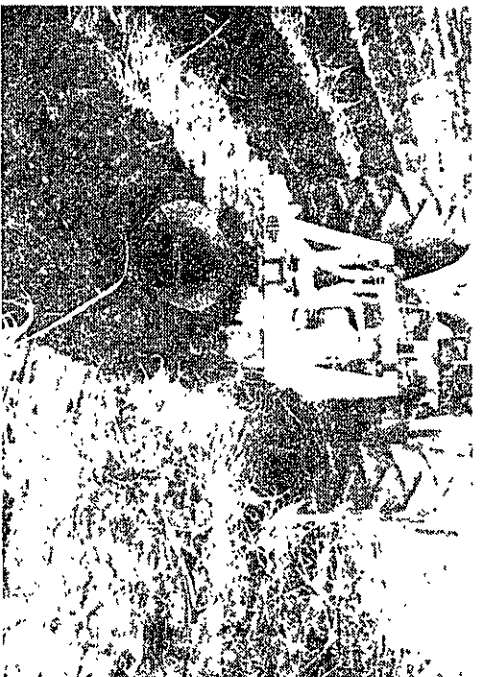

THE Elgin minimum tiller which will be on display at Sugarmech.

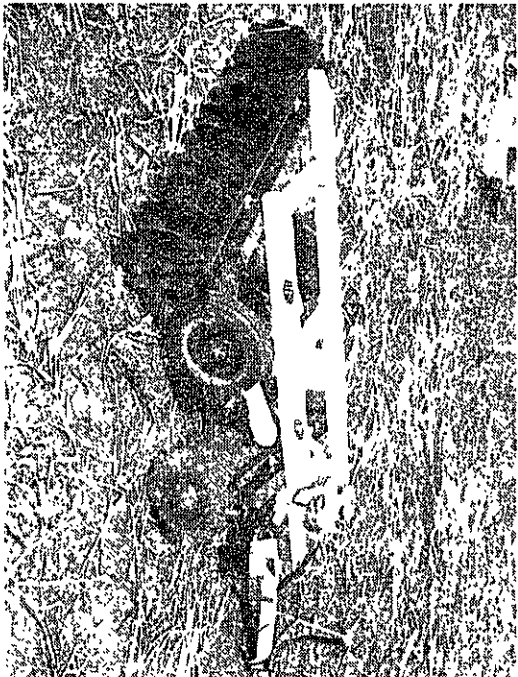

ALSO to be seen at Sugarmech will be this trailed offset disc harrow from Elgin.

**A D E
 duty
 ruling**

REPORTS have from time to time appeared in sections of the Press which may create the impression that diesel engines, other than Atlantis diesel engines (ADE), may be made locally for use in agricultural tractors.

Mr H H Beckurts, managing director of ADE, says this implies that such tractors, as in the case of tractors fitted with ADE engines, will be exempt from duty.

The Government's decision was that only tractors and commercial vehicles fitted with ADE engines will be exempt from duty and reports which could lead to any other conclusion are completely unfounded.

Such reports are viewed with concern by ADE's customers as they give rise to speculation in the market which may prejudice manufacturers who have given ADE their wholehearted support.

'I therefore wish to reiterate that the Atlantis Diesel Project was launched on the unequivocal decision by the Government that tractors and commercial vehicles will only be exempt from the protective duties to be imposed if they are fitted with engines within the power range manufactured by ADE,' he said.

'The motivation for this decision was to eliminate the disadvantages of excessive model ranges by approving the establishment of a single production facility only. Fragmentation of the market could only lead to increased costs.'

'I should also like to confirm that ADE is already in a position to provide engines from local production to those companies which have previously placed orders in anticipation of the introduction of protective duties on agricultural tractors on 1 October 1981,' concluded Mr Beckurts.

**Do-it-yourself fuel
 plan for sugar farmers**

IF FARMERS went over to using some of their own produce to produce fuel it

built for a reasonable price and be used to produce about 2,400 l of

small, farm-scale power plants. The company thinks the

about 15 percent. But such alcohol must be anhydrous — that is, have

national ethanol) distribution network. Vehicles would simply return to the

RONNIE MILLS
 TRAIL SERVICE
 100 RIBBAN 350 GALE STREET, PHONE 256431
 100 TERMARIBBURG, 197 GREYDING STREET, PHONE 21513



Do you have a financial problem?

The Standard Bank is able to provide a full range of services to help solve any financial problems you may have

- **Instant Credit Finance** for a car, caravan or pool
- **Standard Bank Card** to help control your budget and pay bills
- **Cheque Accounts** you can bank by mail
- **Savings Bank/Plusplan Accounts** interest calculated on daily balance.
- **Insurance** car, house and life assurance
- **Advice on Investments and financial planning.**

Call on our friendly staff at any Branch, they are geared to give you expert advice or to put you in touch with the many other financial specialists in the Standard Bank Group

We'd like to be your bank

Standard Bank

The Standard Bank of South Africa Limited

Head Office: 101, Market Street, Johannesburg
 5564-3871/2/3

● The old dead stool left in the field provides a mulch and retains natural moisture

● Mechanical re-estab-

crops to produce fuel. It would go a long way toward sorting out the diesel-petrol imbalance, because the agricultural sector uses 25 percent of the country's supply of diesel fuel

At present South Africa has too much petrol, and too little diesel, something inherent in the nature of the crude oil from which both fuels come.

This is the view of Mr Eric Buchanan, technical advisor to the South African Cane Growers' Association

But a vague and unsatisfactory situation about alternative fuels has prevailed for more than 18 months now. Broad and unclear incentives have been issued by the Minister of Minerals and Energy Affairs but no long term assurances about them have been given, and there has been a general assistance in entering the market," he says.

In Natal, of course, the interest would be very much in producing ethanol from sugarcane, and this has been shown to be possible on a small scale by Mr Don Hahnel, an independent consultant to the Brazilian sugar industry, the largest in the world. He recently published a blueprint for what he terms a micro distillery. Such a unit could be

produce about 2 400 l of ethanol a day, more than enough fuel to power machinery and vehicles on the average farm.

The company thinks the first commercial markets for the neat alcohol engine will probably be in Brazil or Zimbabwe, countries with active alcohol programmes

Such motors would be simple to operate and would create many job opportunities in rural areas. They would also bring about considerable fuel economies when compared to very large centralised ethanol distilleries, for there would be no need to transport the cane to the factory and then bring the fuel alcohol back from it.

Ethanol interest is now very widespread, with 40 countries around the world involved in one way and another with alcohol fuels, developing the technology for their production, doing research and development, or running test fleets. This is happening both in the developed countries and in Europe and America.

The Ford tractor division is now working on alcohol-fueled engines. First generation neat alcohol engines built by the company had been undergoing tests for more than a year.

The neat alcohol engine comes in two sizes - a three-cylinder 50hp model and a larger four-cylinder 70hp version. Apart from driving vehicles, the engines can also be used as

anhydrous - that is, have all the water removed, too complicated and expensive a step for a farmer to take. Hence the interest in engines that run solely on wet alcohol.

In Brazil Chrysler Motors has announced that it has made the first deliveries of alcohol-powered trucks to be used mainly in the transportation of agricultural crops, of sugarcane, for example, to the mills. It is hoped by 1985 to have a fleet of 120 000 trucks. No increases in sugar production have been necessary.

At Sugarmech

Also on test in Zimbabwe is a 100 percent alcohol powered Ford 6900. It has what was basically a diesel engine converted to alcohol and operates on the 98 percent hydrous variety. Two representatives of the company sponsoring the tests, Duly's of Salisbury, will be at Sugarmech with all details to date. One firm in America supplying agricultural machinery is already negotiating with Ford for the purchase of 100 tractors running on 185 proof ethanol. This form of neat alcohol consists of 98 percent alcohol and 4 percent water, which would be the neat alcohol produced by the Hahnel unit.

Small scale production of ethanol, he thinks, would be ideal for what he termed a 'captive' transport fleet. There would be no need for an elaborate

would simply return to the farm to fill up.

Modification of diesel engines to operate on ethanol fuel is a little more complicated than modifying a petrol engine. But diesel already has a high compression ratio by assisting ignition through a glow-plug or spark system the disadvantage of the low cetane rating of ethanol, and hence its inability to ignite spontaneously - is overcome.

He also said that it was feasible to retrofit diesel engines so that they could operate on neat alcohol.

This is being done at the University of Cape Town by Prof Dirk Dalkiewicz at the Agricultural Research Institute. So far, the source of expertise available to the agricultural sector if they moved in this direction.

It would in fact now make sense to re-evaluate all duties and levies on fuel produced from sugarcane, as a inducer for his own agricultural operations.

There is much local interest in alcohol production from sugarcane in Natal, he said. Several large and well diversified companies have expressed active interest in both fuel production and the necessary vehicle modifications.

CONTAINMENT DELIVERY PROBLEMS

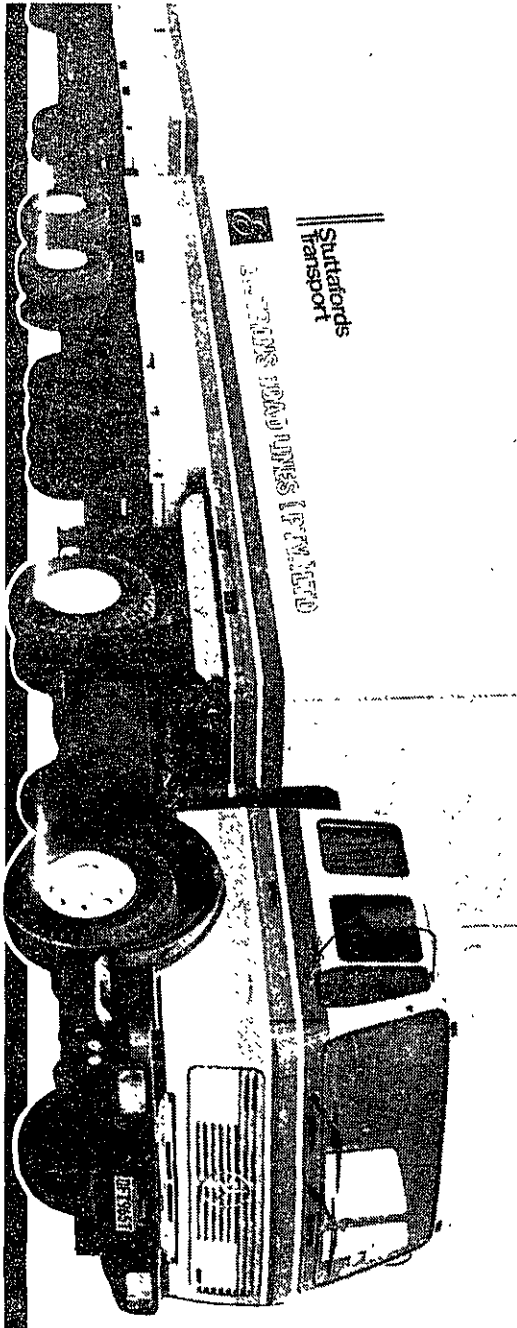

Stuttards Transport

377-3781 ROAD LINES (P.M.) LTD

WE UNDERTAKE ROAD TRANSPORT TO AND FROM THE REEF AREA. GUARANTEED SWIFT DELIVERIES WITH OVERNIGHT EXPRESS SERVICE IF REQUIRED.

SO GET MOVING WITH THE PROFESSIONALS!

DURBAN: 451558/9 TELEX 622190 • JOHANNESBURG: 345814/5 TELEX 89936 ALSO AVAILABLE: 60 TON, 43 TON & 35 TON RIGS

NOTHING STOP A NISSAN Serviced by Dalcem Truck & B 031 42603

NOTHING STOP A NISSAN Sold by Dalcem Truck & B 031 42603

MALCOMMESS, SOUTH AFRICA'S MOST DYNAMIC FARM MACHINE COMPANY, COMES TO NATAL.

*Always made a good vehicle!
Malcommess is doing business world
wide. Specialty
Line Specials Available. Available
Modeling has improved 1200 mph/mph
to improved cars.*

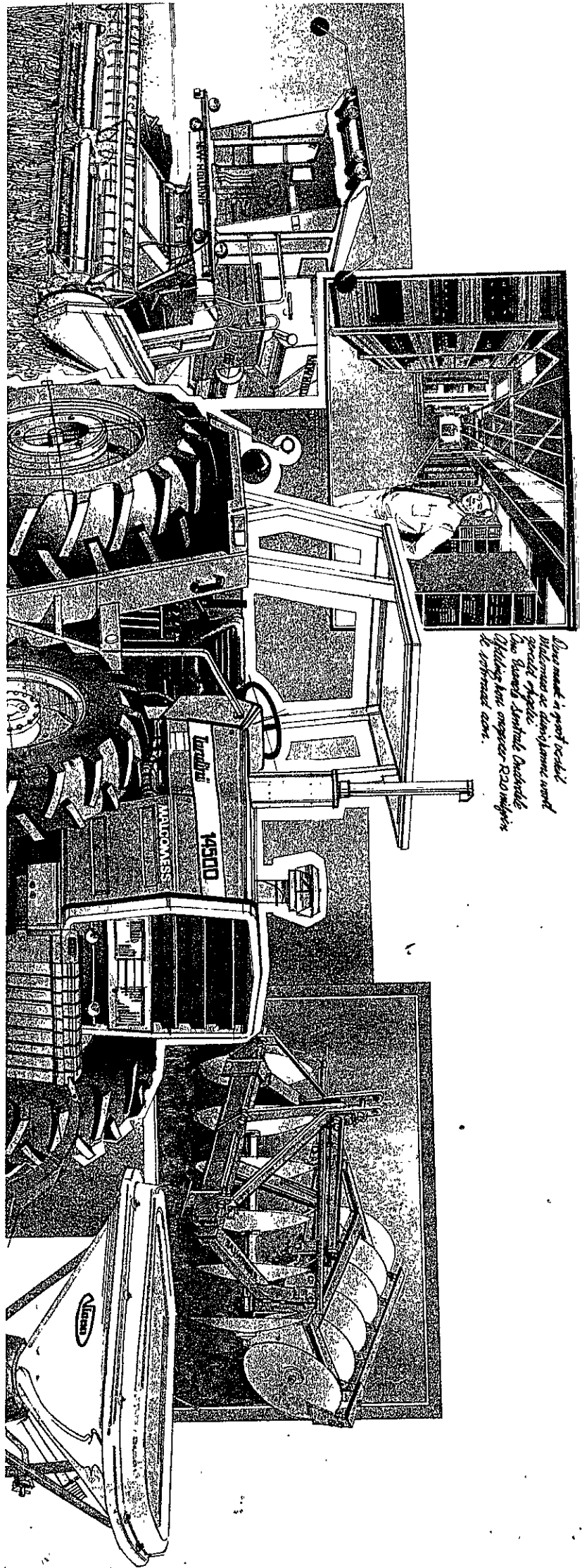

1950

Malcom's range of tractors, from the 3500 to the 10000, are available in 2000, 3500, 5000, 7500, 10000, 15000, 20000, 25000, 30000, 35000, 40000, 45000, 50000, 55000, 60000, 65000, 70000, 75000, 80000, 85000, 90000, 95000, 100000, 105000, 110000, 115000, 120000, 125000, 130000, 135000, 140000, 145000, 150000, 155000, 160000, 165000, 170000, 175000, 180000, 185000, 190000, 195000, 200000, 205000, 210000, 215000, 220000, 225000, 230000, 235000, 240000, 245000, 250000, 255000, 260000, 265000, 270000, 275000, 280000, 285000, 290000, 295000, 300000, 305000, 310000, 315000, 320000, 325000, 330000, 335000, 340000, 345000, 350000, 355000, 360000, 365000, 370000, 375000, 380000, 385000, 390000, 395000, 400000, 405000, 410000, 415000, 420000, 425000, 430000, 435000, 440000, 445000, 450000, 455000, 460000, 465000, 470000, 475000, 480000, 485000, 490000, 495000, 500000, 505000, 510000, 515000, 520000, 525000, 530000, 535000, 540000, 545000, 550000, 555000, 560000, 565000, 570000, 575000, 580000, 585000, 590000, 595000, 600000, 605000, 610000, 615000, 620000, 625000, 630000, 635000, 640000, 645000, 650000, 655000, 660000, 665000, 670000, 675000, 680000, 685000, 690000, 695000, 700000, 705000, 710000, 715000, 720000, 725000, 730000, 735000, 740000, 745000, 750000, 755000, 760000, 765000, 770000, 775000, 780000, 785000, 790000, 795000, 800000, 805000, 810000, 815000, 820000, 825000, 830000, 835000, 840000, 845000, 850000, 855000, 860000, 865000, 870000, 875000, 880000, 885000, 890000, 895000, 900000, 905000, 910000, 915000, 920000, 925000, 930000, 935000, 940000, 945000, 950000, 955000, 960000, 965000, 970000, 975000, 980000, 985000, 990000, 995000, 1000000.

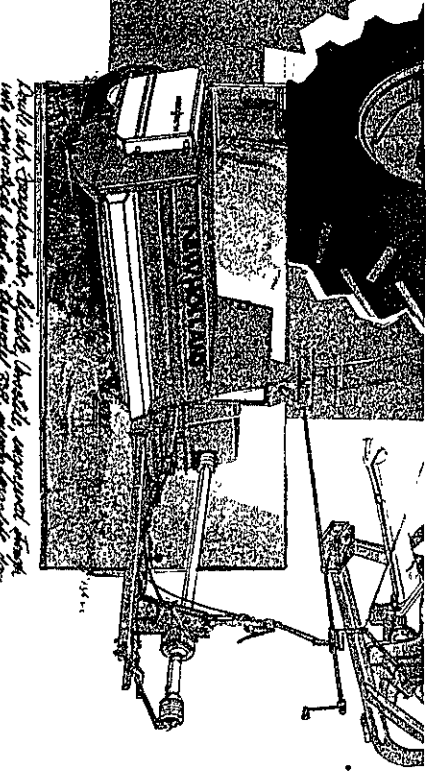
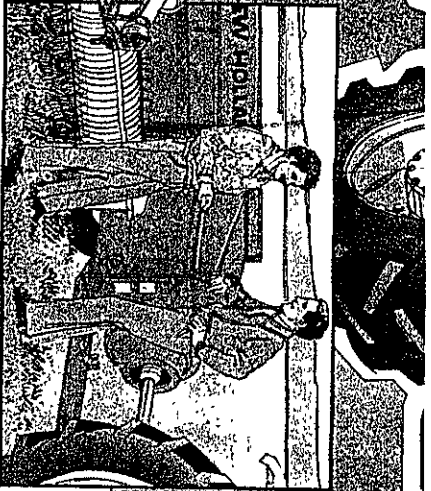
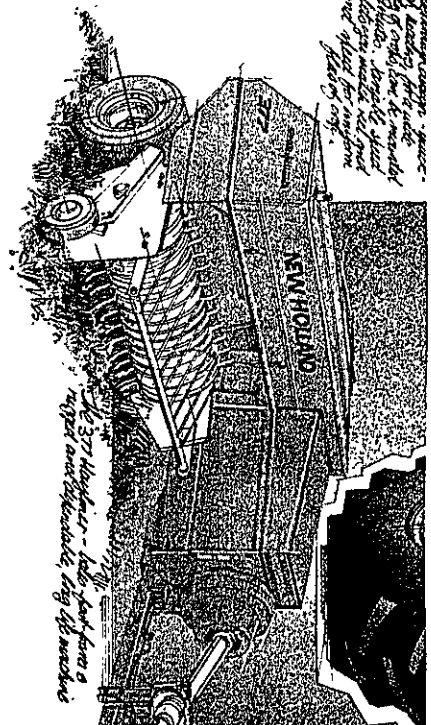

GREAT R5 000 000 EXPANSION BRINGS YOU THE WORLD'S FINEST FARM MACHINES PLUS SUPERIOR PARTS AND SERVICE BACKUP.

Here's all the high-performance farm machinery you need - no matter what size your farm. A complete range of the finest products from the world's big-name manufacturers. Selected and tested for South Africa's unique conditions. And proved, in the field, by our demanding farmers. But perhaps even more important, here's a company with a commitment to

excellence. A company that understands your needs - and promises performance. Malcom's has been spectacularly successful in recent years. We're aiming to become No. 1 in South Africa. And our Natal expansion is a vital step forward. Right now, our branch network is the biggest in the country. Our East London Assembly plant is almost doubling in size to handle increased

production and installation of the new A.D.E. diesel engines. Our Central Parts Department at Isando carries some R20m worth of stock. And our service teams are being continually enlarged and trained. Meet Malcom's soon. Come, grow with us. We really mean it when we say: Malcom's for your success.

**NOW OPEN IN
MURBATUBA
ESTOURT, NYUBATUBA.
AND PIETREBARTZBURG.
SOON IN GINGINDLOU
& DUNDEE.**

**SOUTH AFRICA'S
INDEPENDENT
FARM MACHINE
COMPANY.
IN OUR LAND
SINCE 1869.**



NEW HOLLAND, CANTON,
GERINGHOF, LANDINI,
HILLSTON, LAVERDA, VICON, KRONE,
BECKER, BRILLION, S.A. WONDER.

MALCOM'S FOR YOUR SUCCESS

MALCOM'S



INDUSTRIAL
MAINTENANCE
SERVICES (PTY) LTD.
INCORPORATING HUTCHINGS HYDRAULICS

HYDRAULICS

repair it all.

65656 391347

100 WILLIAMS ROAD, DURBAN

SUGARMECH '81

Expansion drive in Natal by top company

WHILE the business sector is generally adopting an attitude of caution, Malcolmss Limited, the farm machine arm of the Malbak Group, is launching a R5 million expansion drive in Natal.

Heading this programme is Zululand sugar farmer, Bryan Dingley who has been employed as Special Consultant. His intimate knowledge of the needs of the agricultural sector of the South African sugar industry and his personal contacts and past experience in the Natal agricultural scene gives the company the punch to speed up its search for success in the province.

This programme is a continuation of the expansion and development which has taken place in the other three provinces under the hand of dynamic managing director Robin Manning, who was brought in in 1979 after a successful stint as chief executive of Malbak Holdings. In 1979 Malcolmss showed a profit of R60 000 on a turnover of R31 million. By 1980 profit was up to R200 000 on a turnover of R39 million and the recent trading figures show a profit of R3.8 million on a turnover of R54 million.

How was this remarkable change possible?

Says Manning, 'All the potential was there. The people were there, the branches were there. But the company had been around a long time — since 1869, in fact — and we needed some changes. Attitudes mostly. We had

cent expansion). Senior executives were shuffled into new posts. Objectives were clearly defined. New appointments were made. New management techniques were introduced and new branches were opened.

But those were structural changes, says Manning, 'and while they made a huge difference, staff Marketing Director Frank Smit (who started work with the company as a mechanic in 1951) agrees that changed attitudes made the big impact. 'Look, we are exceptional in the industry in that we have branches. Our competitors concentrate on either both. But we have the strongest branch network in South Africa — around 40 already — and that says something. It says that we have a unique set of skills and resources to back them, because opening and maintaining branches is a costly and tricky business. But we've had those branches for a long time. What's new is the way they're functioning, the way they're serving the needs of our customers, the way they're attracting new customers. Our people are really busying themselves to do a great job now.'

From humble beginnings in a small King Williams Town workshop in 1869, Malcolmss was the brainchild of a young German immigrant, Hermann Malcolmss. Agenciers were found for a variety of overseas farming products and ever since the company has had strong links with the farming community. Over the years farmers' needs changed and a new concept in farming and in 1928 the company split its operations into two divisions. One, a motor division and the other an agricultural division which concentrated on farming machinery.

In the early 40s, Mr Fritz Malcolmss, a grandson of the founder, was appointed general manager of the farming division. Today, at the age of 69, he is the chairman of S.A. Wonder — a wholly owned subsidiary of Malcolmss which manufactures a wide range of implements of its own and others under licence in South Africa.

In 1969 Malcolmss was a founder company of the Malcolmss-Bakke (now Malbak) Group, under the chairmanship of Mr Dan Bernadé and was listed on the Johannesburg Stock Exchange. Turnover for the Malbak Group will exceed R200 million in 1981 and Malcolmss has played an important role on occasions as the largest contributor to Group profits with a growth rate of 102 percent over the past two years.

There has never been any doubt about the quality of the products Malcolmss brought to the South African market.

From the time of its conception in the days of Hermann Malcolmss, the company has paid meticulous attention to its products. Procurement director, August von Eckardtstein makes regular overseas trips to both keep abreast of latest developments in the agricultural field and to feed back to his principals the specialised requirements of local farmers.

'We're very fortunate in being independent of any single supplier,' says Von Eckardtstein. 'We buy combines from Claesson and Lavera, balers from Sperry New Holland, tractors from Landini, planters from Becker. In addition, we hold exclusive manufacturing licences from people such as Lilliston, for their Rolling Cultivator — one of the best tillage implements around. So we offer not just one range but the very best of many ranges. A complete system, in fact.'

Other suppliers in the Malcolmss stable include

Vicon, Krone, Geringhoff, Brillion and S.A. Wonder. All products except those of S.A. Wonder are imported in knocked-down or semi-knocked-down state and assembled in the company's East London assembly plant. The plant is currently being greatly expanded to keep pace with the company's rapid growth, and also to offer improved facilities for the inclusion of Alliantis diesel engines (ADE) for the Landini tractors which have been assembled for the past six years.

'We're in an exceptionally strong position with the engine change-over,' says Robin Manning, 'because there's really no difference at all for us. All that's happening is that our tractors will now arrive without engines, and we'll fit them here. But Landini have been fitted with Perkins diesel engines for the past 20 years, the identical engines to those that ADE are now starting to produce.'

'So we have no adaptation problems, no re-building or re-tooling at all. And, of course, we

the regional office.

With Same tractors, Bryan Dingley was the man who put four wheel drive tractors well and truly on the market in the low horsepower range (25 kW-66 kW) totally dominating the province of Natal and this concept has spread throughout the republic.

Dingley says that his thorough testing of Landini has convinced him that these are without question the finest tractors on the market today.

'Landini will outperform any other tractor available here,' he says. 'Consider the range — a total of 14 tractors from 35 kW Din to 99.5 kW Din, in both two and wheel drive.'

The main features which make the tractor distinctive from others are, apart from the Perkins engine, the high clearance, low centre of gravity, extended offset final drive — bringing the instrument cluster to the rear of the tractor — simple but efficient hydraulics and easy hand-adjusted three point linkage sensitivity which

ITALY'S RD TRACTOR PRICE



STAND NO. 5
AT SUGARMECH

SEE OUR DEMONSTRATION OF THE
FORD RANGE INCLUDING THE A.D.E.
TRATED AND APPROVED
ENGINE

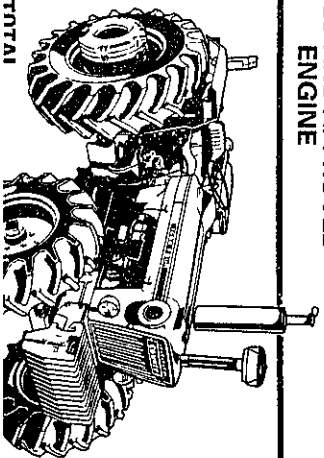

TITAI

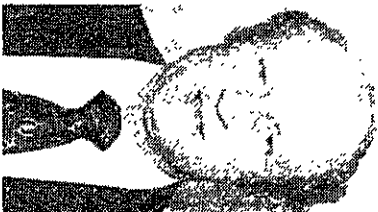

ZULULAND sugar farmer Mr Bryan Dingley is special consultant to Malcolmss.

the biggest difference was in the way our people began to see their responsibilities. I think I can honestly say that they all met the challenge fantastically well, and that today we have without any doubt, the best team of any company in the industry. Manning's enthusiasm has rubbed off on his

the biggest difference was in the way our people began to see their responsibilities. I think I can honestly say that they all met the challenge fantastically well, and that today we have without any doubt, the best team of any company in the industry. Manning's enthusiasm has rubbed off on his

the biggest difference was in the way our people began to see their responsibilities. I think I can honestly say that they all met the challenge fantastically well, and that today we have without any doubt, the best team of any company in the industry. Manning's enthusiasm has rubbed off on his

the biggest difference was in the way our people began to see their responsibilities. I think I can honestly say that they all met the challenge fantastically well, and that today we have without any doubt, the best team of any company in the industry. Manning's enthusiasm has rubbed off on his

the biggest difference was in the way our people began to see their responsibilities. I think I can honestly say that they all met the challenge fantastically well, and that today we have without any doubt, the best team of any company in the industry. Manning's enthusiasm has rubbed off on his

the biggest difference was in the way our people began to see their responsibilities. I think I can honestly say that they all met the challenge fantastically well, and that today we have without any doubt, the best team of any company in the industry. Manning's enthusiasm has rubbed off on his

the biggest difference was in the way our people began to see their responsibilities. I think I can honestly say that they all met the challenge fantastically well, and that today we have without any doubt, the best team of any company in the industry. Manning's enthusiasm has rubbed off on his

CALL ON:
ARMSTRONG MOTORS Pmt.
FRAZER & CHALMERS
 Durban — Also Port Shepstone
PERRY FORD
 Stanger, Umhlati, Eskhove, Muzini
RITCHE FORD Empangeni

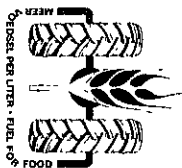

son compressor, 1.5 liter, we just weren't performing at anything like our potential.
 Manning was well known in the motor industry for his powerful, positive outlook and his exceptional motivating ability. This, coupled with the financial acumen of Mabhek M.D. and chairman of Malcomess, Grant Thomas, changed the face of Malcomess. During the past three years, staff was pruned from 900 to around 600 (it has grown again to just over 850 because of re-

DO IT RIGHT AND MAKE MONEY OUT OF FARMING

Tractor Hydraulic Kites fit all popular makes. Available for all hydraulic functions. You can get them ex stock from your local Co-op right now.

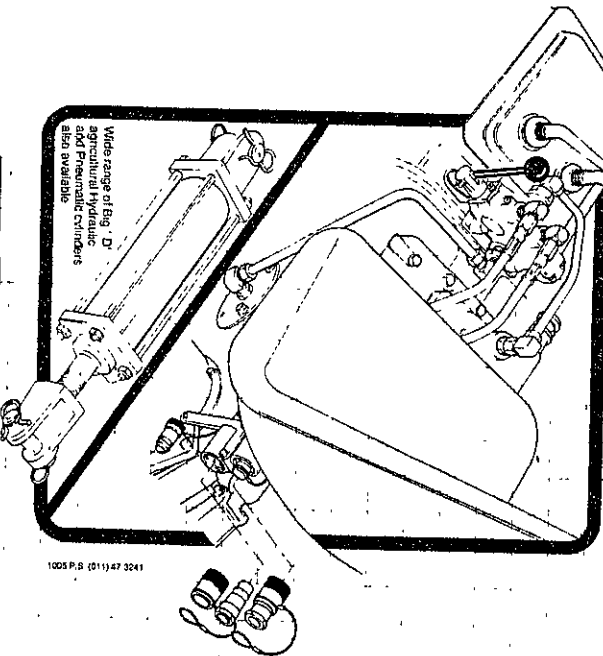

Wide range of Big 'D' Agricultural Hydraulic and Pneumatic cylinders also available

DURBAN HYDRAULICS

Trade enquiries
 DURBAN BRANCH (031) 35-0861
 CAPE TOWN (021) 97 1838
 DURBAN (031) 31-7195

EMPANGENI (031) 2-2301
 STANGER (031) 04-5480
 WITBANK (073) 2-5857

1005 P.B. (011) 47 3241

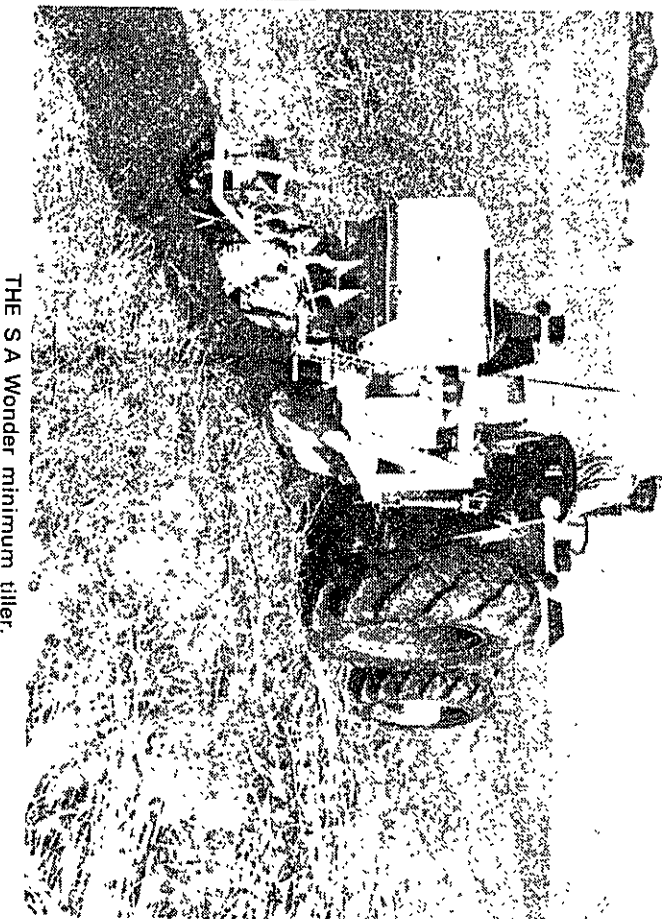

THE S A Wonder minimum tiller.

CANE GROWERS!

Elgin's NEW

COMPACT MINI TILLER

FOR ONE-PASS
 SEEDBED PREPARATION

ELGIN AGRICULTURAL MACHINERY (PTY) LTD.
 TELEPHONE (031) 257345/6/7/8

A Member of the Murray & Roberts Group

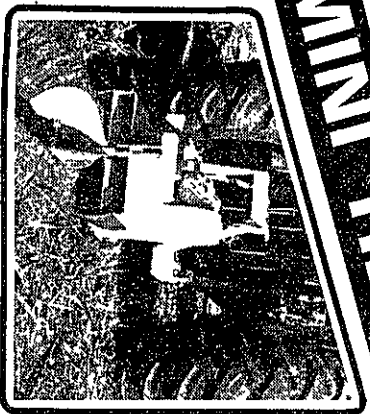

advantage that our service staff know the engines intimately, so we don't have to worry about re-training anyone. Nor do we envisage any parts problems. Even if there is an initial shortage from ADE while they build up stocks, we have huge stocks already.

Criticism

Until about a year ago, parts supply was one of Malcomess's weak points, and one for which it came into a great deal of criticism from farmers. But the company's restructuring of the Central Parts Department under Jim Truscott has since seen the parts supply rate jump to well over 90 percent — the highest in the industry, according to Truscott.

All branches now carry at least R250 000-worth of parts.

It's this determination to become truly effective in every area of its operation that makes Malcomess outstanding. And Natal farmers can expect excellent service from the new branches opening in the province.

The first branch has already opened in Mthathaba. Others are soon to follow in Gungahlovo and Dundee. There have been branches in Pietermaritzburg and Estcourt for some time, and Pietermaritzburg now becomes

flowing action, worst conditions.

Service

'Why did I offer to get in again with a venture this? Because I liked the spirit of the company, and I believe that Malcomess has both the price the people and the sales service back to do the job. It'll be to be associated in its operation in the future. Malcomess has everything it needs to be the first company in the first company to satisfy all the tractor implements needs agricultural sector sugar industry with own products.'

Dingley's right man in Natal is new

ported regional agent, Gus Ertel, recently transferred to the Western O.F.S. an extremely experienced farm equipment marketing man, at views his new post perhaps the most challenging and exciting of his career. The improved working conditions after three years there should prove to be that, for if ever there was an opportunity for a major farm equipment company to expand in Natal, this is surely

HYTEC & HYDRAULIC

PNEUMATIC SUPPLIES

TELEPHONE
 DBN 422236
 PMB 53413
 EMP 27306

101 RICHARD CARTE RD
 MOBENI, DURBAN

Millers seek dependable equipment

THE high cost of shutting down plant in the middle of operations leads sugar millers to seek out the simplest, most dependable equipment available.

Vacuum pumps — for condensers, evaporators, vacuum pans and filters — are an important item, as are compressors for carbonation and instrument air.

Some considerable advantages are claimed for those made by Sandcock Austral, licensed builder in South Africa for the Nash Engineering Company of the U.S.

Nash vacuum pumps, says Mr J H van der Walt, area manager in Natal for Sandcock-Austral, are come ported not side ported. They are built with metal cone sections that project inside the circle of the rotor blades along their inner edges. Open ports in the com-

porting, this happens so rapidly in most practical applications that the vacuum gauge will show only a momentary dip.

Larger flow passages in the cone ported pump and fewer sharp changes of direction in the flow paths reduce erosive wear so that Nash pumps give longer service.

Nash design allows the rotor to float when running. This minimises shaft deflection and in lengths bearing the In several other ways, Nash pump design provides extra strength, extra stiffness, and extra metal that contributes to long trouble-free service. They are rugged machines.

For these reasons, Nash pumps have been the preferred choice for more than 75 years for important wet vacuum applications.

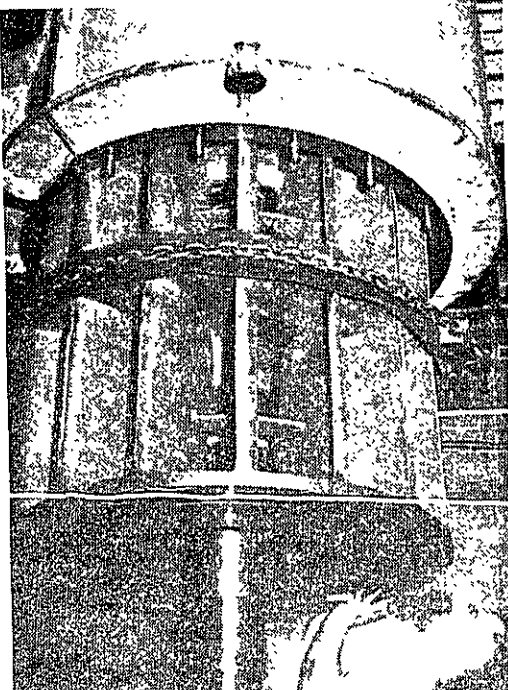

ONE of the Nash pumps, now being manufactured under licence in South Africa by Sandcock Austral

Cane stool eradication

A NUMBER of mechanical systems for eradicating sugarcane stools have recently been tested at the Sugar Association Experiment Station's La Meroy farm and also at the Central Field Station on the North Coast.

A renewed interest in such methods is due to the escalating cost of glyphosphate, first introduced in 1975 as a successful chemical method of getting rid of old sugarcane crop on all soil types.

The Experiment Station researchers point out that before planting a field to sugarcane, the stools of the previous crop should be destroyed to avoid the likelihood of regenerating shoots transmitting diseases such as ratoon stunt mosaic and leaf scald to the newly planted crop.

Early attempts by the Experiment Station to improve the efficiency of mechanical stool eradication involved the testing of mouldboard and disc ploughs, rotary hoes, rippers, potato lifters and groundnut diggers.

In the latest series of experiments, the use of a mouldboard plough followed within two weeks by a harrow or power harrow gave excellent results in eradicating sugarcane stools in a clay loam in the winter when

attached, leaving the old root system intact. The stools were inverted with the soil being treated effectively to desecration.

Fields with narrow row spacings will be completely ploughed and the likelihood of burying stools is greater but at wider row spacings only the cane row will be ploughed.

Ploughing to depths of less than 100 mm results in buds being missed which allows stools to regenerate.

When the soil is heavy and very dry it is difficult to penetrate and maintain a constant depth with the mouldboard plough, particularly when the entire field is not ploughed. The depth wheel can be replaced successfully by an inexpensive skid which can be fitted to all mouldboard ploughs.

A reversible mouldboard plough fitted with a depth control attachment should be used for shallow ploughing on hillsides where a one-way mouldboard plough is difficult to handle when turning the furrow slice uphill since there is insufficient mouldboard action to counteract the side thrust. After completely eradicating the old crop the field should be reworked to a depth of about 200 mm to prepare for a seedbed.

PERFECT PARTNERS

M&W DYNAMOMETER

TUXCO FUEL-RATOR

CALIBRATES DIESEL INJECTION PUMPS WITH ENGINE IN OPERATION

- PORTABLE
- ACCURATE
- EASY TO USE

- MODEL P40DM FOR TESTING UP TO 93KW (or 5407 mm, 735KW (or 1000 mm
- MODEL P200DM FOR TESTING UP TO 155KW (or 520 mm, 238KW (or 1000 mm
- MODEL P459 FOR TESTING UP TO 560KW

OPICO

SPECIALISED AGRICULTURAL EQUIPMENT

LOCAL OFFICE: 67 HIGHWAY HOUSE, 83 JAN SMUTS HIGHWAY, WESTRIDGE, DURBAN 4091

HEAD OFFICE: P.O. BOX 949, MOBILE, ALABAMA 36603 U.S.A.

Telephone: (031) 812826 • Telex: 622581 S.A. • P.O. Box 30116, Mayville 4058

SWIFT INDUSTRIAL SUPPLY CO. (PTY) LTD.

ARE HAPPY TO BE ASSOCIATED WITH SUGARMECH '81

DUNLOP INDUSTRIAL RUBBER PRODUCTS

- RUBBER HOSES • KANAFLEX • RUBBER SHEETING

Swiftex BATTERIES

FOR CARS, TRACTORS & TRUCKS

- TIMKEN ROLLER BEARINGS
- AND OTHER FAMOUS NAME BRANDS
- NORTON ABRASIVES
- BRISTAR THE NEW SAFE DEMOLITION AGENT

JOHAN DU PLESSIS
Sales Engineer
Nissan
NOTHING STOPS A NISSAN
Sold by
adjacent RUCK & BUS

SLEY PUSEY
est. Landon Executive Sales
Nissan
NOTHING STOPS A NISSAN
Backed by
adjacent RUCK & BUS
031 426037

ive Health
Sales Engineer
Nissan
NOTHING STOPS A NISSAN
Sold by
adjacent RUCK & BUS
031 426032

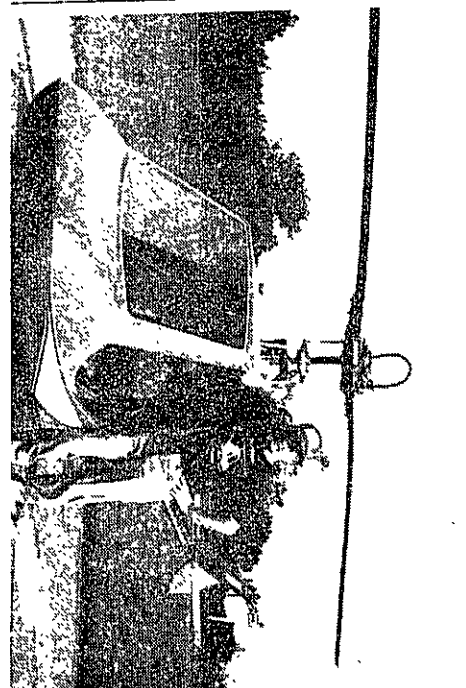

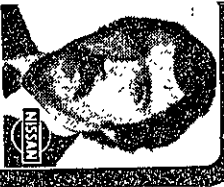

Alan Henderson
Sales Engineer

**NOTHING STOPS
ANISSAM**
Sold by
**Datcentre
TRUCK & BUS**
031 426032

MR Ken Hill, local agent for Rotor Flight Helicopters, with one of the machines which will be demonstrated at Sugarmech.

Build yourself a 'copter for fast travel

IT MAKES very good sense for anyone who's work involves a lot of regular travelling to consider buying a helicopter.

On show and being demonstrated at Sugarmech will be the built-it-yourself Scorpion helicopter. It costs £24,000, no more than the price of a fairly good quality car. Finance is available for up to four years on lease or hire purchase.

The cost of running a Scorpion is only a few cents more a kilometre than that

of motoring in a 2500 cc car but journey times are just a few minutes. It has a top speed of 200 km/h and can be flown directly to the destination instead of having to follow a road network.

When the full kit is purchased, basic flight training, which must be done within a year, is included in the price. It is also a condition of purchase that all builders attend a one-day pre-construction school in Johannesburg or Kriel.

Later on in the construction phase, there is a week-end seminar at which the owner will be taught how to build the blades. The seminar also covers final rigging and testing and how to run the rotor up to maximum revs and so achieve smooth safe operation of the helicopter.

Once the full licence is obtained, the owner can carry a passenger but it must be remembered that the Scorpion is registered in the ultra-light home-built category and so cannot be used for hire or reward.

the soil was dry. A shallow pass over the cane row at a depth of 100 mm with a mouldboard plough removed only the upper portion of the stool to which the buds were at-

to prepare for a second ploughing. The second ploughing buries the dry stools and leaves a clean surface for land smoothing and planting. Shallow ploughing fol-

with Egypt, approximately at a rate of 10 a hectare about six weeks after cutting and when the new straw crop is 450 mm tall. The new crop is planted in the old furrows.

• DINDIAN THE NEW SAFE DEMOLITION AGE WHICH BREAKS ROCKS WITHOUT DYNAMITE 174 GALE STREET, DURBAN. TELEPHONE 67747

John Deere



Farmers Services
For John Deere
BMW and Renault



**Sales, service and parts
Farmers Services**

**Umlhali: Salt Rock Road, Telephone: (032232) 23
Esthova: Osborne Road, Telephone: (035412) 861
Mthabatha: c/o Safari Motel, Telephone: (03552) 107**

Renault

If your schedule
says 'move it' -

HULTRANS

can take it!

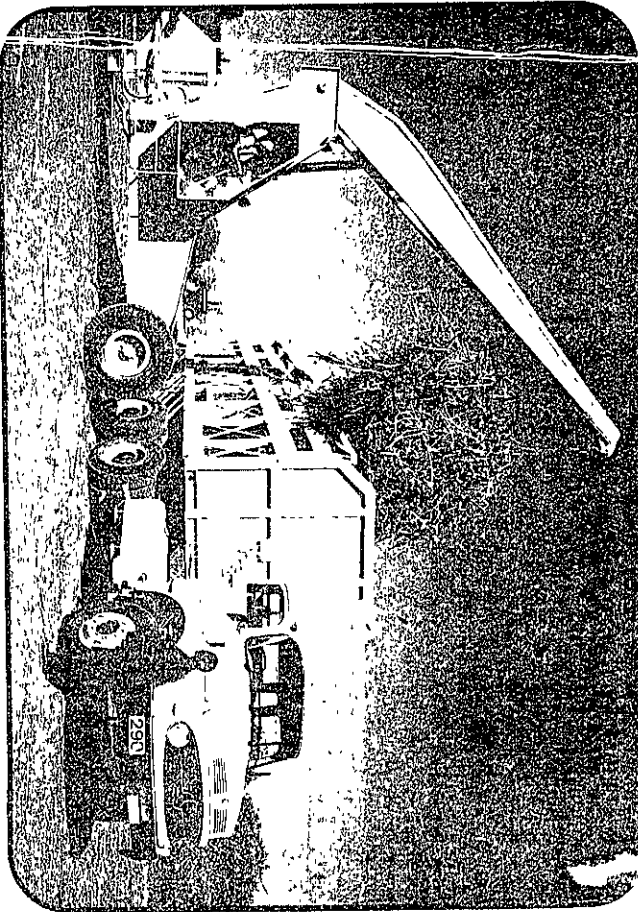

Hultrans
...the prime mover
in heavy haulage

Call Hultrans Reef (Airode) 8642070 or Durban 453141

A Member of The Hulets Group

We've got a **Good Reputation** to protect — **Yours**

AGRIIND PUMPS

- Your agricultural pump specialists
- Suppliers of pumps, pipe, valves and fittings
- Pump installations, repairs and maintenance



159 PALMER STR
TEL 031-329339
031-376445

Castrol

a famous name
in lubricants
serves the South African
Sugar and Farming Industry

Research keeps us in
the forefront



Castrol South Africa
(Pty.) Limited



THE three organisers of Sugarmech — (from left to right) Dr. G. de Beer, Mr. T. J. Murray, and Mr. E. Meyer.

Heavy duty vehicles on show

A RANGE of heavy-duty four tractors are the definite purpose of the exhibition at NMI's stand at this year's Sugarmech exhibition.

NMI is the Natal main distributor for Mercedes-Benz, whose range of vehicles are already highly popular with the sugar industry.

The ME Tractor series of tractors will be put through a 24-hour test during the exhibition. Showed in a variety of special features in sprayers, rollers and

gross vehicle mass category and some of the most popular models will be on display.

In the heavy-weight league, NMI will display the Mercedes 2628S32 model — a 6 x 4 truck tractor with a combined mass of 50 000 kg and 206 kW output, and the 2628S32 6 x 4 truck tractor which has a combined mass of 75 000 kg and output of 235 kW.

Also on show will be the full range of all-wheel drive agricultural and industrial multipurpose vehicles. The Tractor, MB-Trac

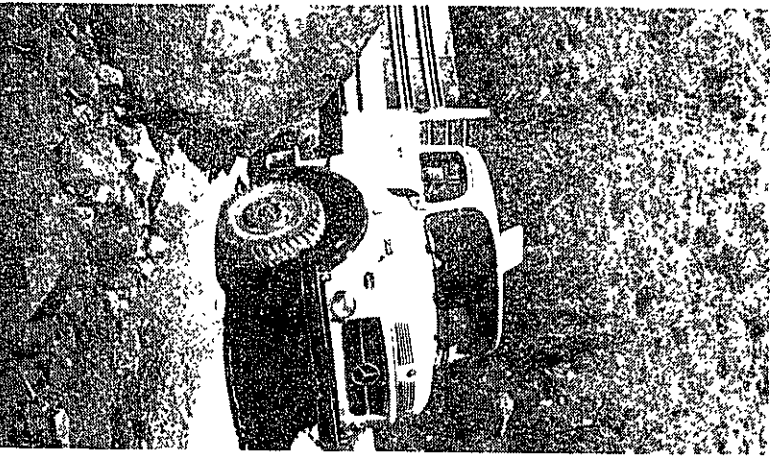

Organisers of

Sugarmech exhibition



FOR

NEW AND USED SPARES

- CATERPILLAR EQUIPMENT
- KOMATSU EQUIPMENT
- GM • DETROIT
- AND CUMMINS ENGINES

3 VALLEYVIEW ROAD
NEW GERMANY

Visit us at the SUGAR MECH.

METALTEK

(AFRICA) 1956 (PTY) LTD.

THE ORIGINAL COLD REPAIR PROCESS FOR FRACTURED OR BROKEN CASTINGS

CALL OUR ENGINEERS WHEN YOU NEED URGENT REPAIRS TO SUGAR MILL MACHINERY, ALL TYPES OF INDUSTRIAL MACHINERY, ENGINE BLOCKS, GEAR BOXES ETC.

METALTEK REPAIRS FEATURE

1. NO HEAT USED, NO DISTORTION
2. MINIMUM MACHINING AFTER REPAIRS
3. MINIMUM DISMANTLING
4. REPAIRS ON SITE
5. 24 HOUR SERVICE THROUGHOUT NATAL
6. ALL WORK GUARANTEED

WE ALSO OFFER HIGH TECHNOLOGY WELDING OF STAINLESS AND ALLOY STEELS
DURBAN BRANCH WORKSHOP

Mercedes-Benz is the South African market leader in the sale of trucks in the 3,000 kg

PUT SEVENTY-FIVE OF OUR TOUGH, HARD-WORKING HORSES TO WORK FOR YOU.

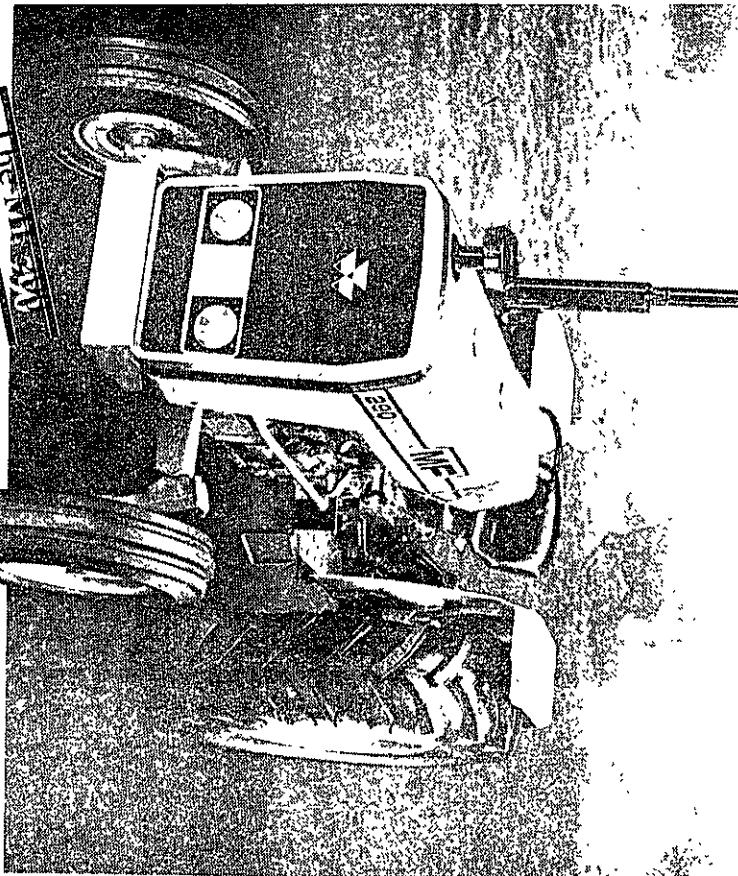

The MF 290 is one of the great 200 series from Massey Ferguson. With its power and price — it's the tractor that you've been waiting for. Powered by the legendary 52 CV Perkins engine, the MF 290 features all the things you've come to expect from Massey Ferguson: Durability, dependability, versatility and sheer good value for money.

Put together they add up to more efficiency and productivity. Which is why most people choose Massey Ferguson in the first place. When you'd like to see a demonstration of the MF 290 for you and see why we mean the MF 290 is the MF 290, call us today. The MF 290 is available in the MF 290 351 kW and the MF 290 352 kW.

MULTIPLE FARM EQUIPMENT PTY LTD
OLD MAIN ROAD, INDUSTRIAL AREA
STANGER, TEL. 23041

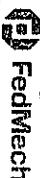

models are all fitted with Atlantis diesel engines. The capability of the cross-country model, the LA 1213 42 — is demonstrated by its daily trips from Natal to Lesotho across the gruelling Sani Pass road. The model is the standard unit for Mokhotlong Mountain Transport which runs the freight service across the pass and is the only heavy vehicle capable of making the journey over the de-purified and boulder-strewn road surface.

As for the sugar industry, Hulttrams alone has taken delivery of 19 Mercedes trucks in the past year. The first order was for 12 truck tractors (2628 and 2632 models) worth R700 000. This was followed up with an order for a further seven vehicles worth R400 000.

The latest trucks feature the Mercedes new generation cab and are powered by the Atlantis 407A diesel engine. Fuel economy and successful performance in working the previous year's sugar crop were the reasons behind the Hulttrams decision to expand its Mercedes-Benz 1213 cross-country truck in action on the Sani Pass road.

The Mercedes-Benz 1213 cross-country truck in action on the Sani Pass road.

MEMBER OF THE METALOCK INTERNATIONAL ASSOCIATION LTD.
BELFAST ROAD
BAYHEAD
DURBAN 4001
TELEPHONE: DURBAN WORKSHOP —
251511 (DAY & NIGHT)
AFTER HOURS: DURBAN BRANCH MANAGER —
423109 (HOME) TELEX: 6-20661 SA



AGRIPLAS WRIGHTRAIN

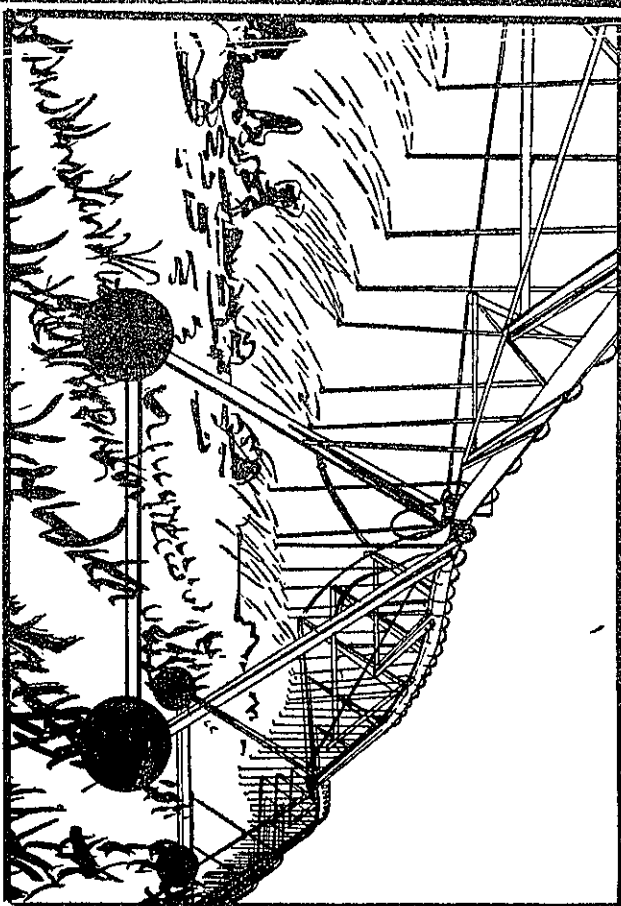

LEADERS IN PLANNED IRRIGATION
 ... whether five or 5 000 hectares we will design and engineer any IRRIGATION PROJECT on crop.

- Our applications include:
- CENTRE PIVOTS
 - BOOMS
 - DRIP & MICRO IRRIGATION
 - RAINMAKER TRAVELLING SPRINKLERS
 - PORTABLE SPRINKLER IRRIGATION
 - DRAGLINE & SEMI-PERMANENT IRRIGATION
 - TURF & GOLF COURSE SYSTEMS

AGRIPLAS WRIGHTRAIN

(EDMS) BPK/(PTY) LTD. NATAL
 TELEPHONES 72-8283/4/5 • PO BOX 256 • PINETOWN 3600
 TELEPHONE 72-8283/4/5 • POSBUS 256 • DEVONMEG 1 • PINETOWN 3600
 • TELD/TELENS 6-3065
 • D/REPOTS, TEL (0331) 41385-41072, 353 VICTORIA RD., PIETEMARITZBURG
 • P/NOIDA: (03842) 1312

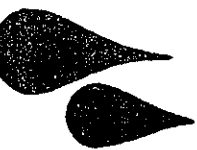

SEE US AT
STAND 90
 AT THE SHOW
 LA MERCY FARM

Sugar price

Financial Report

THE consumer price of sugar will not rise soon.

This assurance has been given by the South African Sugar Association after an apparent misunderstanding of a speech given by the association's chairman, Mr Ian Smeaton.

A spokesman for the association said Mr Smeaton had intended to convey that the industry had suffered a theoretical loss of R54-million because of the "peculiarities" of the formula on which pricing was based.

The current price of sugar had been based on a crop estimate of 2-million tons, but the crop had in fact been 1 640 000 tons. The loss was not real, but on the projected size of the crop.

This had unfortunately been interpreted as a real loss which would have to be recouped by a price rise.

The last sugar-price rise was in May.

2/1/80
38000

Award who has shown at the end

For the second best student in the subject of Building Construction.

C W von Düring

For the best student in the subject of Building Construction.

S A Brick Association Prizes

III: No award

II: A R Low Keen

I: N D G Sessions

For the best student in each of the courses of Building Economics I, II and III in the third, fourth & fifth years respectively.

LTA Prizes

P R Swift

For the student obtaining the highest marks in Professional Practice.

For the student obtaining the highest marks in

Surveyors' Prize

Cape Chapter of Quantity

The Committee of the Western

P C Key

For the best all-round student in any year of study.

Bell-John Prize

PLANNING
REGIONAL
URBAN &

(Continued)

QUANTITY
SURVEYING

RICHARDS BAY SUGAR Sweetening the area

After a relatively long period of inactivity, Richards Bay is re-staking its claim as the major growth centre of Natal.

Hot on the heels of Anglo's announcement that it is to spend R520m on a new pulp mill for Mondi at Richards Bay, Hulett's chairman, Chris Saunders, dropped word at the company's annual meeting last week that he intends going ahead with plans to build a new R110m sugar mill in the surrounding cane belt within 20 kms of the port.

The new mill, which will be the largest and most modern in Southern Africa, will have a crushing capacity of 600 t/hour. It will replace both the existing Felixton and Empangeni mills which are to be

retired. The move makes sense

As Saunders says, the older mills are only 16 kms apart and a single operation will result in "savings in cost and an increase in efficiency". The new mill will have a cane capacity of 3.3 Mt year compared with a 2.2 Mt combined capacity for the existing pair.

According to Dick Ridgway, Hulett's Sugar MD, the mill will be built in two, 300 t phases, the first coming on stream from April 1984.

"We intend to close the Empangeni mill in about February 1984 and direct the cane supply to the new mill. The second phase is scheduled to come into operation in 1985, when the Felixton mill will be closed."

Hulett's is hoping to absorb as many staff members as possible from the Felixton and Empangeni mills into its other milling operations.

In addition, where employees with lower levels of skill are involved, an attempt will be made to place them with some of the building contractors involved.

The decision to build a new mill boils down to a sensible rationalisation. But there are other strongly motivating factors — principally the developing potential of the black cane growers of KwaZulu.

Says Ridgway: "The project is designed to have both built-in spare capacity and facilities for easy expansion. Capacity will cope not only with increasing cane supplies from existing sources, but also from potential large-scale development of new cane land in KwaZulu.

"We will therefore be actively involved in the extension of cane growing activities in KwaZulu to the maximum extent," Ridgway observes. The sugar industry is able to accommodate this in its expansion plans and in its ability to market the resultant sugar.

disposition.

3.3. ENTERING AN

3.3.1. VDU Termi

Each character transmitted immediately after the end of the computer acknowledgement is sent back a <LF>; after which the system is ready for the next input line and prints a '>' to indicate this.

SUGAR

Subsidiary of Tate
and Lyle for Natal

Step 21/8/81
S. S. S. S.
By Colin Campbell,
Financial Correspondent

LONDON — Tate and Lyle's subsidiary, Tate and Lyle Agribusiness Limited — which advises on agricultural management projects in various countries — is opening a regional office in Durban.

The subsidiary has already played a role in the Simunye sugar project in Swaziland, and believes there are business opportunities in Natal.

The forte of Agribusiness is the provision of a "total package" in agricultural management — from a sugarmill, to arranging the finance, to training of staff.

Tate's other interest in Natal is 100 percent ownership of Pure Cane Molasses (Durban).

terminal is it is held in a log <CR>. The been reached by

Sometimes the signal to the computer is corrupted, causing a parity error. In that case the <LF> is followed by the message:

PARITY ERROR

the line must then be resubmitted.

If a mistake is made while entering a line (before <CR> is pressed) the line may be edited in one or two ways before it is operated on by the computer. If the line is to be deleted the line deletion key must be pressed (normally <CONTROL X>). This action is achieved by holding the <CONTROL> key down then typing 'X'. If characters are to be deleted the character deletion key: (on STN type terminals), <BACKSPACE>, or <CONTROL> and 'H', or <CONTROL> and 'Z' must be pressed once for each previous character to be erased. Examples of terminal runs using line editing are shown in chapter 6.

3.3.2. U100 Terminals

The method of correcting lines is different in that any string between the <SOE> character and the cursor can be sent to the computer. To do this there are four keys with arrows on them, indicating the direction in which they move the cursor, enabling the cursor to be positioned anywhere on the screen. Any character in a line can be changed by superimposing the cursor on the character to be changed and then typing in the correct character. The line can then be transmitted by moving the cursor to the end and pressing the transmit key. Additional characters and redundant characters in a string may be inserted or deleted before transmission by means of the <INSERT> and <DELETE> keys. If the <INSERT> button is pressed once, the right-hand part of the string starting at and including the character position where the cursor is situated will be shifted to the right by one space, thus making space for one additional character. If the <DELETE> key is pressed the character over which the cursor is situated will disappear and the right-hand side of the line will move one space to the left to close the gap.

Drought hits sugar crops

S Tribune
30/8/81
3 sup a

ON January 9 1852, the Natal Witness carried this report. "At Compensation there are 40 acres of sugar cane in luxuriant state which witnesses, who have been to Jamaica and Mauritius, pronounce to be equal to the produce of these two countries. Some 120 acres of additional cane are being planted."

This was the beginning of the sugar industry in Natal, and it was the work of a near genius by the name of Edmund Morewood.

Today in Natal, there are approximately 375 000 hectares of sugar cane which requires a work force of some 150 000 people.

In 1852, there was one mill, very primitive, built and worked by the same Edmund Morewood at Compensation. It produced a very limited quantity of sugar, but even in those early days there was an export trade. Today the mill at Compensation is a National Monument.

In Natal today there are 19 mills with another in the comparatively recently developed area of the Eastern Transvaal. These mills, on average, produce about 2 000 000 metric tons of sugar, of which one million is consumed in South Africa. The balance is exported. South Africa is among the top 10 world sugar producing nations.

In 1980 exports fell away because of a disastrous drought. The worst hit area was Zululand, especially at Amatikulu which showed 56 percent of mean rainfall.

The long term average came to 1,050mm. In the 1979/80 season this fell to 593mm. In addition production was vitally affected by the onslaught of the Eldana parasite

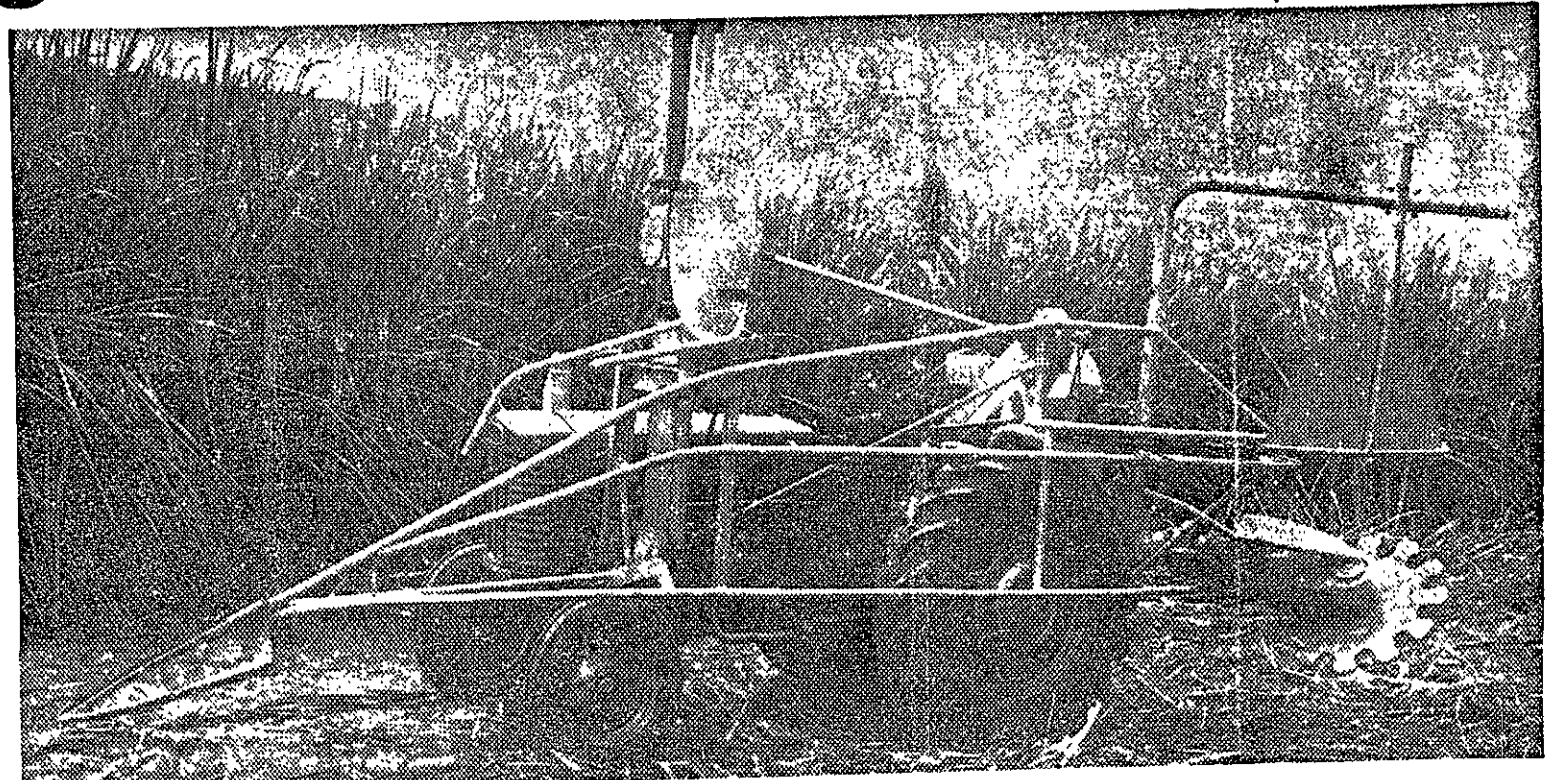

Harvesting sugar cane on the Natal North Coast

which attacked the cane at the roots, boring into them and causing tremendous losses to the industry. Once again it was the Amatikulu area which bore the brunt of the disease.

Strangely enough the South Coast canefields showed little sign of the borer but recently there have been indications that the parasite has reached the area.

Malelane, in the Eastern Transvaal, is the only cane growing area which has survived both the drought and the Eldana infestation.

To counter the Eldana disaster, the experimental station at Mount Edgecombe immediately went into full gear. Scientists were sent abroad to find out what could be done. All sorts of methods have been tried out but with very little success.

Because of the drought, exports were cut by approximately 43 percent and this was conservatively estimated to have cost the industry R25 million.

Today however there are signs that we are on the way to recovery and the latest indications are that we will only be short of the normal R2 million production by a very small margin. But the drought still persists in some areas and a great deal depends on the rainfall figures in the next few weeks if the estimates are to be reached.

One of the most interesting developments in the sugar industry is the spread of cane farming to the smaller man.

This has largely been accomplished by the efforts of the Small Cane Growers' Financial Aid Fund. The objectives of

the fund are to provide direct and indirect assistance to existing and prospective growers or groups of growers.

They come in the main from three classes, Zulus, with special reference to KwaZulu, Indians and Mangete growers. Not only is financial aid provided, but guidance, technical skills and knowledge are taught and provision is made to provide supervision and management both of which are essential to obtain maximum production.

In 1974 when the Fund began, R447,194 was advanced but by 1979/80 this figure had risen to R1 978 809 and some 13,338 hectares were under cultivation. The total cane delivered to the mills by these small growers amounted to 1 797 143 metric tons.

Here again drought took its toll, and Dr Geoff Cleasby, deputy group M.D. of Tongaat said: "The fruits of our latest developments in KwaZulu have been severely restricted by the drought. For Tongaat, along with the other companies, regards the growth of cane planting in KwaZulu as of primary importance and Tongaat, especially, treats this as not only an economic development but of great sociological importance.

The experimental station at Mount Edgecombe is one of the most important facets of the industry. They are on constant lookout for ways of improving production. Mechanisation is something else which is always on their minds especially when it comes to mechanical harvesters.

In Queensland Australia mechanical cutting is the rule of the game, but the topography is vastly different there from the hillsides of Natal. As one of the leaders of the industry put it. "It is better that we make haste slowly."

To introduce mechanical cutting might well reduce the labour required and by so doing, very large sociological problems could arise.

In addition, cane cut by the present type of machinery, has to be in the mill in six hours and even with modern transportation this is not always possible.

C. G. Smith are to spend a further R21 million on the Sezela plant alone. P. Coorsberg will add a further R14.5 million to their call for extensions and the other mills, too, are being carefully examined.

Sugar crop promise

2/9/81
2014
37200

EARLY spring rains in the cane-growing areas are expected to boost the next official estimate of the sugar crop to close to 2-million tons, up from last month's 1 940 000-ton forecast, says the general manager of the Cane Growers Association, Mr Ernie Morrison.

South Africa's 1980-81 drought-hit sugar crop totalled 1 610 000 tons against 1979-80's 2 080 000 tons.

Mr Morrison said Durban had had its wettest August in 100 years of records with about 250 mm of rain.

The Natal and Zululand sugar belt had not received as much rain as Durban had, but good rains had fallen in inland Natal. Zululand had its first spring rains over the weekend.

The next official estimate of the current crop will be available around mid-September.

SA sugar makes a success of futures

38WQW RDM 3/9/81

IN THE PAST decade the South African sugar industry has exported more than 9-million tons of sugar valued at more than R1 500 000-million.

The Sugar Association's export operations have been a success because it has an office in London which is in close contact with the major markets and which liaises continually with the Durban head office. Mr David Gass, who heads the London office, believes that commodity producers, from agricultural products to metals, should hedge at least part of their production. The association puts this theory into practice — and it works.

The Sugar Association makes more use of the futures markets than most other SA commodity producers and has had permission from the Reserve Bank to do so for years. Hedging is an insurance against price fluctuations. From a peak of £850 a ton in

THE SOUTH African Sugar Association has become SA's most sophisticated commodity exporter. In 1965 it opened a London office and it uses the futures exchanges extensively to protect itself from price fluctuations. In this second article on the advantages of futures markets, NEIL BEHRMANN tells how the Sugar Association uses London's United Terminal Sugar Market and the New York Sugar Exchange to its advantage.

1974, sugar slumped to a low of £85 in 1978 and then rose to £440 towards the end of last year. Since then the price has fallen all the way back to £179 a ton.

To offset these violent fluctuations, producers, consumers and sugar merchants hedge on the paper futures exchanges. On these exchanges paper contracts of sugar are traded against the purchases and sales of physical sugar.

The futures markets attract many speculators, especially when the price is rising. But true sugar traders — for example, producers and confectionery companies — deal on the paper market to offset their transactions on the physical market.

The South African Sugar Association can estimate quantities of sugar shipped to consuming countries. It also fixes the price on shipments depending on the market quotes at the time. But with prices fluctuating in an uncertain market it tends to hedge up to 50% of its production on the paper futures markets to insure itself against losses.

Take an example: a producing nation, like South Africa, contracts to sell a shipment of sugar to a consuming country, such as Japan, or a merchant in London or New York. The shipment is due next January. Say, the price of physical sugar is £200 a ton and the January price on the London futures market is £220.

The producer is satisfied with a price of £200 because there is more than sufficient profit. But it is worried that the price may fall. So it decides to hedge on the London Terminal Market by selling an equivalent amount of sugar for delivery in January. Thus January futures are sold for £220. By October the prices collapse to £180.

The producer has two options. It can cover the hedge by buying or closing the short sale on the futures market. Because the January price is around £195, the profit is £25.

In these circumstances the producer is speculating that the price will rise in the months to January. If it falls further the producer will not have a hedge to protect itself.

Alternatively the producer will decide not to speculate and protect its original position. It will allow the hedge to run until January. Say, the price falls to £170 by January. The producer then sells the sugar shipment to Japan at £170 — this is £30 lower than expectations at the beginning of September. But in January it will close out its hedge.

Because futures prices usually reflect an interest charge, which declines each month, the price on the January futures contract will be around £170, so the producer makes a £50 profit a ton on its short hedge on the futures exchange.

Say, the price soars to £260. Then the producer sells its sugar at £260 — £80 higher than the price at the beginning of September. But it covers in at

a loss of £40 on the futures market.

In this example the hedge transaction generates an extra profit of £20, making the effective sales price £220.

The opposite can occur as well, but the producer is basically trying to insure that it receives at least £200 for its sugar.

The example shows that there is no perfect hedge and for this reason the producer must be well informed about developments both on the physical market and futures exchanges.

But even though the Sugar Association must take a view, the hedging procedure is still a far better insurance than sales of sugar at unpredictable prices on the physical market — especially because commodity and currency markets are so volatile these days.

Because it is forward looking and progressive, the South African Sugar Association appreciates that it must have a sophisticated division in London, which also attends to international sugar politics.

Mr Gass estimates that the industry will export about 700 000 tons in the crop year which ends in April. About 50% of the sugar will go to Japan, 25% to Canada and most of the balance to the United States.

Throughout the year the sugar is shipped in bulk carriers which carry about 16 000 tons each. The association must be closely involved with short-term and long-term market developments.

Its office is at Sugar Quay, overlooking the Thames and Mr Gass, his deputy, Mr Athol Harley, and two dealers are constantly in touch with their brokers and customers. Television screens monitor price changes in New York and London and the team has an informed opinion on what is happening.

One of the dealers, Mr Charles Knowles, has been trading in the market for 25 years.

The London staff meet every day to discuss pricing of cargoes and hedging operations. They watch currency and freight rates and observe volatile interest rates.

To protect itself from currency fluctuations, the association hedges on the foreign exchange markets, especially as most of its sugar is quoted in sterling. A slight turn in sterling can have a significant effect on the association's earnings.

Mr Gass is interested in hedging financial futures when London's financial futures market opens next year. By hedging financial futures he would be able to insure the association against gyrating interest rates.

Mr Gass is aware that his team can be too close to the market. The team can get carried away by a spurt or a slump in price. So there is an open line to Durban and the association's general manager, Mr Peter Sale, and the export manager, Mr David Hardy, who was previously in London. They can put forward detached views.

On a combined decision the association can take a view on the market and go ahead with hedging techniques.

Mr Gass says that there is nothing wrong with hedging by selling futures on a rising market. In fact, it is advantageous to sell because there is sufficient volume. As long as the price is above the cost of production, the producer is assured of a profit.

He disagrees with mining house executives who claim that hedging is speculation.

"We accept the fact that sugar fluctuates and we hedge to limit our risk," he says.

SA

THE South African sugar industry will be cushioned from the slump in the sugar price because it has sold a large portion of its exports forward at higher values.

The London daily price of sugar has collapsed by 65% since November last year, while in New York quotations have slumped by 73%. Since August 18 the price has declined by more than 20% and is currently hovering between £150 and £160 — the lowest since December 1979.

Yet the South African Sugar Association insured itself against unfavourable price movements by hedging or selling forward on the futures markets in London and New York.

"A substantial portion of the current export crop has already been priced at levels which are above those prevailing in the market," says Peter Sale, general manager of the South African Sugar Association.

Mr Sale, who is on a visit to London, is not prepared to disclose the prices, but indepen-

dent sources believe that the sugar was sold at values in excess of £200 a ton.

So the association has thus guaranteed a sizeable slice of its export revenue at more attractive prices.

Some sugar analysts estimate that South Africa's crop will be around 2-million tons in the current season, which ends in April. This would compare with 1.61-million tons last year.

Yet Mr Sale says it is far too soon to talk of crop estimates, especially since the forecasts are merely based on rains over a single weekend.

Although heavy rains may increase the growth of cane, the sucrose content could decline, so that overall sugar production may not be up to expectations. But Mr Sale still expects this year's crop to be bigger than

last year's.

He believes that the total exportable production will be in the region of 650 000 tons to 700 000 tons, but that shipments will be in the region of 600 000 tons.

In the crop year ended April 1981, exportable production was 436 000 tons, but the association actually shipped 555 000 tons, as it sold excess stocks from the previous year's output.

The sugar industry however, will be adversely affected by the decline in price because values are much lower than last year and the association does not sell forward its full production. Mr Sale fears that after a brief hiccup, prices could slide again.

Sugar prices have fallen be-

SUGAR GOT ROUND S. Times 6/9/81 35000 PORTICE STIMPO

cause the European Economic Community's beet crop is expected to be substantial.

The EEC subsidises farmers, who effectively receive £320 for their sugar — more than 100% higher than world prices. The subsidy is financed by Common Market taxpayers.

Encouraged by a more buoyant sugar market last year, farmers sowed more sugar beets and because of excellent weather conditions the EEC will be producing a mammoth crop.

Brokers E D and F Man estimate that the EEC will be exporting an extra 2-million tons during the next 12 months.

To top it all, the EEC, which produces white sugar, refuses to be a member of the International Sugar Agreement. While poorer countries must cut their export quotas, the world mar-

ket is flooded with a glut of European white sugar.

Brokers estimate that sugar production will be in the region of 93.2-million tons in the 12 months ended August 1982 — about 7-million tons higher than last year.

E D and F Man reckons that consumption will be in the region of 91-million tons, but other sugar brokers are more cautious because the world recession has dampened the demand for sugar.

© See back page

Star 9/9/87

Gloomy season faces sugar men

38 mg

Own Correspondent
DURBAN — Sugar cane growers — facing the prospect of an improved crop this season — could be hit by lower export prices caused by a record world output.

The South African industry, plagued by a heavy debt burden, the aftermath of last season's drought and the depredations of the Eldana borer, could find itself facing pressure on its allowable return on capital.

In fact, said SA Cane Growers' Association general manager Mr Ernie Morrison, the industry's required proceeds could be affected if prices stay where they are.

But, says Sugar Association export manager Mr David Hardy: "The effect cannot be gauged so early in the season because a substantial tonnage of su-

gar has been sold forward on the market at prices well above current quotations.

"In other words, the effect of a world slide in prices could be neutralised."

Right now, prices are on the skids. Leading sugar dealers ED and F Man report that white sugar fell £70 in August alone

Writes ED and F Man: "There has perhaps been no time on record when the European beet crop has had more significance both on marketing, thinking and price evolution.

"By chance, a sharply expanded area sown to beets in the EEC has coincided with almost perfect growing weather and as a result the EEC is expecting what can only be described as a massive crop."

And because the EEC is not a member of the International Sugar Agree-

ment, Man predicts that the Common Market could seize more than one-third of all sugar movements during the season.

Mr Morrison said Africa's crop expectation had risen from last month's 1,94-million tons' forecast to nearer 2-million tons.

He did not expect difficulty to arise in marketing the excess.

In addition, the drought, combined with the growing season here, meant exports were running behind the quota.

ED and F Man added that the use of sugar substitutes and favourable crop conditions worldwide meant import levels were unlikely to rise significantly.

So, unless there was a severe deterioration in the weather during the harvest season, beginning within a couple of weeks and lasting until the end of the year, sugar producers look set for a depression.

UOST

86 84 82 80 58 56 54 52 50 48 46 44 42 40 38 36 34 32 30 28 26 24 22 20 18 16 14 12 10 8 6 4 2

Slumping prices
cut sugar quotas

Own Correspondent
DURBAN Slumping world sugar prices forced the International Sugar Organisation yesterday to cut the overall export quota to the world's free market by 15 percent — but the move is not expected to hurt South Africa.

tempt to force up prices. With world sugar output at a record level — a massive European beet crop gets most credit for this — prices have fallen drastically. They fell 70 a ton in August alone.

But, says South African Sugar Association General manager Mr Peter Sale, this country will not be affected by the new quota.

Because of the drought last season and the ravages of Eldana borer, South Africa is lagging behind its quota.

Last week the association's export manager, Mr David Hardy, said that because a substantial tonnage of South African sugar had been sold forward at prices well above current levels, the effect on the country of the world price drop would be somewhat neutralised.

The ISO's executive committee decided to cut the export quota for the 1981 calendar year to 13,86-million metric tons, down from 14,65-million set last May when quotas were introduced.

According to the rules of the 1977 International Sugar Agreement, the Organisation is pledged to make market moves to arrest prices if sugar slides to a minimum of 13 US cents a pound.

Such moves include withholding supplies from markets through imposition of quotas in an at-

Tax Planning	S.1 definition of 'South African Company', 'Republic', 'territory', 'definition of 'permanent establishment' in various DTA's;	Handout on U.K. Imputation System	T.1423 T.1430 8.9
Foreign Companies/	Company 'Republic', 'territory',	1294A, 864A, 193, 1637,	
Foreign Transactions	definition of 'permanent	Chapters 25, 25A,	
- S.W.A. Income	establishment' in various DTA's;	548J - K,	
- Walvis Bay Residents	ss. 28bis, 37A, 30, 31, 24B.	847B.	
- N.R.S.T.			
- N.R.T.I.			
- Foreign Exchange			
- U.K. Imputation System			

53, 28bis, 37A	1252 - 1294 1294A	Handout on s.50(d)	8.10 8.11 8.12
gross income' definition (GA), (k), (n); s.9, (w), s.22A(2), s.24A(3)	Chapter 7	-	10.4 10.6 T.1523
nd peruse double tax nts noted below with s on articles listed - Kingdom Art.1,3,4,6, 14,22.	Chapter 27 (skim)	Summarised table on D.T.A.	
states Art. IV, V, VI, VIII. Art.4,7,8,9,12,20. and Art.X, XI, XII, XIV,			

LECTURE DATE	LECTURE NO.	TOPIC	MEYEROWITZ	ILLUSTRATIVE EXAMPLES	TUTORIALS
10 August	17	Source			
		THE INCOME TAX ACT			

COURSE OUTLINE/READING LIST 3rd & 4th QUARTER
UNIVERSITY OF CAPE TOWN
DEPARTMENT OF ACCOUNTING
TAXATION AND ESTATE DUTY II - 1981

SUGAR (3) **SUGAR**
Bumper crop
 FM 11/9/81

An interesting new game among corporate officials in the sugar industry has been guessing the size of this season's sugar crop. The fact that the current season has been one of the most extraordinary on record doesn't make it any easier.

Earlier on, when the cane was standing withered and dry in the fields after a two-year drought, initial estimates put the crop size at 1.75 Mt.

Exceptionally good rains in April and March over most of the growing area threw out all those initial forecasts. Official estimates of the crop size were revised to 1.8 Mt.

Sugar men, even the old hands, have been amazed at how well the cane has come on since those first good rains. Further revision of the estimates now put the crop at 1.940 Mt -- but some optimists are predicting up to 2 Mt.

Dick Ridgway, Chairman of the Sugar Association and MD of Hulett's, says: "A lot of the mills opened late in the hope that the quality and quantity of cane would improve with an additional month's growth. So it looks like it's going to be a long, late season with crushing going on until the end of January and possibly early February at some mills."

Despite this revision, Ridgway believes that the current season is not a particularly good one. He says the industry, which has increased the cane area considerably since 1976, has been affected by years of drought and quota restrictions. It has yet to yield its full potential.

One advantage of the improved season's yield will be that it will help offset the losses suffered through prolonged drought and oldana bora infestations. Low export prices for sugar are causing some concern to the industry. If the situation doesn't improve, they are more likely to have a more marked bearing on next season's crop than the current one. This is because a lot of the sugar available for export has already been sold ahead or forward priced at levels well above currently quoted prices (R150 t at the time of going to press).

Ridgway says there is no danger of the

estimates a climate...
 costs, and find the best way out.

source of cure to the problem.

industry running into any deficits at current prices. And the bigger the final crop the bigger the surplus that is likely to flow back to the industry. "At this stage we expect to make a modest surplus over our requirements," he says.

However, he refuses to speculate on the size of the surplus. It will be interesting to see how the industry intends to use it, for it has had to borrow a total of R130m to help finance several poor seasons of droughts and quota cutbacks. The price stabilisation fund is all but depleted and any surplus could be a useful contribution to next year's season, which doesn't look that promising in the light of the world price slump.

It is early to make any firm assessments, but Ridgway expects world sugar prices to remain depressed for some time. With the exception of Cuba, there have been favourable crop conditions worldwide -- particularly in Europe where the EEC has sharply expanded the area grown to beets and has experienced near-perfect growing weather.

Ridgway believes that world prices are already beginning to react to an anticipated sugar surplus. If the low world prices continue into next season, it could have an adverse effect on the industry at a time when good summer rains have boosted crop expectations.

Durban experienced its wettest August

in 100 years. Good early Spring rains were also recorded over most of the Natal and Zululand sugar belt. Of course, soaking rains have to continue throughout the growing period, from October to April, for any anticipated bumper harvest to be realised. But, as Ridgway says, "at least the early rains have given a good kick off to next year's crop."

BENEFITS OF A SYS 10.6.1

It is quality control's response that is required, but whatever

- 4 SORT -
- 3 REVERSE
- 2 CHANGE
- 1 STUDY AI

These are:

At this stage four (4) alternatives

- 8 Improved employee morale.
- 7 Improved technical knowledge, more reliable engineering, development, and manufacturing design, and reliability of processes.
- 6 Lower cost designs of products and processes for a given sales volume, or greater volumes for improved attainable quality standards, with etc
- 5 Improved attainable quality standards, with etc
- 4 Reduction in costs of inspection.
- 3 Reduction in the cost of factors of production, uninterrupted production, and greater utilisation.

Hulett's expects mills to start up today

3 Sugar
10/81
Mercury Reporter

IN spite of a short work stoppage at the Hulett's Sugar Refinery in South Coast Road, Durban, yesterday, the management said last night that the Mount Edgecombe mill had restarted production and the other three mills at Felixton, Darnall and Amatikulu were expected to be operating by 7 a m today.

This followed a proposal by management to call a temporary moratorium and refund workers' pension contributions for September and halt contributions for October.

Group public relations manager Mr Ron Phillips said that about 1 100 workers had downed tools at the Hulett's Sugar Refinery yesterday morning, but were back at work by 2 p m.

Anxious

The stoppage appeared to be in sympathy with striking workers at the sugar mills, who were demanding immediate repayment of their pension fund contributions.

Workers were also anxious to find out how the situation would affect their pensions, Mr Phillips said.

After discussions with management the men had returned to work, he said.

Mr Phillips said representatives of the National Union of Sugar Manufacturers and Refining Employees reported proposals made by Hulett's management to workers yesterday following a sub-committee meeting of the industrial council on Tuesday.

Management had proposed to introduce a temporary moratorium while negotiations over the pension issue continued, and would refund worker's pension contributions for September and halt contributions for October, he said.

Three of the sugar mills have been shut down for a week. Felixton workers joined the strike at the weekend.

SUGAR ^{(3) sugar} Bitter-sweet future

Fm 16/10/81
Farmers hoping to break into lucrative sugar cane cropping are likely to be disappointed. The world oversupply and the low international sugar price give SA little hope of an increased quota when the signatories to the International Sugar Agreement (ISA) meet next month for the first round of negotiations.

The area under cane in SA can now yield up to 2,4 Mt in a good season — more than enough to supply the export as well as domestic market. The local market consumes 1,2 Mt and exports account for a further 1 Mt. Under the current agreement export quotas can be cut by up to 85%.

Addressing a symposium of the Durban Chamber of Commerce, Lawrence Gordon-Hughes, vice-chairman of the SA Cane Growers' Association, said pressure to expand cane-growing capacity came from a variety of areas stretching from the Transkei to the eastern Transvaal and Venda. Potential production was substantially more than the industry could market, especially as additional sugar had to be disposed of on the local market which had reached saturation point.

Says Hughes: "Because of the state of the world economy, competition from other

sweeteners, and over-production, particularly in the EEC, it is unlikely, in the absence of a major crop failure, that the world price will rise in 1982." ISA export restrictions are thus likely to remain.

Hughes adds that pre-shipping, stockpiling and exporting high-test molasses and animal feeds — both with a high sugar content but which do not count against the export quota — could help offset the problems of over-production. But there are limits to how far the industry can go.

He says he does not want to pre-empt the findings of a committee of enquiry currently examining the sugar industry. Personally, however, he feels that unless the production of ethanol from sugar cane is encouraged by government, large-scale expansion of the industry is unlikely at this stage. What the industry is seeking, says Hughes, is some degree of financial support from government, similar to the incentives enjoyed by Sasol, to make the production of ethanol more attractive.

Meanwhile, the industry is taking steps to ensure that its marketing operations remain as flexible as possible in the face of the highly changeable international scene.

Preliminary planning for additional bulk storage capacity has begun. This will allow the industry to stockpile more sugar. At present the three silos at Maydon Wharf provide maximum storage for 520 000 t. A fourth silo is being contemplated, but so far no decision on its location or whether to proceed has been taken. Depending on the structure, costs are likely to be in the region of R25m — more than the combined cost of the three existing storage facilities.

NM 3d/10/81

3-Sugar

Sugar crop outlook 'very good'

JOHANNESBURG — Prospects for South Africa's 1982/83, May to April, sugar crop look very good at this early stage, Cane Growers Association general manager Mr Ernie Morrison said.

Mr Morrison was echoed by Sugar Association general manager Mr Peter Sale, who told Reuters the weather over the past few

months in South Africa's main cane-growing areas had been favourable for next season's crop.

Mr Morrison said the crucial period for the coming crop would be between January and March, the hottest period when cane grows fastest.

September rainfall was well above average and this month excellent growing conditions had been experienced throughout the sugar belt, he added.

Zululand, which produces about 35 percent of the South African crop, had a particularly good September with rainfall 59 percent above average, Sugar Association statistics show.

Mr Sale said the Sugar Association has reversed last month's decision to stop temporarily releasing official monthly estimates of the domestic sugar crop.

He said the latest estimate puts 1981/82 output at slightly under 2,000,000 tons tel quel, sharply up from

1980/81's drought-hit output of 1,61m tons.

Projections of the 1981/82 crop have risen over the past few months in response to the favourable weather, and Mr Sale said there was likely to be a further moderate increase in future forecasts.

Mr Morrison noted that the current crop had the lowest sucrose content since 1934, when locusts ravaged the South African cane, due to a combination of last year's severe

drought and abundant late rains during this season's harvesting.

Mr Sale said it would take about 9.5 tons of cane to produce one ton of sugar this season against a normal average of about nine tons.

Mr Morrison said the eldana borer pest was a continuing problem for South African cane producers.

He said the industry was currently attempting to quantify crop damage at-

tributable to the eldana, and producers were cutting cane as quickly as possible to minimise its effects.

Meanwhile, Sugar Millers Association secretary Mr Ed Tough said most South African mills will close around Christmas, with the remainder closing in early February, reflecting a normal season.

Last year, sugar mills closed a month early because of a shortage of cane from the 1980/81 drought-hit crop. — (Reuters)

Weather augurs well for sugar crop

DOM 30/10/87
3 supa

PROSPECTS for South Africa's 1982-83 May to April sugar crop look good at this early stage, according to the general manager of the Cane Growers Association, Mr Ernie Morrison.

The general manager of the Sugar Association, Mr Peter Sale, says the weather over the past few months in the main cane areas has been favourable for next season's crop.

Mr Morrison says the crucial time for the crop will be between January and March, when cane grows fast at the height of summer.

September rainfall was well above average and this month excellent growing conditions have been experienced throughout the sugar belt, he says.

Zululand, which produces about 35% of the South African crop, had a particularly good September with rainfall 59% above average.

Mr Sale said the Sugar Association had reversed last month's decision to stop releasing official monthly estimates of the domestic sugar crop.

He said the latest estimate put 1981-82 output at slightly under 2-million tons (tel quel) against 1980-81's drought-hit 1 610 000 tons.

Projections for the 1981-82 crop have risen over the past few months in response to the favourable weather, and Mr Sale says there is likely to be a further moderate increase in forecasts.

Mr Morrison said, however, that the current crop had the lowest sucrose content since

1934 when locusts ravaged the cane. The reason for this year's low sucrose content is a combination of last year's severe drought and abundant late rains during this season's harvesting.

Mr Sale said it would take about 9.5 tons of cane to produce a ton of sugar this season against a normal average of about nine tons.

Mr Morrison said the eldana borer pest was a continuing problem cane growers.

He said the industry was trying to quantify crop damage attributable to the eldana and growers were cutting cane as quickly as possible to minimise its effects.

Cane growers face low sucrose levels

DURBAN — The general manager of the Cane Growers Association, Mr Ernie Morrison, says the industry is making a better recovery from the drought than expected, but is faced with the lowest sucrose return since 1934, when locusts destroyed the crops.

He said the extremely low sucrose level resulted from drought and late winter rains. Other serious problems facing farmers, was the Eidana borer pest and the low world price for sugar.

He said the association had sold enough cane in advance to insulate the industry against the price drop and there would even be a small surplus — but the prospect for 1982 was bleak.

Application for crop-loss loans to be repaid over seven years had been refused, and farmers had been told to complete their repayments by January 15 next year.

But the association had succeeded in getting the repayment date extended to January 1983. — Sapa.

AGRICULTURE — SUGAR

1982

JANUARY — DECEMBER.

Sweet music as Tonhul hit Top 10

22
3 Sugar

By MIKE PEIRSON
Finance Editor

IN his usual charming, cool, calm and collected manner the honourable gentleman of the sugar industry, Chris Saunders, made the historic announcement of the merger of sugar giants Tongaat and Hulett's at a late afternoon Press conference in Durban city centre this week.

Flanked by two indispensable lieutenants in retiring Tongaat managing director Alan Hankinson and new group financial director-to-be Ted Garner, Saunders was at pains to stress that this was a Natal-in-



Saunders . . . a Natal venture

spired venture. And so it was.

Anglo American? Yes, they had to be consulted after the merger talks had reached a conclusion, but they were happy to accept their 39.4 per cent holding in the new group.

Now the three pillars of Tongaat policy (food, shelter and clothes) will be consolidated with sister (?) company Hulett's (who will be taking the sugar kudos away from their Tongaat brothers) to distribute interests at all levels to the best advantage of all.

Certain areas, like Natal Estates, which could have been forced to close up shop will now get a new lease of life and, despite the soft talking that those responsible for the deal will have to do, with certain employees (particularly the Tongaat sugar men) it looks as though the new conglomerate will settle down to even greater diversified success.

The new group (to be known as Tonhul on

the JSE when listed) will have assets in excess of R1-billion and will rank among the country's top 10 companies.

The deal, worth R550-million, gives Tongaat an apparent edge on paper with 117 Hulett's ordinary shares being issue to 100 Tongaats. But that's just the way the arithmetic had to be done, explained Hankinson.

Final dividends for the financial year ended March 31 were fixed too. Tongaat intends paying 35 cents a share making 50 cents for the year while Hulett's final will be 46 cents (69 cents).

Of the new management team Dr Geoffrey Cleasby will be group managing director, Norman Duncan deputy and Ted Garner financial director

There'll be two vice-chairmen — Dr Kees van der Pohl and Walter Strachen. Dr van der Pohl will also be chairman of the renamed Hulett's Sugar.

Saunders who has been chairman of both groups in the past, will retain the combined position.

He feels that with the strong balance sheet of Hulett's matched with the dynamic management at Tongaat, the growth potential and opportunities will be considerable.

It was an encouraging sign that on the second day of trading on the JSE after the merger announcement, Tongaat shares stood at 1030c — up from 910c the previous day. That's the level we are likely to find the new Tonhul when it hits the boards on April 1.

Working effectively with black unions

DURBAN — Results in the giant C. G. Smith group are "very close" to budgets, the retiring chairman, Mr Mike Rosholt, said at the annual meeting in Durban. He indicated that the budgets had been drawn up "envisaging a slowing down in the exceptional rates of growth experienced over the past few years".

He said Mr Warren Clewlow, executive vice-chairman, had been appointed chairman.

Mr Rosholt said the group was "addressing itself to the developing black industrial relations scene and acknowledged that we, as employers, have to work for effective negotiations with the increasingly organised and competent black unions."

The nature of future retirement benefits was an issue for such negotiation.

He noted that the majority of black workers in the sugar division had withdrawn from the pension fund and he believed that this was not in their or their families' best interests.

Mr Rosholt said the expected fall-off in consumer spending on semi-durables had affected many of the Romatex product lines.

The Nampack results were better than expected and they intended to go ahead with a R35m glass container project.

For the sugar interests good spring and summer rains had fallen, which augured well for next season's crop, but the world sugar price was still a cause for concern.

Earnings up again

With the tax bill in the cement division down to nil, Blue Circle shrugged aside a much higher depreciation charge to end 1981 with earnings up 34% to 109c (1980 81.3c).

A final dividend of 27.5c has been declared making 38.5c (32c) for the year to December — a gain of 20%. Cover has been raised to 2.8 (2.5).

At the interim, earnings were ahead by only 17%, which means they leapt 41% in the second half.

Blue Circle revalued its assets by R35 700 000 last year and this lifted the depreciation charge no less than 59% to R10 800 000. In addition, the interest bill virtually doubled to R8 930 000 (R4 480 000).

As a result, pre-tax pro-

fit was actually down 11% to R25-million (R28 100 000).

But thanks to investment allowances on its new Lichtenburg cement kiln, Blue Circle Ltd, the cement division, paid no tax.

As a result, the group tax rate plummeted to 7.2% from 37.8% and taxed attributable profit was R22 900 000, a gain of 34%. Earnings rose in line.

Turnover was 23% better at R321-million.

Blue Circle chairman, Mr Trevor Coulson, said this was the 9th year in which the group increased earnings. He said the group had achieved an average annual compound earnings growth rate of 29.5% in the past nine years.

Textile jubilee

Moor River Textiles made a pre-tax profit of R5 190 000 in 1981 against R3 750 000 in 1980.

Tax was R1 260 000 (R1 200 000).

The final dividend has been raised from 30c to 75c to make a total of 105c (50c).

A special "jubilee" dividend of 150c has been declared. This special payment is said to mark the 25th anniversary of the Dutch-owned group.

Moor River has also announced that talks with another unnamed group on some kind of tie-up have been discontinued.

Earnings a share last year were 231.5c (150.1c).

The group is proposing a four-to-one share split with the 1 700 000 ordinaries being enlarged to 6 800 000.

The rise in earnings last year was 54%.

Turnover was R19 680 000 (R16 370 000).

Colliery profit

ANGLO-Transvaal Collieries raised its taxed profit by 32.4% in the six months ended December 31, to R2 251 000 from R1 700 000 equivalent to 133.1c (100.3c) a share.

Dividends on AT Colls fixed investment in Witbank Colliery rose to R2 258 000 from R1 720 000, while other income rose to R20 000 from R6 000 and expenditure fell to R19 000 from R24 000.

The market value of the company's listed investments at December 31 was R76 349 000 compared with R69 897 000 at the end of

1980, while the book value on both dates was R3 256 000.

Platinum projects

RUSTENBURG Platinum Holdings plans to spend a total of R40-million on capital projects in the year to August 31, said the chairman, Mr Gordon Waddell.

He told shareholders at the annual meeting in Johannesburg that R14-million would be spent this year on expansion and a further R26-million on the maintenance of capacity.

The R46 700 000 allocated for expansion at Rustenburg would be incurred in due course to meet the additional metal requirements arising from the company's various new contracts with the automobile industry.

Mr Waddell said further applications of platinum catalysts were being developed in the chemical and petroleum industries, in an attempt to increase efficiency and reduce energy requirements.

In the past year substantial progress had been made in developing a platinum catalyst for controlling emissions from diesel engines.

This technology was being developed primarily to meet proposed United States legislation, but also had application in specialised uses of diesel engines, such as underground locomotives.

A further extension of the use of catalysts on cars could occur in Europe after 1986, said Mr Waddell.

Developments in the glass industry were likely to extend the applications of platinum metals and result in increased use, said Mr Waddell.

Fuel cells were unlikely to be produced on a large scale during the next five years, but "as and when fuel cells prove to be competitive with alternative methods of power generation, demand for platinum for this use could become significant."

Working loss continues

An increase in tonnage and an associated drop in working costs were not enough to turn Witwatersrand Nigel's fortunes around in the December quarter, and the taxed loss was R466 283 compared with R487 081 in the previous quarter.

The State-assisted mine milled 82 598 tons of ore during the quarter compared with 76 142 tons in the September period, raising gold production to 295.2 kg from 274.5 kg in spite of a fall in average grade to 3.57 g/t from 3.60 g/t.

The directors say, the working loss before sundry revenue rose to R520 761 from R510 603, while sundry revenue was unchanged at R39 000 and there was a tax credit of R15 478.

Capital expenditure, which has been limited to essential projects, fell to R464 351 from R690 075, but the average rate for the past two quarters is expected to continue for the next two.

Wit Nigel received R450 000 in State aid during the December quarter, which reduces the net loss for the period to R16 283.

Analysing the first half performance, the directors point to the R14 341 a kg gold price required to cover working costs; and capital expenditure under State aid conditions, against the actual R13 057 a kg received in the six months to December.

Without State assistance Wit Nigel required an average gold price of R17 034 a kg or \$530 an ounce to break even.

Best year on record

The best year on record for Goodyear South Africa, was 1981 thanks to buoyant economic conditions, a record year for motor manufacturers and a steady demand for industrial rubber products. And, although the motor industry expects a tail-off this year, Goodyear can expect another excellent 12-month period.

This is the view of the company's managing director, Mr W. F. Life.

He said all sectors of the motor industry — passenger car, light and heavy duty truck and tractor — reported record sales in 1981 and this naturally and a spin-off on the tyre and rubber industry.

"What we must not lose sight of is the fact that the excellent sales over the past two years — more than 856 000 units — augurs well for the replacement market," said Mr Life.

Turning to the mining industry, Mr Life said some operations had been cut back because of economic recessions in other countries.

The major exception was the coal mining industry, which had shown rapid expansion which was likely to continue through 1982.

"Within these mines, Goodyear has found an excellent market for its range of conveyor belt- ing," he said.

Flexing regional muscle

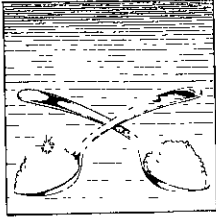

The birth of the Tongaat-Hulett's group could have far wider implications than the rationalisation of the sugar industry. Potentially, it should be capable of considerable political influence, especially in Natal's regional affairs, as well as having substantial business muscle.

Chairman Chris Saunders is unlikely to be slow in using this leverage in both spheres for what he believes to be Natal's — and ultimately SA's — best advantage.

With assets of R1 billion, Tongaat-Hulett's is one of the country's industrial giants — and another that has a close association with the Anglo American Corporation. It is about the size of SA Breweries or Rembrandt.

It dominates the sugar industry, but also has substantial interests in building materials, textiles and food. Yet it is centred predominantly in Natal, a richly-endowed province that has historically placed a high premium on its own individuality.

Saunders has long held the view that Natal has a special role to play in the development of SA. Its significance lies partly in its demographic composition. Natal is one of the most densely populated regions of the country — containing roughly 20% of the country's inhabitants. Of those more than 78% are either black, Asian or coloured.

Geographically, moreover, the province has a favourable climate, an equitable distribution of rainfall and an abundance of cheap sources of power. In addition, it has a well-developed transportation network, two deep water harbours and a long tradition of orderly local government. A further advantage is that it is surrounded by parts of SA — or independent states — which offer a substantial market. "All that is needed," says Saunders, "is for the ingredients to be ignited so that it can take off."

But an economic surge ahead is partly dependent on developments on the political front, where progress is slow and difficult. As Saunders points out, Natal has a history of rejecting political solutions a-la Pretoria. But there is a chance that the power-sharing philosophies of the Buthe/Lezi Commission must find more mutual acceptance.

Saunders believes the next few decades will be crucial for Natal. "They will determine whether we will be mixed, capitalist and free, or mixed, Marxist and dominated." Rather than wait for some other torch bearer, Saunders believes that industrialists should take the initiative and forge ahead with a new economic federalism of

their own, which would turn the region into an economic powerhouse or the "Ruhr" of the African subcontinent. Political progress would not then lag far behind.

Mobilising the R1 billion assets of the Tongaat-Hulett's group will be Saunders' first step in achieving this economic federation. He believes that if the country's economic order is not to be swept aside by the advance of Marxism, then the country — and Natal in particular — will have to grow at a far greater rate than the current 5%. According to Saunders, the combined resources of the two groups should allow Tongaat-Hulett's to grow at a rate of between 8% and 10% a year.

But in order to encourage a higher growth rate, says Saunders, there must be a move away from labour intensive, low skills production to high technology, high skills production. This will mean that industrialists will have to take more positive action in raising the educational standards and improving the skills of their employees.

"We have got to move on a completely new economic path," says Saunders. "Productivity is the key to progress. Ultimately we will have to go the path of Japan." Saunders' vision of the future is one in which workers offer loyalty and commitment to the company virtually on a life-

long contract. In return, they are rewarded by a commitment from the company and a tangible demonstration that the company is prepared to invest in their welfare.

"You have to get the worker to identify with the company. If the company does well then it should follow that he will do well." Like most supply-side economists, Saunders believes that industrialists should be given the opportunity to create wealth. And having created it, he sees that they have a commitment to redirecting a portion of it back to the people who helped create it, especially if it is to be preserved or further extended.

The sugar sector is likely to be the first to feel the impact of Saunders' "new deal." Not only is agriculture the quickest and easiest way to provide employment for people, the merged sugar interests of the two constituents will be the biggest operating arm of the group. The plan is to extend the group's cane growing activity into parts of Kwazulu to enable more black farmers to participate in the cultivation of a lucrative cash crop.

In some respects the decision makes good economic sense. Kwazulu is one of the most economic cane-growing areas in relation to transport to the mills. A small start has already been made in this direction. But one problem is that the industry's production is bound into a quota system until there is a rise in world sugar prices.

There are likely to be major rationalisations in joint sugar interests as a result of the merger. For example, the refining operation, formerly under Hulett's control, will now be more accessible; fleet transport will be rationalised and there will be greater utilisation of milling capacity. Says Saunders: "The industry has a considerable opportunity to improve its productivity. I believe that over a period of time we could contain our costs and combat inflation, which is one of the industry's major problems."

In addition, the sugar sector is poised for growth for the first time in five years. According to Saunders, Tongaat had recently diversified out of sugar and Hulett's, with 36% of the country's output, was using nearly all its resources to maintain market share. The combined production of the new group will now be around 43% of the total — the country's largest. The structure of the new group will give Saunders ample opportunity to extend his new economic strategies to other sectors.

The remainder of the group's activities are largely centred around the provision of food, clothing and shelter — all of which are highly labour intensive. Growth in these sectors should be steady, if undramatic. Certainly no further diversifications are being planned. Says Saunders:



"I see very little prospect of expanding outside the areas that we have identified."

Of course, some will argue that the merger of Tongaat and Hulett's has been inevitable since 1980, when Barlows moved into the C G Smith group.

At that time Barlows acquired 50% of S & T investments — an unlisted company which held slightly more than half the equity in Hulett's — through its takeover of C G Smith. Tongaat, which was controlled by Anglo, held the other 50% of S & T.

The mere fact that such an arrangement existed is some indication of the degree of empathy between the two groups, although it is rumoured that Barlows was the more uneasy partner of the two. Nonetheless, with C G Smith's interests accounting for roughly 40% of the total output and Hulett's approximately 30%, control of the major portion of the country's sugar industry seemed within Barlows' reach.

A further complication was that should a disagreement over Hulett's development have arisen, both Barlows and Anglo (through Tongaat) could effectively have applied blocking devices. In August 1980, Barlows backed away from this potential deadlock position by selling its half of S & T to Anglo for R97,6m. The other main element in the complex deal was the sale to C G Smith of Hulett's packaging interests, Hypack and Containem, which were later merged with Nampak.

Although Barlows failed to get Hulett's Aluminium — which it undoubtedly wanted — it came out of the deal fairly well. Nevertheless, the reasons for the "retreat" were never fully explained. At the time, however, Barlows' chairman Mike Rosholt said it would have been "unacceptable" for one company to control 70% of the sugar industry, as would have been the case had Hulett's been absorbed into Barlows.

Having gained control of Hulett's, the next logical move for Anglo was to merge its sugar interests in both Tongaat and Hulett's. The only surprising element in last week's merger is that Hulett's and not the much larger Tongaat was chosen as the vehicle.

Between them Anglo and Barlows now control 80% of the country's sugar output. But the important thing is that neither is dominant and they are both ranged against one another rather than participating as associates or partners. This must be good for competition, even though it may be covert.

What is interesting, moreover, is that although Barlow's business is spread over the country, its roots are in Natal. That fact, placed alongside Saunders' obvious ambitions for Natal, could also have a profound impact on the province's future development. It will have two heavy weights rooting for it.

Graham Fiford and Chris Wilson

academic interest. A lot will depend on export shortfalls (over 1.5Mt in the previous year) but at present the outlook remains overcast — reflected by a London daily price in the doldrums of the £160-180/t range.

Under the international sugar agreement formula, basic export tonnages (BETs) are calculated on the best two of the previous three years. The total BET for the exporting countries for 1982 is thus put at 19.44Mt (up 9.2% on 1981). And SA's allocation, in spite of last year's drought-blighted exports of 704 000 t, moves up by 6.7% to 1.03Mt.

With world prices at the bottom end of the ISO floor, export quota cuts of the maximum 15% automatically apply. So the effective total export quota is 16.5Mt (against 15.15Mt) and SA's share is 878 000 t.

This compares, however, with the ISO's estimate of the size of the world export market after allowing for sales by non-ISA groups, such as the EEC. That works out at 12.9Mt — for even though the EEC has announced it will stockpile at least 1.7Mt, and

Consumption is put at 91Mt-95.5Mt.

Sugar futures prices, which had steadied in early February on news of the EEC's plans to stockpile at least 1.7Mt as well as strong Soviet buying, have since faded. The Russians appear to have liquidated their forward raw positions and switched to buying refined whites.

In addition, the market has been depressed by the size of the potential overhang. To the EEC's stockpile must be added the 1Mt, which ISA exporters will be piling up under the agreement's special arrangements this year (with another 1.5Mt to be allocated between 1983 and 1984) Barring natural disasters and crop failures, the withholding of these stocks from the market may help to hold the price above £150/t but will also prevent any breakout above £200/t.

When we calculate method iii) the expenditure are equal to the total does not however mean only in equilibrium when expenditure equals at the latter now

rising ✓

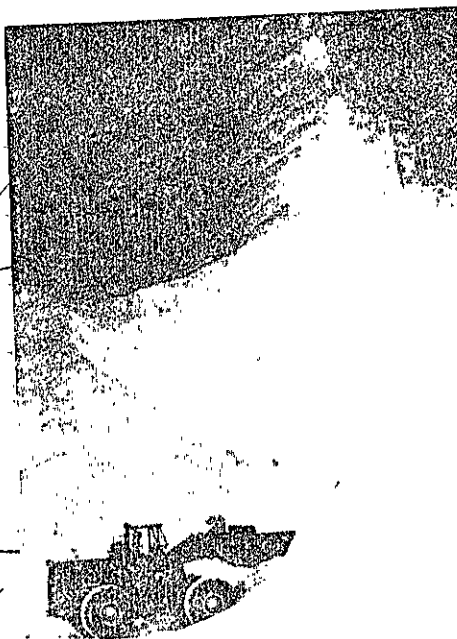
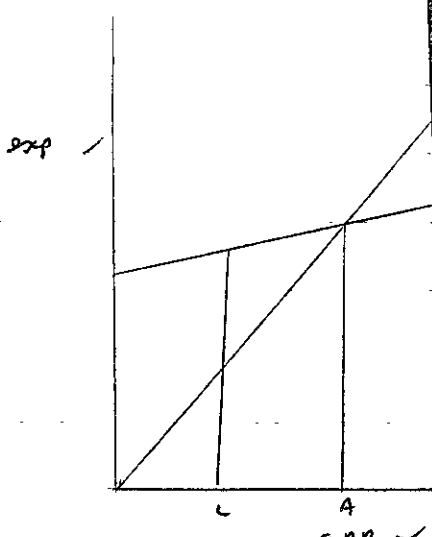

Stockpiled sugar ... hitting the bottom

The above diagram shows is equal to expenditure. At price more is equal to more is not necessarily greater than more this of are needed more than

possibly 2Mt, of its surplus, its 1982 exports could still reach 5Mt (against last year's 4.5Mt).

An ISO spokesman in London told the *FM* that its estimate of a 3.6Mt export surplus (on the basis of 85% quotas) was not "a firm figure." It expects to finalise quotas next month. But whatever the figure, it threatens to leave exporters scrambling for market share to bring them as close as possible to meeting their quotas — unless the "best two of the previous three years" rule is altered.

Latest estimates of the world crop by sugar traders C Czarnikow, are that raw sugar production will be between 95Mt-95.5Mt — after allowing for a 1.5Mt fall in the Soviet union output to 6.25Mt.

greater way of working
normal equals

long this line more
equilibrium because at this
but along the GDP
and C expenditure is
in fact decreasing as they
P is not in equilibrium
some that people are
P, due to Keynes psychology
line at point A the
more is spent

SUGAR (3) Sugar Export scramble
FM 5/3/82

In the face of estimated global sugar surpluses of as much as 4Mt this year, the provisional upward revision of South Africa's basic export tonnage by the International Sugar Organisation (ISO) is largely of

Maize may get R35 m boost through sugar rise

Mercury Reporter

THE increase in the price of sugar could mean a R35 million boost to the maize growing industry as soft drink manufacturers threaten to look to alternative sweeteners.

Mr J H Viljoen, president of the Federation of South African Soft Drink Manufacturers, said while there would be no immediate rise in the price of soft drinks, the 12 percent increase announced by the South African Sugar Association had pushed the price of sugar to the point where it was viable to seek alternative sweeteners.

He said that the soft drink industry was the biggest buyer on the domestic market, using 80 000 tons of sugar a year at a cost of R35 million.

The R50-a-ton increase for sugar meant an extra bill of R4 000 000, but this excluded the rise in transportation costs which added R245 to every truck load needed to transport sugar to the Transvaal, where most manufacturers were situated.

He said the industry was no longer able to absorb these costs, and was considering using high fructose corn sugar, a

sweetener which was synthesised from high starch maize.

Mr Viljoen said the manufacturers were also dissatisfied with the manner in which sugar prices were implemented for the whole of the country from Natal.

Decision

The general manager of the Sugar Association, Mr Peter Sale, said if the soft drink industry stopped buying sugar it would have a great effect on the sugar industry.

'It would have to be their decision. I cannot say it would be likely that we would decrease the price of sugar for the soft drink industry if we find we were going to lose them, without knowing all the facts involved. We would have to consider local consumers and other industries.'

'The soft drink industry does not get an industrial price for sugar as we consider the price to be fair already,' he said.

The chairman of the South African Chocolates and Sweets Manufacturers, Mr Arnold Zulman, said the combination of the sugar increase, rail increases and 10 percent import surcharge would

make the increase of the price of sweets and chocolates inevitable.

As there is no price control in the sweet industry, (as is the case with soft drinks), the increase will depend on individual manufacturers.

Outside of domestic and export consumers who used 71,38 percent of the local market, soft drink manufacturers took 8,64 percent, with sweet makers 5,86 percent, food processors 3,18 percent and sundry users like brewers and liquor makers, the rest.

Most were less quick to react to the sugar increase than the soft drink manufacturers.

A spokesman for the Fruit and Vegetable Canners' Association and the secretary of the Durban and District Master Bakers' Association, Mr C A Z Pierides, said it was too early to comment.

Mercury
6/3/82
Sugar

3 Sugar Harvest 24/3/82 Cane Growers' fund a boon to black farmers

By Deneysel Armour
THE SMALL Cane Growers' Financial Aid Fund was established in 1973 to provide help for farmers who lacked the credit facilities and the capital, equipment, experience and basic essentials to become viable and affluent farmer.

Initiated by the South African Sugar Association, the fund started with R5 million and the full approval of the South African and Kwazulu Governments. Administration costs are paid for by the Sugar Association, so the Fund's entire assets become available for assistance to small growers.

In 1980, the Sugar Association put in an additional R1 million, increasing the Fund's total assets to R6 million. It has now taken to borrowing money on the open market.

haven't experienced very many bad debts. In fact, they are minimal compared to the amount of money lent out. We think this illustrates the large amount of responsibility shown by small farmers.

Mr Bates said that up to end of December 1981 the Fund had granted 8 801 loans to Zulu farmers, 864 to Indian farmers and 50 to coloured farmers. This is out of an estimated 15-16 000 Zulu farms, 1 300 Indian farms and 57 coloured-owned sugar cane farms.

Sugar cane farming has increased most rapidly among black farmers, according to Mr Bates. In 1973 there were only about 4 000, now there are more than 15 000 black cane farmers.

Drought

When the Fund started, 300 000 to 400 000 tons of sugar cane were being produced in Kwazulu. The highest tonnage reached before the 1980 drought was 921 000 tons, more than tripling since the fund started. It would

this time where international quotas can be cut at short notice?

'This is the old question whether there should be expansion or not,' said Mr Bates, drawing attention to the Committee of Inquiry into the Sugar Industry, which is examining this issue at present.

Previously, in times of restriction, no small growers were restricted because cuts applied only to those producing more than 200 tons of sucrose Mr Bates said.

Most problems the Fund encounters are local farmer problems—for example the transport of cane to the mills. But

farmers are advised, and if necessary, aided by the extension services.

'There is an administrative body at each mill where the farmer can see the extension officer or a member of the body. Accessibility of finance is another problem: a trip to Durban is expensive, so we try to keep everything on a local level,' said Mr Bates.

THE FUND will make its 10 000th loan this month and will also hold a ceremony at which an award will be made to the Top Farmer.



Two Kwazulu agricultural officers in a cane-loading zone on the South Coast, established by African growers who have been aided by the Sugar Association's Small Growers' Financial Aid Fund.

Year	1970	1971	1972	1973	1974	1975	1976	1977	1978	1979	1980

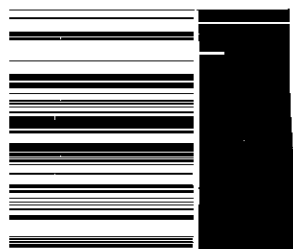

'Challenge to keep farmers on land'

(3) Sugar (1000) Mercury 25/1/88

Financial Editor
THE NATAL and KwaZulu communities face the challenge of keeping farmers on the land and of planting another 40 000 to 50 000 hectares with cane, Mr Dick Ridgway, chairman of the S A Sugar Association, said last night.

He was presenting awards to black farmers who had been helped by the Small Cane Growers' Financial Aid Fund. The function marked the first season in which the small farmers had produced over 1 000 000 tons of cane. Awards were also made by the Natal Agricultural Writers' Association.

Under cane

Mr Ridgway said that since the fund was started in 1973 it had lent over R12,7 million to 10 000 small farmers with Mr

Ndoda Cele from Sezela receiving a plaque last night to mark the 10 000th loan.

Land under cane had grown from 13 000 ha to today's 42 000 ha and the value of the cane farming to KwaZulu had risen from R2,7 million to today's R21 million and was expected to reach R42 million by the 1989/90 season if current progress was maintained.

Mr Ridgway said that the increase in agricultural activity had led to a better system of roads and bridges and the development of prosperous trading centres and other activities in the developing communities.

There was also an increase in employment.

Mr Caleb Mtshali from Entumeni was awarded a Cup as the Natal Zulu Cane Farmer of the year while the runners-up were Mr Simon Zungu from Illovo, Mrs Natalia Nxumalo from Amatikulu and Mr Michael Mahlaba from Tongaat.



MR DICK Ridgway, chairman of the S A Sugar Association (left) congratulates the Natal Zulu Cane Farmer of the Year, Mr Caleb Mtshali from Entumeni. In the picture are runners-up Mr Simon Zungu from Illovo and Mrs Natalia Nxumalo from Amatikulu.

that growers could expect a reasonable crop for the 1982/83 season. Says Peter Sale, general manager of the South African Sugar Association: "At the moment people are talking of a crop in the region of 2-2,1 Mt. Working on average weather conditions, I don't think the final crop figure will be much below that."

According to Sale, the final crop figure for the current season would have been closer to the normal season output of 2,2 Mt but for the lingering effects of the 1980/81 drought. "The quality of cane sent to the mills was not good. The average cane/sugar ratio of 9,5:1 was one of the worst for 40 years."

At the start of the season the crop estimate stood at 1,75 Mt but it was frequently revised upward as the cane in the field benefited from the widespread rain late in the growing period. By the close of the season sugar men were confidently talking of a crop in excess of 2 Mt. Mills started crushing cane fairly late in the season to give the recovering cane additional growth. Consequently, they were late in closing. The last mill to close, Darnall, shut down this week.

The industry's surplus for the current season is likely to be in the region of R40m. Sale says it will be carried over to buffer any deficit next year caused by depressed world prices.

If there is a surplus next year, the cash

will go towards repaying a portion of the industry's R130m loan commitment.

Depressed world sugar prices continue to have a negative effect on the SA sugar industry. The main reasons for the low price is the 4Mt international sugar surplus created by favourable growing conditions in most of the producer countries and the swing among some major sugar consumers to alternative sweeteners such as high fructose corn syrup. At the current low prices the industry has not been able to embark on any profitable forward selling and prospects for an immediate price rise are not good.

But there could be good news for local planters: EEC producer countries may cut back on land planted to beet, and in time this could cause prices to firm.

SUGAR (3) SUGG
Happier outlook

FM 26/3/82

The sugar industry has turned the corner. Final crop figure for the current season was a better-than-expected 2,05Mt and prospects for the forthcoming season, which starts in April, are as good if not better.

Last weekend's soaking rains confirmed



R40m surplus for sugar industry

3 Sugar
27/3/82



Financial Editor
THE SUGAR industry will end the current season with a surplus of R40 000 000 after meeting the costs of millers and growers in full, Mr Frank Jones, chairman of C G Smith Sugar, said at Pongola last night.

ing added (about 290 000 tons) in Durban to gain more flexibility in the export market.

S
F,
s
y
O.
s
n
S
r
s
e
s
r
l-
ly
y
r
e
r
n
d
e
o
i
l

He was speaking at a function to mark milling of 1 000 000 tons of cane in a season at the mill which is on the Natal-Transvaal border.

Mr Jones said the current season would see production in South Africa of 2 050 000 tons of sugar up from the ten-year low of 1,6 million tons last year.

He expects that the new season, after reasonable weather, to produce 2 100 000 tons of sugar, of which about 1,2 million tons would be used in the domestic market.

World price

The world price was notoriously volatile and below the cost of production in South Africa and 'of all cane producers' at present.

The R40-million surplus would be a buffer against continued low world prices which could be expected as the surplus stocks had not been absorbed.

Mr Jones said South Africa had become more competitive on world markets by offering discounts and had looked for new markets — substantial tonnages were going to the United States and Korea.

The quality of sugar remained high and provided price was competitive, Mr Jones foresaw no difficulty in disposing of all the export sugar.

Further storage was be-

P
h
i
t
c
t
R
R
t
p
F
a
a
C
u
p
R
s
t
e
(R

Trade deficit

R40m ^{(3) Sugar} surplus ^{RWH} for SA ^{27/3/82} sugar

a
r-
il-
of
he
ly
n-
ily-
es
m
g
it
ic
r-
to
il-
ut
on
ts
il-
nd
y-
on
ys
g
al
r-
ut
e-
t-
r-
of
id
je
n-
d-
er
of

THE sugar industry would end the current season with a surplus of R40-million after meeting the costs of millers and growers in full, said Mr Frank Jones, chairman of C G Smith Sugar, at Pongola last night.

He was speaking at a function to mark milling of a million tons of cane in a season at the mill on the Natal-Transvaal border.

Mr Jones said the current season's production in South Africa of 2 050 000 tons of sugar would be up from the 10-year low of 1 600 000 tons last year.

He expects the new season, after reasonable weather conditions, will produce 2 100 000 tons of sugar of which about 1 200 000 tons will go to the domestic market.

He said the world price was volatile and was below the cost of production of all cane producers.

The R40-million surplus would be a buffer against continued low world prices which could be expected as the surplus stocks had not been absorbed.

South Africa had become more competitive on world markets by offering discounts and had looked for new markets. Substantial tonnages were going to the United States and Korea.

The quality of sugar remained high and provided price was competitive. Mr Jones saw no difficulty in disposing all the export sugar.

Panafic

US quota move puts sugar exports in jeopardy

NM *Mercury* 6/5/82

(3) *Sugar*

Financial Editor

SOUTH AFRICA's exports of sugar to the United States, which were to be boosted by a R30 million - 100 000 tons a year - contract this year, are at stake as President Reagan slaps on sugar import quotas.

Yesterday Mr David Hardie, export manager of the S A Sugar Association, said that details of the quotas and their effect on local exports were not yet known.

He thought they might be imposed country-by-country and the basis could vary from Customs statistics of U S sugar imports to data from the International Sugar Organisation.

The quota move was 'rather unfortunate' in the light of the recently sealed deal to export 300 000 tons in the next three years. That contract would be worth about R100 million.

Details of the quotas are expected to be known early this morning and are to be adjusted quarterly.

and will be the same for each country.

U S Agriculture Department spokesman Mr Gene Hemphill said the quota for each country shipping sugar to the United States would be a percentage of the average of its shipments for the years 1975 until 1981, excluding the highest and lowest years.

From Washington, Sapa-Associated Press reported that President Reagan, faced with huge U S Government purchases of domestic sugar, has imposed the quota to bolster market prices, and to protect

jeopardy

the new United States Government price support programme for sugar.

Imposition of the quota, abolished in the early 1970s, is an admission that duties and import fees on sugar have failed to protect domestic producers.

The quota will take effect on signing of the presidential proclamation

that imposes it. Mr Hemphill said it would affect imports from the Caribbean Basin, whose sugar producers were to receive special treatment under Mr Reagan's Caribbean Basin initiative.

Import quotas would be certain to affect Australia, the Dominican Republic, Brazil, the Philippines

and other countries. Administration budget experts have estimated that unless quotas are imposed, a glut of supplies in the U S could cost the government one billion dollars to keep prices at an artificial level.

Imports of 4.5 m tons last year amounted to about half the United States sugar consumption.

World sugar prices have plunged 30 percent in the past four months amid the prospect of a large world sugar crop. The problem has been worsened by European government subsidies that assure export of their sugar no matter what the world price, which is now about 9 cents a pound.

Because of the potential cost to the government, Mr Reagan had initially opposed sugar price supports, which were included in the new four-year farm commodity package Congress approved last year.

But he dropped his opposition last summer in return for the votes of sugar-state Southern Democrats on his controversial budget proposals.

Initially, a spokesman said, the government would be able to avoid domestic sugar takeovers through a complex system of import fees and duties that would keep the price of imported sugar above the domestic price.

But he said the continually falling world price had eroded the ability to use fees and duties to maintain market prices, leaving no other choice

but to limit supplies. The duty on sugar is 2.8 cents a pound. Import fees on top of that are half the world price, or a little less than 4.5 cents a pound. An importer thus must mark up his sugar by the sum of those two charges, 8.3 cents, to 17.3 cents a pound before accounting for any other costs.

The department said the 2.8-cent duty would remain, and the import fee would be continued with certain adjustments necessary to reflect changed conditions. It did not spell out those adjustments.

Under the price support programme, the government will buy sugar from eligible processors at 16.75 cents a pound until October.

After that, it will provide loans at 17 cents a pound on the 1982 sugar crop. If those loans are not repaid with interest before October 1983, the government takes ownership of the sugar and the processor keeps the money.

The quota is intended to keep market prices above the support level so processors get more from selling sugar commercially than to the government.

WARNING

1. No books, notes, pieces of paper or other material may be brought into the examination room unless candidates are so instructed.
2. Candidates are not to communicate with other candidates or with any person except the invigilator.
3. No part of an answer book is to be torn out.
4. All answer books must be handed to the commissioner or to an invigilator before leaving the examination.

to disqualification and to possible exclusion from the University

UNIVERSITY OF CAPE TOWN EXAMINATION ANSWER BOOKS

exports in

books must be numbered

YS

continued to high level of de- by the contribution this division of its material- than those he same period

more difficult ons during the the year to but (we) be- income before ems for the full exceed that previous 15- period to Sep- (R13-million)



Mr P R du Toit has been appointed a general manager of Senbank.

BOOK 7/5/82

By PENNY CUMMINS

SOUTH African sugar exports to the US this year will be slashed.

The US has imposed quotas on imports for six weeks from May 11. South African will get 2.3% of the total of 220 000 tons

The size of the cut facing SA sugar can be gauged from its 4 350 metric ton quota against a contract to supply 100 000 tons of sugar annually to one client in the US.

South Africa exports up to a million tons of sugar a year

The miniscule quota for the US will cause a shipping problem as sugar is usually shipped in bulk. It is believed that the consignment for the

~~33774~~ (3) Sugar
**Blow to SA
sugar exports**

US will be parcelled into a Canadian order.

The next US quota will be announced on June 15.

Mr Peter Sale, chairman of the Sugar Association, expects South Africa's allocation for the year will not exceed 56 000 tons.

US sugar refiners have been taking advantage of the low world sugar price, which has undercut the domestic suppliers. But the producers have a long-standing Govern-

ment undertaking to buy in their surplus.

President Reagan says the quota allocation will be applied without discrimination on the basis of the historical share of imports from each country over the past five years

Mr Sale says this might exclude the highest and lowest figure over the period. South Africa has only recently established a regular contract in the US, and previous shipments have been sporadic.

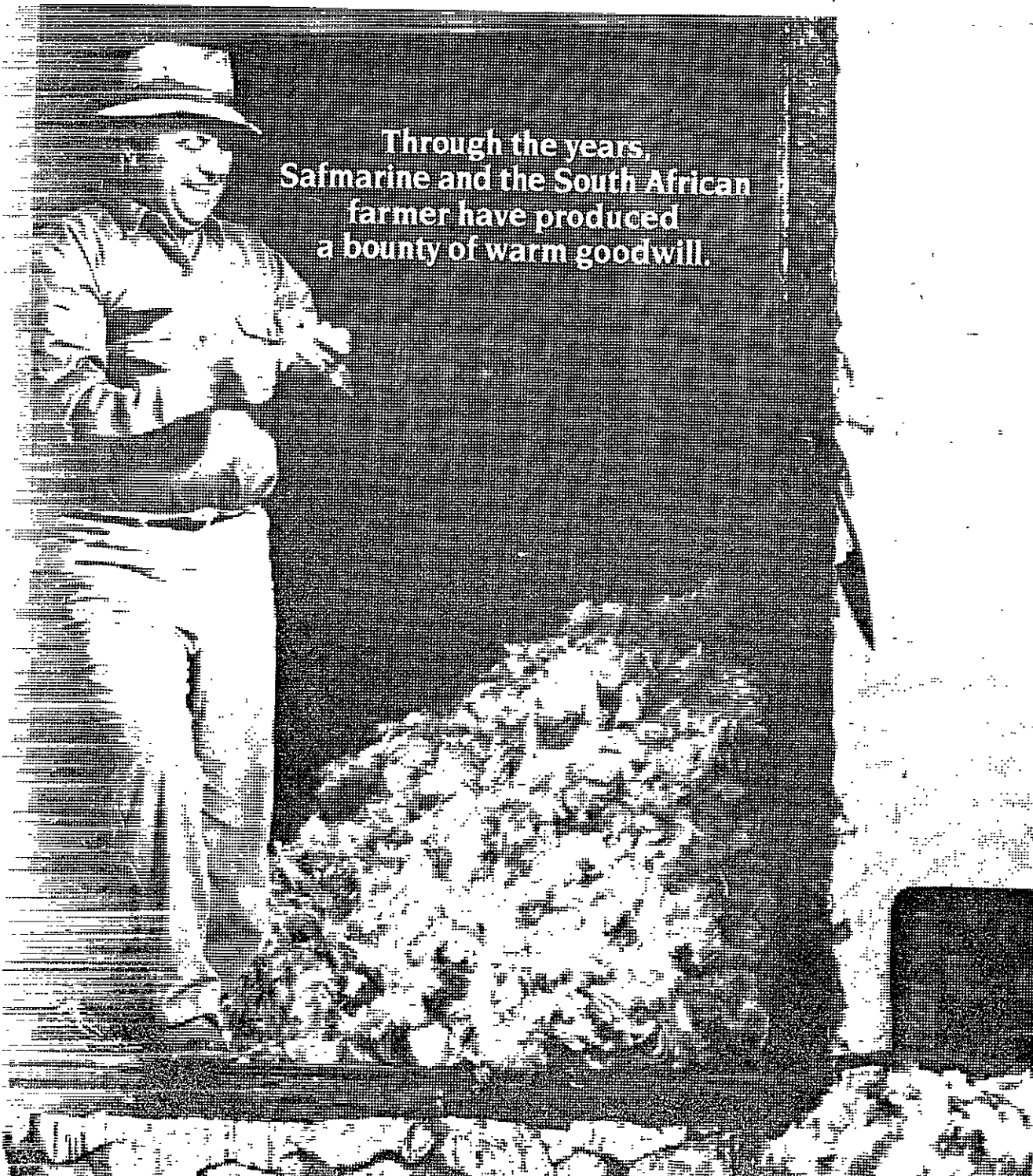

Through the years,
Safmarine and the South African
farmer have produced
a bounty of warm goodwill.

SA⁽³⁾ Sugar

cash

for

30/6/82

DSMITHS UNION

Swazi 5- Times sugar 9/5/82 estate

Year	A
1970	
1971	
1972	
1973	
1974	
1975	
1976	
1977	
1978	
1979	
1980	

By Elizabeth Rouse

CREDIT Guarantee Insurance Corporation is underwriting an export credit for major extensions to the Ubombo Ranches sugar estate at Big Bend in Swaziland.

Contract value of the expansion project is R7,442-million, of which Credit Guarantee will be underwriting 80%.

Ubombo Ranches is part of the London-based Lonrho group headed by British magnate Tiny Rowland.

Mr J J Bouwer, executive director of Credit Guarantee, says that the export credit for the scheme will be used for the expansion of the sugar mill, the development of additional sugar plantations and the expansion of the irrigation scheme.

Address: 201
Cor
Cag
800

Officials: \$

Area of Oper:

Founded: 1

Registration

1974 affiliate
other unions

The project co-ordinator is Barclays National Merchant Bank of Johannesburg, and several South African contractors such as Techserve, Roberts Construction, Winfit Industries and Cosine Engineering will be involved in the expansion programme.

The finance granted will also be used to buy new agricultural machinery.

This is the second time in less than a year that Credit Guarantee has agreed to underwrite an export credit to be used to expand Swaziland's sugar industry.

Towards the end of last year credit insurance totalling about R7,8-million was used for two projects.

Of this amount R4,8-million was used to construct two sugar warehouses at Mlaula and Ubombo. The rest was used to install a boiler for Ubombo Ranches.

As in the case of the latest contract, the project co-ordinator was Barclays National Merchant Bank, which acted as exporter.

membership		
nd	White	Total
	320	418
	294	322
	305	331
	201	222
	347	377
		..
		445
		460

*
*
*
*
*
\$

Fosatu Annual Report 1980/81

Telephone: (021) 433658

disaffiliated by 1977/78 and with
79

es at Sun n cash

SPOTLIGHT

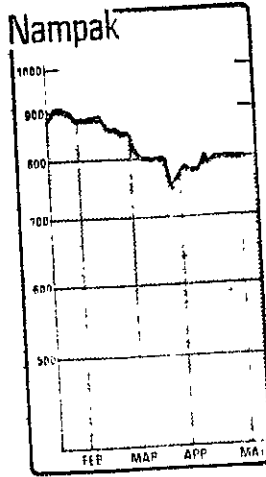

SA to supply 2.3% of US sugar imports

3 Sugar Star
12/5/82

The final dividend has been raised from 20c to 25c a share, lifting the total for the year to 30c to 39c, an increase of 30 percent.

Turnover of the group rose 33 percent to R140.7 million to R88 million out of which operating profit climbed 27 percent to R45.8 million to R32 million.

Interest paid was a 67 percent higher R6.3 million (R3.8 million), leaving profit before tax 23 percent at R45.8 million (R38 million).

Profit after tax was 3 percent up at R37.3 million against R29 million previously.

Earnings attributable to outside shareholders of the Bophuthatswana government has a half share in Sun City — rose 26 percent from 4.9 million to R6.2 million.

Earnings a share were up from 43.5c to 56c.

Having absorbed the start-up costs of the extended facilities at Sun City, the pleasure resort attracted more than 1.5 million visitors and enabled the hotel and cabanas to operate

at 90 percent occupancy rate.

This was higher than the occupancy rate at all the group's hotels which rose to a record 80 percent in spite of the slowdown in the economy.

Mr R J Gose, chairman and Mr Sol Kerzner, managing director, expect the rate of economic growth to decline further during the current financial year and say it is unlikely that the 80 percent occupancy will again be achieved.

CURRENT

They say it is difficult to predict how severely the economic downturn will affect the leisure-and-gaming industry but nevertheless expect the group to at least maintain earnings at last year's levels and perhaps achieve modest growth.

Southern Sun shares have drifted lower in line with the downturn in share prices and at 385c is near its 12-month low of 355c. The prospective dividend yield at the current share price is 10.1 percent.

Nampak's directors, who have just announced a 24 percent increase in attributable income for the six months to March 31 — from R19.5 million in the previous corresponding period to R24 million — say the group is well placed to meet "the challenging times ahead."

On prospects, the directors say that while it is not expected the group will maintain the level of increased earnings for the remainder of the year the group, as restructured, is in a good position to resist the negative forces of the economic downturn.

Nampak's interim dividend was declared at 28c a share compared with 25c and the dividend cover remains unchanged at 2.4.

By John D'Oliveira
The Star Bureau
WASHINGTON — South Africa has been awarded a 2.3 percent share of United States sugar imports.

Following the contentious White House decision to impose sugar quotas in an effort to protect United States sugar growers, the United States Department of Commerce calculated what percentage of the import market should go to each exporting country.

The calculation was based on the imports from each country over the last seven years. After deleting the highest and the lowest quantities, the remaining five years were averaged and the market percentage calculated.

South Africa's share was assessed at 2.3 percent Swaziland's at 1.6 percent and Malawi's at 1.3 percent.

Each quarter the Secretary of Agriculture will determine how much sugar can be im-

ported into the United States — and each country will then be able to export to the United States its allotted portion of that quantity.

Meanwhile, America's independent cane sugar refiners have asked the US Court of International Trade to declare the Reagan sugar quotas illegal.

While the imposition of the quotas will significantly affect the sugar industries in countries like South Africa, Zimbabwe, Swaziland, Mozambique and Malawi, it could hit hard major suppliers like Australia, Brazil and the Dominican Republic.

The United States Cane Sugar Refiners Association refine sugar from both domestic and foreign sources.

They claim the imposition of quotas will greatly increase the cost of the raw sugar they purchase and the refined sugar they sell thereby reducing their share of the domestic sweetener market.

Indicated across: Ruling price, total earnings yield, 12-month high.
Queries on the accuracy of information

Symbol	Price	Yield	High	Symbol	Price	Yield	High										
5950	8.4	13.3	11000	5500	CGSMITH	1550	7.4	16.2	1900	1550	100	SEARDEL CP	650	12.9	710	625	
6180	9.7	20.9	9400	6000	CURFIN	225	14.2	26.8	305	210	SILV TAN	725	5.5	17.1	750	700	
4800	5.4	13.3	6550	4350	D M	445	6.8	18.0	870	575	S A-BIAS	440	6.3	19.3	480	225	
7550	13.2	14.9	12300	7100	DE BOND	102	2	8.9	26.5	135	87	S A WOOL	500	2.0	24.9	550	300
3250	3.7	9.5	3350	2500	DE BOND NPL	18					100	49	13.3	41.2	75	45	
90	10.9	25.1	630	310	DIROYAL	76	10.5	24.5	92	65	1150	50	12.4	75.4	60	50	
350	4.9	9.7	66	38	ENYATI	91					1500	82		14.6	115	45	
38	11.0	23.2	750	385	FED VOLK	390	5	9.0	33.3	605	375	TE J	48	10.0	28.5	56	40
430	5.8	8.6	540	400	FED VOLK CP	420					400	40	11.7		52	40	
400	7.7	17.1	1975	1045	FRENCOR	225					1500	40					
1045	2.8	11.6	1540	750	FRENCORLINKED	280					1500	40					
7800	12.2	12.9	910	760	HLH	545					1500	40					
780	12.2	12.9	910	760	HLH -A-	1300	6.1	20.1	2100	1300	1500	40					
375	12.3	20.4	620	350	1000 ICH	3000	5.2	29.2	3700	2750	1500	40					
195	10.7	15.5	635	420	800 IND INV	160	11.1	15.2	225	150	1500	40					
430	12.7	16.8	1100	725	2700 LONRHO	155	11.3	28.6	220	150	900	78					
820	19.3	44.9	1350	700	LUCEM	20					1500	100					
710	16.8	19.5	1650	910	LUCORP	63					1500	100					
450	6.2	8.7	375	205	3400 MALBAK	410					1500	180					
260	10.9	10.4	1300	600	MALBAK 15%CD	107.0%					1500	50					
685	5.7	6.8	1675	1150	MALBK12 25CD	107.0%					1500	47					
1200					MERTRU	63	5	7.9	32.1	70	465	2150	310	9.0	13.3	400	310
DIAB RAND KRUGER			90.0	75.0	MESSINA	560					1500	310					
87.0%			51000		METJE Z	105					1500	310					
398			25700	230	MICOR	172					1500	310					
215			13200	10500	M R	600					1500	310					
11000			5400	4300	NICTUS	24					1500	310					
4600					PICBEL	400					1500	310					
BANKS					PICBEL	570					1500	310					
FIN SERV					PICFIN	320					1500	310					
24	8.2	43.5	275	205	PLACOP	750					1500	310					
7.9			175	120	PLATE GI	250					1500	310					

3 Sugar
DOM 18/7/82

NE
spe
the
Un
the
pla
du
an
th
pr

co
wa
an
fin
Ch
Lc

'Sugar producers now operate at a loss

By NEIL BEHRMANN on the commodity markets

LONDON. — At current international sugar prices, all producing nations, including South Africa are operating at a loss.

Some nations are locked into contracts while higher local prices subsidise production, but if sugar is sold at today's price of £109 a ton or at 8c to 9c a pound, the exports incur a loss.

A 700-page report by Landell Mills Commodities studies, an independent consultancy firm, concludes, however that South Africa and other Southern and Central African producers are better off than the majority of sugar producing nations

Southern African nations are the lowest cost producers. But, the report's author, Dr James Fry, contends that these nations cannot cover their costs at prices of under 10c a pound.

Many sugar cane and beet producers ranging from Central America to Japan produce their sugar at costs which are some 60% higher than South

Africa. The production costs of these nations range from 11c a pound to 18c a pound — about twice the levels of free market prices.

"South Africa is a very competitive producer because it has good yields, lower irrigation and labour costs," says Dr Fry. "But it is also suffering."

Dr Fry says that sugar moves in long term cycles. In real terms prices are the lowest in the past decade, so several producers will cut production. The market will shift into balance and prices will rise again.

Sugar dealers and analysts however are unconvinced. They maintain that it will take a long time before the market recovers. With sugar production well in excess of demand, it is possible that prices could fall below £100 and even lower.

In line with other sugar firms, the London sugar brokers, C Czarnikow, forecasts that world sugar production will be 97-million tons or 6-

million tons higher than projected consumption.

World sugar stocks are estimated at 31-million tons by the end of August — about a third of consumption. A reasonable stock consumption ratio is about 20% to 25%, so current sugar inventory levels are well above the norm.

Members of the International Sugar Agreement are meeting in London this week, but sugar analysts believe that their efforts will be counter productive.

Delegates must decide on export quotas for 1983 and 1984. These quotas are calculated on the crop performance of member nations.

Although prices have collapsed to uneconomic levels, producers have little incentive to cut production. They believe that output cuts imply that there will be smaller export quotas in future years so they will continue to flood the market with sugar.

VIRO



The lock that keeps YOU safe

COMMUNICATION IFX Computer Based 'om

COMMUNICATION
IFX
Computer Based
'om

SUGAR

Profits cared

3 sugar
FM 28/5/82

Cane growers expect a record 2,1 Mt of sugar for the 1982-83 season. Yet the industry will probably end the year with a huge deficit — mainly due to the deflated world price.

SA Sugar Association (Sasa) GM Peter Sale says although world sugar prices have plummeted over the past few months, there are signs that the market has bottomed out.

"Prices could sag a bit more," he says. "But I don't see them going below \$90/t. In the long term, there is more upward potential than downward potential in the market."

Sugar producers ended last season with a modest surplus of R45m on a smaller crop of 2,05 Mt. But this year could bring a substantial deficit, says Sale. Total cane available for crushing this year is estimated at 20,2 Mt compared with 19,5 Mt last year.

The industry experienced its biggest loss to date during the drought of 1980-81 when it turned in a deficit of R90m. According to Sale, average world prices last season were higher than the prevailing figure. This enabled the industry to make on its exports. "It is highly unlikely," he adds, "that this situation will pertain during the forthcoming season."

Sasa is looking at ways of dealing with the impending deficit. One possible measure is to increase its commercial borrowings. But the industry already has a R130m outstanding loan commitment which it is

reluctant to increase. Other options include government loans or subsidies.

"We are examining all possibilities," says Sale. "It is ironic that the industry is budgeting for a deficit when it is expecting its biggest ever crop."

The exceptional crop is itself part of the problem. World prices are depressed because favourable weather conditions in most of the producer countries have led to bumper crops, swelling the world's sugar surplus to around 6 Mt.

In addition, there has been a worldwide drop in consumption as a result of the competition from alternative sweeteners. Sale says SA's favourable crop expectations for the current season are the result of better-than-average rainfall over most of the growing period. This should also yield a better cane/sugar ratio than the previous season.

At a recent meeting of the International Sugar Organisation (ISO) in London, SA had its quota fixed at 988 000 t until the end of the 1984. However, the quota was cut by 15% this year to 840 000 t. In addition, SA has been instructed by the ISO to increase its stockpile from 52 700 t to 132 000 t to withhold more sugar from world markets.

The ISO has also reduced its subsidy to producers holding stocks from \$33/t to \$15/t.

According to Sale, the extra stockpile requirements will not place the industry under any strain. The industry, he says, was already planning to bring its stockpile to this level by June 1984. There is ample capacity in SA's existing sugar terminals and work on the proposed new R25m terminal at Durban's Maydon Wharf starts next year.

Sugar mill workers on strike

9/6/82
Mercury Reporter

THE entire black work force at the Umfolozi sugar mill has stopped work over the dismissal of two colleagues, the mill's general manager, Mr I Bales-Smith, said yesterday.

The work stoppage, which involves nearly 1 000 mill workers, relates to the dismissal of a worker last month and a dismissal last year.

Mr Bales-Smith said the men had been dismissed for 'contravening the mill's disciplinary procedure'.

He added that only 14 hours' production time had been lost since the beginning of the stoppage, and that the mill was now being run by the white staff.

According to Mr Bales-Smith the men on Monday's 10 p m shift would not start work, and subsequent shifts joined the stoppage. He said he believed a certain amount of intimidation was taking place.

Regarding the dismissal of the two workers, Mr Bales-Smith said he had met the secretary of the National Union of Sugar Manufacturers' and Refining Employees, Mr Selby Nsibande, on Monday afternoon about the dismissals.

'I have since held meetings with union officials and believe that the workers will be going back to their shifts soon,' he said.

Mercury 10/6/82
Umfolozi sugar mill
workers return to work

Mercury Reporter

STRIKING workers from the Umfolozi sugar mill had returned to work by yesterday, according to the mill's general manager, Mr I Bales-Smith.

The entire black workforce of about 1 000 had downed tools on Monday night but, Mr Bales-Smith said, they started to return to work on Tuesday night.

Mr Bales-Smith said the stoppage related to the dismissal of two workers, — one was dismissed last month and the other last year — for 'contravening the mill's disciplinary code'.

He said the workers had returned to work 'because they now understood the

company's grievance code'.

The general secretary of the National Union of Sugar Manufacturers and Refining Employees, Mr Selby Nsibande, said the two men's dismissal had been irrelevant to the stoppage but warned that if any more men were dismissed there would be stoppages again.

Mr Nsibande said a white employee had been dismissed on Tuesday for 'assaulting' a black worker but Mr Bales-Smith denied he had been dismissed.

'The employee was suspended for certain actions which were distasteful to the black members of staff. He later resigned,' Mr Bales-Smith said.

SA sugar ^{(3) Sugar} sold at discount

10/6/82

— US claim

SOUTH Africa has sold 75 000 tons of raw sugar to Japan in the past week, says the general manager of the Sugar Association, Mr Peter Sale.

He was commenting in Durban on a New York report that South Africa sold about 100 000 tons of raw sugar to four Japanese trade houses on Monday.

Japanese traders were unable to confirm the report and put recent purchases from South Africa at between 30 000 and 90 000 tons.

The 75 000 tons of sugar is for July-September delivery

and is part of a long-term agreement whereby Japan buys a minimum 350 000 tons of South African sugar a year.

The Sugar Association does not release prices.

Mr Sale confirms that a South African sugar team is in the Far East on a routine visit to established export markets in South Korea and Japan.

The New York report says South Africa sold about 100 000 tons of raw sugar to four Japanese trade houses at a discount of up to £4 a ton to the London daily sugar price.

The discount is in line with the recent sale by Australia of several cargoes to Japanese houses, say New York sources.

Last week, Tokyo trade sources said Japanese refiners were unwilling to buy South African sugar because offers did not compare favourably with the Australian deal.

Japanese sources expressed doubt over the discount, saying it was more likely that recent sales were done on the basis of executable order. — Reuter.

SUGAR ③ Sugar

Asking for more

Fm 23/6/82

The SA sugar industry is in trouble. With world prices exceptionally low and no recovery in sight, it is facing a deficit of R168m on the current crop.

This week, industry representatives asked Commerce and Industries Minister Dawie de Villiers to bail them out. They were looking for an immediate 10% increase in the domestic price of sugar — only two months after the last price hike in March. De Villiers' initial reaction to the request was said to be far from favourable. But the industry has not given up hope of obtaining some relief through an increased local price. It intends to re-open negotiations with government, possibly in August.

Says Sugar Association GM Peter Sale: "We are not looking for the entire deficit to be covered by the local consumer. We would be happy if we could get back a third. Then we could look at other means of covering the balance." The sugar industry, Sale contends, has a valid case. He points out that in the mid-Seventies the controlled domestic price of sugar was half the cost of production. He estimates that in the past 10 years local consumers have been subsidised to the tune of R195m from the industry's

export earnings. "It's only fair that we should be able to recoup some of that subsidy."

Sale holds that an increase in the domestic sugar price is one sure way of getting the industry back on its feet. He estimates that a 10% price increase could bring the industry R40m in 12 months. But additional direct loans — an option which De Villiers is said to favour — is not the answer.

The industry already has R130m outstanding in the form of medium-term loans as a result of the recent drought. With the anticipated net deficit of R123m — R168m less the R45m surplus on last season's crop — the industry would be facing a loan commitment of some R250m. "To service loans of this order at the current rates of interest, is just not practicable," he says.

What is more likely to emerge as the ultimate solution to the sugar industry's predicament is a combination of measures. A hike in the domestic sugar price; some form of government subsidy or direct government loans at a soft rate of interest; and a reduction in return on capital for both growers and millers.

Says Sale: "The industry must accept that in these depressed conditions it will have to absorb some of the deficit itself." It is clear that the sugar industry is in need of some form of assistance. With a world surplus on the London market standing at around £95/l, there seems little prospect of a price recovery in the 1983-84 season.

Sales says he is surprised at government reluctance to grant a further price increase. After all, he notes, there are two government bodies, the Competition Board and a commission of inquiry into the sugar industry, currently examining the question of de-controlling sugar prices.

"What we would like to see," he says, "is a freer market. It is in our own self-interest to keep prices as low as possible. We don't want artificial sweeteners to make inroads into our market and we don't want to lose consumers. Once the industry has recovered, it can start slowing down the rate of price increases."

Talks start on sugar price hike

③ Sugar Mercury
23/6/82

Financial Editor

THE sugar industry is heading for trouble because of the unexpected low world price, which could mean a loss of R168 million this season.

Talks have started with the Government to raise the local price of sugar.

The industry wants an 8 percent increase at retail level — equal to 5 c for a 1 kg pack now costing 54 c — or a 10 percent rise in the industrial price.

The industry already owes R130 million used to tide it over the recent drought and individual millers and growers have absorbed losses which mean that by next April the industry could have lost more than R300 million.

Not forseen

Mr Ian Smeaton, vice-chairman of the South African Sugar Association, confirmed yesterday that discussions had been held with the Minister of Commerce, Industries and Tourism, Dr Dawie de Villiers, and further talks were planned.

The London sugar price was £170 a ton in late February and, while a dip to £140 or £150 was considered possible by informed sugar brokers, the fall to just below £100 a ton had not been forseen.

The decision to seek a further price increase so soon after the last one in March indicates that the industry does not think

export prices will recover soon, and the world surplus will persist into next year.

Mr Smeaton said: 'South Africa is regarded as one of the lowest cost producers in the world, but it is expected to operate at a considerable financial deficit during the current season.'

'After utilising a surplus of R45 million from last season, this would leave a net deficit of R123 million, which would mean that, on average, all members of the industry would operate at a loss.'

He said initial Government reaction to a request for a special price increase had not been favourable, but the industry had pointed out that in the past 10 years the local consumer had been subsidised by R195 million by the industry.

Millers' Association chief says. . .

Sugar

Mercury

24/6/82

Govt favours loans for sugar industry

Financial Editor

THE GOVERNMENT favours more Government-backed loans for the troubled sugar industry, Mr F R Jones, chairman of the S A Sugar Millers' Association, said yesterday.

Talks were held on Monday with Dr Dawie de Villiers, Minister of Industry, Commerce and Tourism and the Director-General of the department, calling for an immediate increase in the local price of sugar.

Mr Jones said loans could be regarded only as a 'short-term palliative and in the absence of any marked improvement in export earnings, ultimately the corrective solution would have to be found in domestic price increases which may have to be supplemented by further borrowings.'

The solution to the problem could well be a mixture of Government subsidies, such as those for maize and wheat, or Government-backed loans; or a 'direct loan from the Government at a soft rate of interest over a long term; or increasing the domestic price.'

The industry would

have to accept absorbing some of its losses as well.

Mr Jones said that the industry was faced with alarming rises in costs and there was a need to increase productivity — some milling companies had started to do this already.

He warned that with the present selling problems in the industry it would be difficult to pay workers increases above the inflation rate as had been done for the past few years.

'I hope that the workers will reduce their demands accordingly,' he said.

Dealing with industrial relations, Mr Jones said that managements must adopt a flexible attitude towards workers and their problems and 'not underestimate just how aggrieved the employees may be over a particular issue.'

Secondly, unions 'must realise there is a proper forum for consultation and negotiations and a philosophy of strike first and talk later has no place in good industrial relations.'

Hardships

'Strikes cause hardships to employees and should be the measure of last resort, rather than the first.'

On sugar exports, Mr Jones said 842,185 tons had been sold to earn a record R300 million last year with a major market opening up in Korea.

But with estimates of world sugar output at 97m tons this season there was likely to be 10m tons more than last season.

Consumption showed no significant increase, going up by only 1,8m tons to reach 91m tons.

There was a need for a new International Sugar Agreement bringing in the European Economic Community which would bring into the provisions of the agreement the producers who were flooding the market with sugar and pushing the price down.

The ISA agreements relating to stockpiles was helpful but that sugar had to come onto the market sooner or later.

Saunders airs sugar woes

B Sugar
Stan
25/6/82

By David Braun
The sugar industry faced a serious financial situation, Mr Chris Saunders, chairman of the Hulett's Corporation, said yesterday.

He was addressing shareholders at the annual general meeting which overwhelmingly approved the merger of Tongaat and Hulett's into what will become the country's biggest sugar manufacturer.

EXPORT PRICE

"It is difficult to see how the export price of sugar can recover in the near term to a level which equates to the average cost of production in the national industry," said Mr Saunders.

He could not see the export price recovering to the extent of making a contribution to the return on capital allowed by the Government under existing price-control formulas.

SPOT PRICE

"The spot price on the London terminal market has dropped to less than £100 a ton, a level last seen in August 1978. Regrettably, the production of sugar in the world for the current year will exceed consumption by no less than six million tons and the consensus of world opinion is that more than one major disaster in the sugar-producing world is required to restore balance between supply and demand.

"The consequence of this is that the national sugar industry faces a serious financial situation in spite of the R45 million which was contributed to the price stabilisation fund during the last season."

Mr Saunders said the industry had the right to demand some support from national buyers to tide it over the

difficult period ahead.

"It should be recalled that the industry contributed about R195 million towards subsidising the local-market price in previous years."

A LONG AND HAPPY LIFE FORECAST FOR SUGAR MARRIAGE

By MIKE
PEIRSON

THE efficiency with which Tongaat and Hulets have always conducted their affairs was highlighted again at their "wedding" this week.

"Best man" Chris Saunders speaking at the merger reception at the Tongaat HQ confidently predicted a long and prosperous life for the "happy couple" despite extra-marital difficulties caused by the drop in the world sugar price.

In this regard the honeymoon is probably over before it begins, but said Saunders: "These matters are of considerable short-term concern, but we should retain our perspective and realise that sugar has always been, and will continue to be, a cyclical crop."

He added that it was difficult to see how the export price of sugar could recover in the near term to a level which equated with the average cost of production in the SA industry.

The consensus of opinion among world sugar brokers (with the spot price below £100), was that more than one major disaster in the sugar producing world was required to restore the balance between supply and demand.

The local industry faced a serious financial situation despite the R45-million which had been contributed to the price stabilisation fund during the last season.

This would have to be drawn out again in the current season to supplement proceeds.

"It should be recalled," he said, "that the industry contributed approximately R195-million towards subsidising the local market price in prior years and, unpalatable as it may be, the industry has the right to demand some support from the South African consumer to tide it over the difficult period which lies ahead.

"I believe that as long as the industry remains a controlled industry, it should receive its full costs and returns, and it is incumbent upon the authorities to find ways and means of correcting the present situation."

He added that the new group could not escape the effects of the current adverse economic climate, high rate of inflation and the high cost of money. The combination of these influences would undoubtedly result in the current financial year being difficult.

Thursday's meetings were the last individual annual meetings of the groups and the merger sessions went off without a hitch.

Assuming the Supreme Court sanctions the "marriage" the new R1200-million group to be known as the Tongaat-Hulett Group will come into being during the coming week.

The best wedding present it could have would be for the Government to agree to an increase in the local price of sugar.

See Also Page 5

3 Sugar

SUGAR SPOILERS BLAMED FOR LOSS

ONE of the most damaging factors affecting the low price of sugar on the international market has been the increase in exports by non-members of the International Sugar Organisation who are not subject to the discipline of production restrictions.

This is the view of Frank Jones, chairman of the South African Sugar Millers' Association, who said in his annual report presented in Durban this week that non-member exports had risen to 6-million tons this year — one million up on 1981. This is notwithstanding the decision of the EEC to stockpile 2.2-million tons of its production — the major portion of which is understood to be subsidised at £184 per ton.

In deciding to extend the agreement for a further two years, it has been agreed that the basic export tonnages for 1983/4 be maintained at this year's levels.

South Africa's 1982 B.E.T. will be 1 033 035 tons raw value and, applying the maximum restriction of 15 per-

By MIKE PEIRSON
Finance Editor

cent, will result in a quota-in-effect of 878 080 tons.

It has also been decided to stockpile a million tons by the end of this month and a further 1.5-million by December 31, 1983. This together with the present EEC stockpile will bring the total of special stocks to 4.7-million.

"In the short term," said Jones, "this may be a palliative and may prevent an even greater slide in prices but the sugar is still there and, sooner or later, it must find its way on to the market."

"I believe that the solution to this over supply and low price problem is for the ISO to take positive steps towards the negotiation of a new agreement



Frank Jones
options open

which must include the EEC as an exporting member.

"Such a new agreement would have to achieve a better correlation between supply and demand by ensuring that the aggregate of basic export tonnages is more closely related to the free market than at present"

Jones said it was necessary both sides learned from the industrial unrest in the past year. Management should adopt a flexible approach to employees' problems and unions should realise there was a proper forum for consultation and negotiation. A philosophy of strike first and talk later had no place in good industrial relations.

Pensions, which had been the major point of contention, belonged in the collective bargaining process.

Jones said that because of high labour costs there would be an increasing trend towards automation and mechanisation.

Operating budgets

and employee complements are being examined more critically than before," he said

"For the past few years we have granted wage increases to unskilled and semi-skilled employees at a level well above the inflation rate. With the state of the world sugar market, we can no longer afford such generosity. With the national economy moving into recession, I can only hope that the unions will reduce their demands accordingly.

"In the current season, although the cane crop seems set for a record production of more than 2.2-million tons, the world price (at R95) is well below the cost of production of the sugar industry.

"Even after bringing to account the R45.7-million surplus from last season, the total proceeds will fall far short of meeting the requirements of the milling and growing sections of the industry.

The industry's estimated deficit for the 1982/83 season is in the order of R120-million. It is well beyond the capacity of the industry to absorb a deficit of this magnitude because it would not only mean having to forego our total returns on capital, as provided for in the price formula, but would also deny the industry the recovery of a significant sum in respect of production costs.

"What is even more alarming is that there seems little prospect of any material recovery in the price in the 1983/4 season."

Regrettably, there were only few options open but they had to be explored.

They were:

- A form of government subsidy;
 - Further Government-backed loans;
 - The domestic price backed loans;
 - A direct Government loan at a soft rate of interest for a relatively long term; and
- of sugar could be increased.

On the last point a special meeting had been held this week with the Minister of Industry, Dr De Villiers.

"While the minister was more favourably inclined towards further government-backed loans, this can only be regarded as a short-term palliative. And in the absence of any marked improvement in export earnings ultimately the corrective solution would have to be found in domestic price increases which may, depending on the circumstances at the time, have to be supplemented by additional borrowing."

No decision was reached at this week's meeting and further representations are expected to be made.

Sugar crisis 'is a myth' ^{11/7/82} ^{(3) Sugar S. Times}

THERE is no crisis facing the South African sugar industry.

The R800-million industry could overcome its loan commitments of R130-million and the deficit of R100-million it faces on this year's crop by the middle of the decade if prices return to levels around R500 a ton.

This is the opinion of a number of the country's leading sugar barons who spoke to Business Times in Durban this week.

"The mere fact that the London futures market is at a premium (R280 a ton) to the LDP fixing (at the time of going to press R236, but under R200 a week ago) indicates buyers' feelings," says Frank Jones, chairman of the SA Sugar Millers' Association.

At an export price of R360 a ton, the industry would recover costs and achieve its allowed margins.

Although international price rises seem unlikely,

By Colin Bower

with a bumper crop expected in EEC countries this year, the industry is susceptible to erratic fluctuations, and production difficulties in any of the world's other major producers would help to raise the price.

"The industry has an enormous in-built flexibility," says C G Smith managing director Tony Norton.

"Despite the fact that we have not been able to achieve our returns for four of the past five years, we are still making healthy profits.

"Although we may have some short-term problems — and they are problems that must be solved — the long-term outlook for a low-cost producer like South Africa is good."

The problem Mr Norton refers to is the R100-million deficit the industry faces at current domestic and world prices. It will be solved only by applying a combination of measures:

- A domestic price increase, which will be larger the longer it is left.
- Soft loans, either directly funded by the Government or guaranteed by it.
- The acceptance of narrower short-term returns by the industry itself.

More men out ~~at~~ ~~Umfolozi~~ ~~mill~~

Mercury 29/7/82 ~~3~~ 3 Sugar

Mercury Reporter
MORE workers have joined the strike at the Umfolozi sugar mill bringing the number of strikers up to more than 1 000, according to the mill's general manager, Mr I Bales-Smith.

He said yesterday the night shift had not turned up to work on Tuesday. This follows the downing of tools by about 400 workers during the day over

wage and other grievances. He said another meeting had been held yesterday with the local workers' committee, but no move had been made to return to work.

'We told them we would look into the question of transport workers being able to clock on and off and would look at certain job descriptions with a view to possible reclassification.

SUGAR (3) SUGAR
New agreement

FM 30/1/82

Negotiations have begun on a new International Sugar Agreement (ISA) which could mean lower quotas for SA producers. But local sugar men feel this would be preferable to the resulting price war if sugar exporting countries fail to agree on how to dispose of their surpluses.

It is generally held that the current ISA has not been successful in regulating world sugar prices. In the four and a half years of its existence world prices have been within the prescribed range for only six months.

Part of the reason is that EEC countries, which are major producers, are not signatories to the ISA. Last year the EEC placed 5,1 Mt of sugar on world markets currently burdened with a 30 Mt surplus.

Most producers now agree that a new agreement will work only if the EEC can be brought into it. They argue that if the EEC remains outside of the agreement, and hence not subject to quota restrictions and stock holding requirements, it will be impossible to bring equilibrium to the world sugar market.

Says Dave Hardy, export manager of the South African Sugar Association: "It is generally recognised that the EEC has become such a powerful force in the market that having them outside the agreement is not serving the interests of the members. Any new agreement will have to take consideration of the EEC.

As a major sugar producer, the EEC will obviously want to negotiate the biggest possible export quota for itself should it enter the agreement. This could impinge upon the quotas of other exporting countries."

In addition, the EEC is thought to favour holding back stocks as the major market regulating mechanism, while most other exporters tend towards quota restrictions as the most effective means of bringing stability to the market.

There is, of course, the possibility that the differences between the ISA members and the EEC are too wide to be accommodated. If this is the case, sugar men say the current agreement may lapse in 1984 without a new agreement being drawn up.

"We could enter a period like we did in 1969 when for five years there was no sugar agreement and an open market," says one sugar man.

Hardy believes that in spite of the difficulties, a way will be found to bring the EEC into the agreement. And he notes that the Confederation of European Beet Growers has signalled its willingness to take part in discussions on a new agreement — a departure from its previous position.

Talks between the ISA members and the EEC are already in progress and the next major meeting is scheduled for November this year.

(4)



First move today on Tiger-Sugar company

enter in question h it has s (2) and

(3) Sugar (1876) ~~1877~~ ~~1878~~ ~~1879~~ ~~1880~~ ~~1881~~ ~~1882~~ ~~1883~~ ~~1884~~ ~~1885~~ ~~1886~~ ~~1887~~ ~~1888~~ ~~1889~~ ~~1890~~ ~~1891~~ ~~1892~~ ~~1893~~ ~~1894~~ ~~1895~~ ~~1896~~ ~~1897~~ ~~1898~~ ~~1899~~ ~~1900~~ ~~1901~~ ~~1902~~ ~~1903~~ ~~1904~~ ~~1905~~ ~~1906~~ ~~1907~~ ~~1908~~ ~~1909~~ ~~1910~~ ~~1911~~ ~~1912~~ ~~1913~~ ~~1914~~ ~~1915~~ ~~1916~~ ~~1917~~ ~~1918~~ ~~1919~~ ~~1920~~ ~~1921~~ ~~1922~~ ~~1923~~ ~~1924~~ ~~1925~~ ~~1926~~ ~~1927~~ ~~1928~~ ~~1929~~ ~~1930~~ ~~1931~~ ~~1932~~ ~~1933~~ ~~1934~~ ~~1935~~ ~~1936~~ ~~1937~~ ~~1938~~ ~~1939~~ ~~1940~~ ~~1941~~ ~~1942~~ ~~1943~~ ~~1944~~ ~~1945~~ ~~1946~~ ~~1947~~ ~~1948~~ ~~1949~~ ~~1950~~ ~~1951~~ ~~1952~~ ~~1953~~ ~~1954~~ ~~1955~~ ~~1956~~ ~~1957~~ ~~1958~~ ~~1959~~ ~~1960~~ ~~1961~~ ~~1962~~ ~~1963~~ ~~1964~~ ~~1965~~ ~~1966~~ ~~1967~~ ~~1968~~ ~~1969~~ ~~1970~~ ~~1971~~ ~~1972~~ ~~1973~~ ~~1974~~ ~~1975~~ ~~1976~~ ~~1977~~ ~~1978~~ ~~1979~~ ~~1980~~ ~~1981~~ ~~1982~~ ~~1983~~ ~~1984~~ ~~1985~~ ~~1986~~ ~~1987~~ ~~1988~~ ~~1989~~ ~~1990~~ ~~1991~~ ~~1992~~ ~~1993~~ ~~1994~~ ~~1995~~ ~~1996~~ ~~1997~~ ~~1998~~ ~~1999~~ ~~2000~~ ~~2001~~ ~~2002~~ ~~2003~~ ~~2004~~ ~~2005~~ ~~2006~~ ~~2007~~ ~~2008~~ ~~2009~~ ~~2010~~ ~~2011~~ ~~2012~~ ~~2013~~ ~~2014~~ ~~2015~~ ~~2016~~ ~~2017~~ ~~2018~~ ~~2019~~ ~~2020~~ ~~2021~~ ~~2022~~ ~~2023~~ ~~2024~~ ~~2025~~ ~~2026~~ ~~2027~~ ~~2028~~ ~~2029~~ ~~2030~~ ~~2031~~ ~~2032~~ ~~2033~~ ~~2034~~ ~~2035~~ ~~2036~~ ~~2037~~ ~~2038~~ ~~2039~~ ~~2040~~ ~~2041~~ ~~2042~~ ~~2043~~ ~~2044~~ ~~2045~~ ~~2046~~ ~~2047~~ ~~2048~~ ~~2049~~ ~~2050~~ ~~2051~~ ~~2052~~ ~~2053~~ ~~2054~~ ~~2055~~ ~~2056~~ ~~2057~~ ~~2058~~ ~~2059~~ ~~2060~~ ~~2061~~ ~~2062~~ ~~2063~~ ~~2064~~ ~~2065~~ ~~2066~~ ~~2067~~ ~~2068~~ ~~2069~~ ~~2070~~ ~~2071~~ ~~2072~~ ~~2073~~ ~~2074~~ ~~2075~~ ~~2076~~ ~~2077~~ ~~2078~~ ~~2079~~ ~~2080~~ ~~2081~~ ~~2082~~ ~~2083~~ ~~2084~~ ~~2085~~ ~~2086~~ ~~2087~~ ~~2088~~ ~~2089~~ ~~2090~~ ~~2091~~ ~~2092~~ ~~2093~~ ~~2094~~ ~~2095~~ ~~2096~~ ~~2097~~ ~~2098~~ ~~2099~~ ~~2100~~ ~~2101~~ ~~2102~~ ~~2103~~ ~~2104~~ ~~2105~~ ~~2106~~ ~~2107~~ ~~2108~~ ~~2109~~ ~~2110~~ ~~2111~~ ~~2112~~ ~~2113~~ ~~2114~~ ~~2115~~ ~~2116~~ ~~2117~~ ~~2118~~ ~~2119~~ ~~2120~~ ~~2121~~ ~~2122~~ ~~2123~~ ~~2124~~ ~~2125~~ ~~2126~~ ~~2127~~ ~~2128~~ ~~2129~~ ~~2130~~ ~~2131~~ ~~2132~~ ~~2133~~ ~~2134~~ ~~2135~~ ~~2136~~ ~~2137~~ ~~2138~~ ~~2139~~ ~~2140~~ ~~2141~~ ~~2142~~ ~~2143~~ ~~2144~~ ~~2145~~ ~~2146~~ ~~2147~~ ~~2148~~ ~~2149~~ ~~2150~~ ~~2151~~ ~~2152~~ ~~2153~~ ~~2154~~ ~~2155~~ ~~2156~~ ~~2157~~ ~~2158~~ ~~2159~~ ~~2160~~ ~~2161~~ ~~2162~~ ~~2163~~ ~~2164~~ ~~2165~~ ~~2166~~ ~~2167~~ ~~2168~~ ~~2169~~ ~~2170~~ ~~2171~~ ~~2172~~ ~~2173~~ ~~2174~~ ~~2175~~ ~~2176~~ ~~2177~~ ~~2178~~ ~~2179~~ ~~2180~~ ~~2181~~ ~~2182~~ ~~2183~~ ~~2184~~ ~~2185~~ ~~2186~~ ~~2187~~ ~~2188~~ ~~2189~~ ~~2190~~ ~~2191~~ ~~2192~~ ~~2193~~ ~~2194~~ ~~2195~~ ~~2196~~ ~~2197~~ ~~2198~~ ~~2199~~ ~~2200~~ ~~2201~~ ~~2202~~ ~~2203~~ ~~2204~~ ~~2205~~ ~~2206~~ ~~2207~~ ~~2208~~ ~~2209~~ ~~2210~~ ~~2211~~ ~~2212~~ ~~2213~~ ~~2214~~ ~~2215~~ ~~2216~~ ~~2217~~ ~~2218~~ ~~2219~~ ~~2220~~ ~~2221~~ ~~2222~~ ~~2223~~ ~~2224~~ ~~2225~~ ~~2226~~ ~~2227~~ ~~2228~~ ~~2229~~ ~~2230~~ ~~2231~~ ~~2232~~ ~~2233~~ ~~2234~~ ~~2235~~ ~~2236~~ ~~2237~~ ~~2238~~ ~~2239~~ ~~2240~~ ~~2241~~ ~~2242~~ ~~2243~~ ~~2244~~ ~~2245~~ ~~2246~~ ~~2247~~ ~~2248~~ ~~2249~~ ~~2250~~ ~~2251~~ ~~2252~~ ~~2253~~ ~~2254~~ ~~2255~~ ~~2256~~ ~~2257~~ ~~2258~~ ~~2259~~ ~~2260~~ ~~2261~~ ~~2262~~ ~~2263~~ ~~2264~~ ~~2265~~ ~~2266~~ ~~2267~~ ~~2268~~ ~~2269~~ ~~2270~~ ~~2271~~ ~~2272~~ ~~2273~~ ~~2274~~ ~~2275~~ ~~2276~~ ~~2277~~ ~~2278~~ ~~2279~~ ~~2280~~ ~~2281~~ ~~2282~~ ~~2283~~ ~~2284~~ ~~2285~~ ~~2286~~ ~~2287~~ ~~2288~~ ~~2289~~ ~~2290~~ ~~2291~~ ~~2292~~ ~~2293~~ ~~2294~~ ~~2295~~ ~~2296~~ ~~2297~~ ~~2298~~ ~~2299~~ ~~2300~~ ~~2301~~ ~~2302~~ ~~2303~~ ~~2304~~ ~~2305~~ ~~2306~~ ~~2307~~ ~~2308~~ ~~2309~~ ~~2310~~ ~~2311~~ ~~2312~~ ~~2313~~ ~~2314~~ ~~2315~~ ~~2316~~ ~~2317~~ ~~2318~~ ~~2319~~ ~~2320~~ ~~2321~~ ~~2322~~ ~~2323~~ ~~2324~~ ~~2325~~ ~~2326~~ ~~2327~~ ~~2328~~ ~~2329~~ ~~2330~~ ~~2331~~ ~~2332~~ ~~2333~~ ~~2334~~ ~~2335~~ ~~2336~~ ~~2337~~ ~~2338~~ ~~2339~~ ~~2340~~ ~~2341~~ ~~2342~~ ~~2343~~ ~~2344~~ ~~2345~~ ~~2346~~ ~~2347~~ ~~2348~~ ~~2349~~ ~~2350~~ ~~2351~~ ~~2352~~ ~~2353~~ ~~2354~~ ~~2355~~ ~~2356~~ ~~2357~~ ~~2358~~ ~~2359~~ ~~2360~~ ~~2361~~ ~~2362~~ ~~2363~~ ~~2364~~ ~~2365~~ ~~2366~~ ~~2367~~ ~~2368~~ ~~2369~~ ~~2370~~ ~~2371~~ ~~2372~~ ~~2373~~ ~~2374~~ ~~2375~~ ~~2376~~ ~~2377~~ ~~2378~~ ~~2379~~ ~~2380~~ ~~2381~~ ~~2382~~ ~~2383~~ ~~2384~~ ~~2385~~ ~~2386~~ ~~2387~~ ~~2388~~ ~~2389~~ ~~2390~~ ~~2391~~ ~~2392~~ ~~2393~~ ~~2394~~ ~~2395~~ ~~2396~~ ~~2397~~ ~~2398~~ ~~2399~~ ~~2400~~ ~~2401~~ ~~2402~~ ~~2403~~ ~~2404~~ ~~2405~~ ~~2406~~ ~~2407~~ ~~2408~~ ~~2409~~ ~~2410~~ ~~2411~~ ~~2412~~ ~~2413~~ ~~2414~~ ~~2415~~ ~~2416~~ ~~2417~~ ~~2418~~ ~~2419~~ ~~2420~~ ~~2421~~ ~~2422~~ ~~2423~~ ~~2424~~ ~~2425~~ ~~2426~~ ~~2427~~ ~~2428~~ ~~2429~~ ~~2430~~ ~~2431~~ ~~2432~~ ~~2433~~ ~~2434~~ ~~2435~~ ~~2436~~ ~~2437~~ ~~2438~~ ~~2439~~ ~~2440~~ ~~2441~~ ~~2442~~ ~~2443~~ ~~2444~~ ~~2445~~ ~~2446~~ ~~2447~~ ~~2448~~ ~~2449~~ ~~2450~~ ~~2451~~ ~~2452~~ ~~2453~~ ~~2454~~ ~~2455~~ ~~2456~~ ~~2457~~ ~~2458~~ ~~2459~~ ~~2460~~ ~~2461~~ ~~2462~~ ~~2463~~ ~~2464~~ ~~2465~~ ~~2466~~ ~~2467~~ ~~2468~~ ~~2469~~ ~~2470~~ ~~2471~~ ~~2472~~ ~~2473~~ ~~2474~~ ~~2475~~ ~~2476~~ ~~2477~~ ~~2478~~ ~~2479~~ ~~2480~~ ~~2481~~ ~~2482~~ ~~2483~~ ~~2484~~ ~~2485~~ ~~2486~~ ~~2487~~ ~~2488~~ ~~2489~~ ~~2490~~ ~~2491~~ ~~2492~~ ~~2493~~ ~~2494~~ ~~2495~~ ~~2496~~ ~~2497~~ ~~2498~~ ~~2499~~ ~~2500~~ ~~2501~~ ~~2502~~ ~~2503~~ ~~2504~~ ~~2505~~ ~~2506~~ ~~2507~~ ~~2508~~ ~~2509~~ ~~2510~~ ~~2511~~ ~~2512~~ ~~2513~~ ~~2514~~ ~~2515~~ ~~2516~~ ~~2517~~ ~~2518~~ ~~2519~~ ~~2520~~ ~~2521~~ ~~2522~~ ~~2523~~ ~~2524~~ ~~2525~~ ~~2526~~ ~~2527~~ ~~2528~~ ~~2529~~ ~~2530~~ ~~2531~~ ~~2532~~ ~~2533~~ ~~2534~~ ~~2535~~ ~~2536~~ ~~2537~~ ~~2538~~ ~~2539~~ ~~2540~~ ~~2541~~ ~~2542~~ ~~2543~~ ~~2544~~ ~~2545~~ ~~2546~~ ~~2547~~ ~~2548~~ ~~2549~~ ~~2550~~ ~~2551~~ ~~2552~~ ~~2553~~ ~~2554~~ ~~2555~~ ~~2556~~ ~~2557~~ ~~2558~~ ~~2559~~ ~~2560~~ ~~2561~~ ~~2562~~ ~~2563~~ ~~2564~~ ~~2565~~ ~~2566~~ ~~2567~~ ~~2568~~ ~~2569~~ ~~2570~~ ~~2571~~ ~~2572~~ ~~2573~~ ~~2574~~ ~~2575~~ ~~2576~~ ~~2577~~ ~~2578~~ ~~2579~~ ~~2580~~ ~~2581~~ ~~2582~~ ~~2583~~ ~~2584~~ ~~2585~~ ~~2586~~ ~~2587~~ ~~2588~~ ~~2589~~ ~~2590~~ ~~2591~~ ~~2592~~ ~~2593~~ ~~2594~~ ~~2595~~ ~~2596~~ ~~2597~~ ~~2598~~ ~~2599~~ ~~2600~~ ~~2601~~ ~~2602~~ ~~2603~~ ~~2604~~ ~~2605~~ ~~2606~~ ~~2607~~ ~~2608~~ ~~2609~~ ~~2610~~ ~~2611~~ ~~2612~~ ~~2613~~ ~~2614~~ ~~2615~~ ~~2616~~ ~~2617~~ ~~2618~~ ~~2619~~ ~~2620~~ ~~2621~~ ~~2622~~ ~~2623~~ ~~2624~~ ~~2625~~ ~~2626~~ ~~2627~~ ~~2628~~ ~~2629~~ ~~2630~~ ~~2631~~ ~~2632~~ ~~2633~~ ~~2634~~ ~~2635~~ ~~2636~~ ~~2637~~ ~~2638~~ ~~2639~~ ~~2640~~ ~~2641~~ ~~2642~~ ~~2643~~ ~~2644~~ ~~2645~~ ~~2646~~ ~~2647~~ ~~2648~~ ~~2649~~ ~~2650~~ ~~2651~~ ~~2652~~ ~~2653~~ ~~2654~~ ~~2655~~ ~~2656~~ ~~2657~~ ~~2658~~ ~~2659~~ ~~2660~~ ~~2661~~ ~~2662~~ ~~2663~~ ~~2664~~ ~~2665~~ ~~2666~~ ~~2667~~ ~~2668~~ ~~2669~~ ~~2670~~ ~~2671~~ ~~2672~~ ~~2673~~ ~~2674~~ ~~2675~~ ~~2676~~ ~~2677~~ ~~2678~~ ~~2679~~ ~~2680~~ ~~2681~~ ~~2682~~ ~~2683~~ ~~2684~~ ~~2685~~ ~~2686~~ ~~2687~~ ~~2688~~ ~~2689~~ ~~2690~~ ~~2691~~ ~~2692~~ ~~2693~~ ~~2694~~ ~~2695~~ ~~2696~~ ~~2697~~ ~~2698~~ ~~2699~~ ~~2700~~ ~~2701~~ ~~2702~~ ~~2703~~ ~~2704~~ ~~2705~~ ~~2706~~ ~~2707~~ ~~2708~~ ~~2709~~ ~~2710~~ ~~2711~~ ~~2712~~ ~~2713~~ ~~2714~~ ~~2715~~ ~~2716~~ ~~2717~~ ~~2718~~ ~~2719~~ ~~2720~~ ~~2721~~ ~~2722~~ ~~2723~~ ~~2724~~ ~~2725~~ ~~2726~~ ~~2727~~ ~~2728~~ ~~2729~~ ~~2730~~ ~~2731~~ ~~2732~~ ~~2733~~ ~~2734~~ ~~2735~~ ~~2736~~ ~~2737~~ ~~2738~~ ~~2739~~ ~~2740~~ ~~2741~~ ~~2742~~ ~~2743~~ ~~2744~~ ~~2745~~ ~~2746~~ ~~2747~~ ~~2748~~ ~~2749~~ ~~2750~~ ~~2751~~ ~~2752~~ ~~2753~~ ~~2754~~ ~~2755~~ ~~2756~~ ~~2757~~ ~~2758~~ ~~2759~~ ~~2760~~ ~~2761~~ ~~2762~~ ~~2763~~ ~~2764~~ ~~2765~~ ~~2766~~ ~~2767~~ ~~2768~~ ~~2769~~ ~~2770~~ ~~2771~~ ~~2772~~ ~~2773~~ ~~2774~~ ~~2775~~ ~~2776~~ ~~2777~~ ~~2778~~ ~~2779~~ ~~2780~~ ~~2781~~ ~~2782~~ ~~2783~~ ~~2784~~ ~~2785~~ ~~2786~~ ~~2787~~ ~~2788~~ ~~2789~~ ~~2790~~ ~~2791~~ ~~2792~~ ~~2793~~ ~~2794~~ ~~2795~~ ~~2796~~ ~~2797~~ ~~2798~~ ~~2799~~ ~~2800~~ ~~2801~~ ~~2802~~ ~~2803~~ ~~2804~~ ~~2805~~ ~~2806~~ ~~2807~~ ~~2808~~ ~~2809~~ ~~2810~~ ~~2811~~ ~~2812~~ ~~2813~~ ~~2814~~ ~~2815~~ ~~2816~~ ~~2817~~ ~~2818~~ ~~2819~~ ~~2820~~ ~~2821~~ ~~2822~~ ~~2823~~ ~~2824~~ ~~2825~~ ~~2826~~ ~~2827~~ ~~2828~~ ~~2829~~ ~~2830~~ ~~2831~~ ~~2832~~ ~~2833~~ ~~2834~~ ~~2835~~ ~~2836~~ ~~2837~~ ~~2838~~ ~~2839~~ ~~2840~~ ~~2841~~ ~~2842~~ ~~2843~~ ~~2844~~ ~~2845~~ ~~2846~~ ~~2847~~ ~~2848~~ ~~2849~~ ~~2850~~ ~~2851~~ ~~2852~~ ~~2853~~ ~~2854~~ ~~2855~~ ~~2856~~ ~~2857~~ ~~2858~~ ~~2859~~ ~~2860~~ ~~2861~~ ~~2862~~ ~~2863~~ ~~2864~~ ~~2865~~ ~~2866~~ ~~2867~~ ~~2868~~ ~~2869~~ ~~2870~~ ~~2871~~ ~~2872~~ ~~2873~~ ~~2874~~ ~~2875~~ ~~2876~~ ~~2877~~ ~~2878~~ ~~2879~~ ~~2880~~ ~~2881~~ ~~2882~~ ~~2883~~ ~~2884~~ ~~2885~~ ~~2886~~ ~~2887~~ ~~2888~~ ~~2889~~ ~~2890~~ ~~2891~~ ~~2892~~ ~~2893~~ ~~2894~~ ~~2895~~ ~~2896~~ ~~2897~~ ~~2898~~ ~~2899~~ ~~2900~~ ~~2901~~ ~~2902~~ ~~2903~~ ~~2904~~ ~~2905~~ ~~2906~~ ~~2907~~ ~~2908~~ ~~2909~~ ~~2910~~ ~~2911~~ ~~2912~~ ~~2913~~ ~~2914~~ ~~2915~~ ~~2916~~ ~~2917~~ ~~2918~~ ~~2919~~ ~~2920~~ ~~2921~~ ~~2922~~ ~~2923~~ ~~2924~~ ~~2925~~ ~~2926~~ ~~2927~~ ~~2928~~ ~~2929~~ ~~2930~~ ~~2931~~ ~~2932~~ ~~2933~~ ~~2934~~ ~~2935~~ ~~2936~~ ~~2937~~ ~~2938~~ ~~2939~~ ~~2940~~ ~~2941~~ ~~2942~~ ~~2943~~ ~~2944~~ ~~2945~~ ~~2946~~ ~~2947~~ ~~2948~~ ~~2949~~ ~~2950~~ ~~2951~~ ~~2952~~ ~~2953~~ ~~2954~~ ~~2955~~ ~~2956~~ ~~2957~~ ~~2958~~ ~~2959~~ ~~2960~~ ~~2961~~ ~~2962~~ ~~2963~~ ~~2964~~ ~~2965~~ ~~2966~~ ~~2967~~ ~~2968~~ ~~2969~~ ~~2970~~ ~~2971~~ ~~2972~~ ~~2973~~ ~~2974~~ ~~2975~~ ~~2976~~ ~~2977~~ ~~2978~~ ~~2979~~ ~~2980~~ ~~2981~~ ~~2982~~ ~~2983~~ ~~2984~~ ~~2985~~ ~~2986~~ ~~2987~~ ~~2988~~ ~~2989~~ ~~2990~~ ~~2991~~ ~~2992~~ ~~2993~~ ~~2994~~ ~~2995~~ ~~2996~~ ~~2997~~ ~~2998~~ ~~2999~~ ~~3000~~

Financial Editor
TWO shareholder meetings will be held today to start the way for the creation of the Tiger-Sugar company which is expected to control assets and investments worth R568 million and pre-tax profits of R133 million a year.

the first meeting will be held in Johannesburg, where Barlows' shareholders will be asked to approve the share-swap transactions with Old Mutual.

They will swap holdings of C G Smith, PP Cement, Reunert and Lenz and Transvaal Consolidated Lands for new Barlow shares.

In another deal, C G Smith will issue new shares to Barlows who will issue more of their shares to Old Mutual for a 12,6 percent holding in Nampack.

The second meeting, in Durban, this afternoon will be that of C G Smith shareholders, who will be asked to approve the various legs of the transaction.

Romatex

The result of the meetings is expected to be that C G Smith will hold 56,6 percent of Romatex (no change here), 74,8 percent of Nampack and about 70,1 percent of Tiger-Sugar.

The Tiger-Sugar holding is subject to the acceptance level of existing Tiger shareholders.

Tiger-Sugar will hold 70 percent of Tiger Oats, 100 percent of Smith Sugar and the group will hold 65,7 percent of Imperial Cold Storage.

The Smith sugar interests to be placed into the new company include the six sugar mills producing 900 000 tons of sugar a year; estates which grow 1,3m tons of cane; S A Sugar Distributors, which is responsible for selling 80 percent of sugar on the domestic market; Smithchem, which makes various chemicals at Sezela; and Natal Cane By-Products, whose main product is ethyl alcohol.

For technical reasons some of the farms at Sezela and milling assets will not be handed over until the end of C G Smith's financial year in September.

Once the proposals are implemented Tiger Sugar will have 8,6m shares in issue which 'in due course will be listed on the Johannesburg Stock Exchange.'

Capital

A pro-forma balance

DURBAN — Fire destroyed sugar cane on at least 15 farms in the Compensation area yesterday and farmers believe their losses could be as high as R7 million.

A pall of black smoke blotted out the sun over a vast area of the North Coast as the blaze destroyed everything in its path.

Strong winds fanned flames to more than 10 m high and hundreds of farm workers

(3) Sugar
Star *1/9/82*
**Huge fire destroys
R7-m Natal cane**

had to flee their homes.

At one stage the blaze was seen to leap breaks of 150 m.

The fire is believed to have started at 7.30 am near Upper Tongaat. Nearly 12 hours later it was still burning and had swept

through at least 20 km of Natal's prime sugar cane.

Fluctuating winds whipped the flames into huge circles until just after dark when the wind dropped, and firefighters moved in to take control.

One farmer, Mr D B

Clode, saw the inferno wipe out the whole of his farm.

"It's the fire of the century," he said.

"My farm's gone, and I know of at least 15 others," he said, turning his back on the intense heat.

Farmers across the highway who had been unaffected by the blaze, got together with two tractor-drawn fire tenders to keep the fire from leaping a road to a farm and a kindergarten.

Flames leap 150 m breaks as 150 000 tons

is destroyed

Inferno ravages cane farms

1/9/82
Sugar
Mercury

Mercury Reporter

FIRE yesterday destroyed sugar cane on at least 15 farms in the Compensation area, and farmers believed their losses could mount as high as R7 000 000.

A pall of black smoke blotted out the sun over a vast area of the North Coast as the blaze relentlessly destroyed everything in its path.

Strong winds fanned flames to more than 10 m high and hundreds of farm workers were forced to flee their homes.

At one stage the blaze was seen to leap breaks of 150 m.

The fire is believed to have started at 7 30 a m near Upper Tongaat and nearly 12 hours later, still burning, had swept through at least 20 km of Natal's prime sugar cane.

Wait

Fluctuating winds whipped the flames into massive circles, until just after dark when the wind dropped, and firefighters moved in to take control.

One bleary-eyed farmer, who had battled all day and had seen the inferno wipe out his entire farm was Mr D B Clode.

'It's the fire of the century,' he said.

'Whatever we do is of no consequence. It just doesn't help. All we can do now is wait. It moves at such an incredible speed.'

'My farm's gone, and I know of at least 15 others,' he said, turning his back on the intense heat.

One farmer said the fire had passed his farm, only to be turned around when the wind changed, and engulfed his fields.

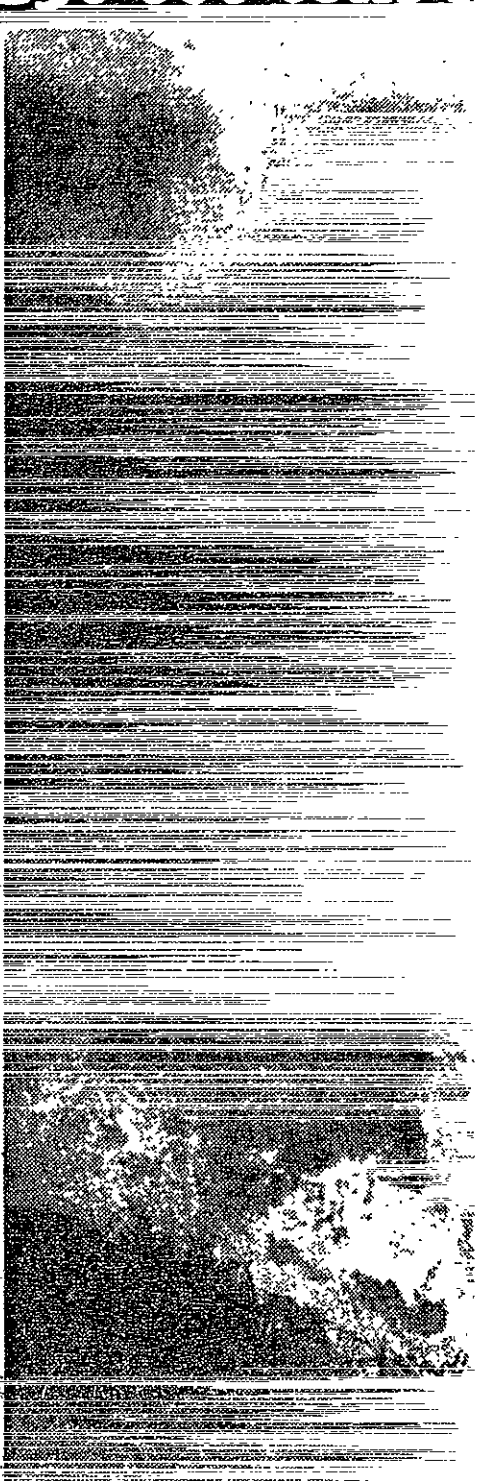

AT THE height of the outbreak milling.

The blaze brought down telephone lines and burned down wooden poles.

Farmers across the highway who had been unaffected by the blaze, got together with two tractor-drawn fire tenders to keep the fire from leaping a road to a farm and a kindergarten.

Mr Noel Marot, a farmer from the sea side of the highway said: 'I've been here 42 years and never have I seen a fire like this. At midday, when the wind was strongest, the fire was leaping breaks of 150 m.'

'It must be the worst fire in the history of the North Coast.'

He estimated that about 4 000 ha had

been affected, and said the chairman of the Tongaat Mill Group Board thought that about 150 000 tons of cane had been destroyed.

Mr Ian Marot calculated that the selling price for cane was R19 a ton and 1 ha produced 100 tons.

Mr Marot said only millable cane would be salvageable - but to be salvaged it would have to be cut within three days.

'All the farmers will have to get together and help those whose farms have been gutted.'

Firemen from Ballitoville had had no reports of injuries.

They were standing by to make sure the fire did not spread to the Umhlali Primary School and a nearby doctor's surgery.

The principal of the school, Mr Danie Pienaar, said the fire began to climb a ridge towards the school during a sports meeting.

'I abandoned the meeting and sent the 200 athletes home. But the fire didn't reach us as the area below the school had already been burned.'

At least one stout farmhouse had been surrounded by flames, but had not been touched by the blaze.

But cane workers living in a nearby compound had fled as their thatched-roofed homes were quickly swallowed up.

A shaken and tearful Mrs Anna Mdezi, helped by friends to move what was left of her household said: 'I have nowhere to go.'

At dusk the drama heightened when the wind again changed direction and a south-westerly guster pounded the area.

The cause of the fire was unknown.

I

Not quite

Handwritten notes on the left side of the page, including "that was the best", "the fire", "the school", "the meeting", "the area", "the blaze", "the compound", "the homes", "the drama", "the area", "the fire", "the cause", "the fire", "the cause", "the fire", "the cause".

Handwritten notes on the right side of the page, including "long term projects", "the school", "the meeting", "the area", "the blaze", "the compound", "the homes", "the drama", "the area", "the fire", "the cause", "the fire", "the cause".

His optimism was backed by Mr 'Pottie' Potgieter of the Tongaat group.

The problem of who went first was decided by the spin of a coin.

'We have only 120 workers. To split them will waste more time than if we cut one farm at a time,' a farmer explained.

Meanwhile, all over the burned properties workers furiously cut, baled and loaded the cane on to tractor-pulled trailers.

When the Mercury visited a siding trailers were queuing at the weighbridge with their four- to six-ton loads while cranes stacked them in the background.

Post Office linesmen were busy re-stringing lines that had been destroyed by Tuesday's fire.

On one section a linesman said he had more than 15 km to re-string — and that it was only a small section: 'It's not yet possible to estimate how much will need replacing.'

Estimates

Yet shepherds were back among the burned cane, watering their stock as if nothing had happened.

The managing director of Hulett Sugar Limited, Mr Dick Ridgway, said yesterday initial estimates were that 170 000 tons of cane had been burned in the Tongaat area.

He said approximately 80 000 tons was millable.

Mr Ridgway added that everything was being done to get the millable cane into the mill, and Hulett's own estates have stopped cutting in order to make labour available to assist the farmers.

The possibility of allocating extra cane to the Mt Edgecombe mill is also being examined.

Police squash cane fire 'arson' report

Crime Reporter

POLICE in Durban said yesterday that they had no evidence to substantiate a newspaper report that Tuesday's devastating cane fires on the Natal North Coast had been deliberately started by political activists.

They also had no confirmation of the report from an un-named North Coast doctor that saboteurs had shot a black 'informer' whom he had treated for a gunshot wound to the shoulder on Tuesday night.

Brig J R van der Hoven, Divisional Security Branch Officer for Port Natal, said yesterday he was satisfied that there was no evidence of sabotage or political involvement in the runaway cane fires.

Spread

'Our information is that an Indian cane farmer was burning his own cane before harvesting when a strong wind came up.

'The fire got out of hand and spread to other canefields,' he said.

He added that the North Coast doctor's claims had not been reported to the Security Branch.

A man, who said he was a doctor but would not identify himself, is reported to have telephoned a Durban newspaper yesterday to say that a black man had come to his house on the North Coast on Tuesday night with a bullet wound to his left shoulder.

The wounded man said he had been shot by a group of men because he had mentioned that saboteurs had been told to burn cane crops in the Umhlali area.

The man had said he was afraid to go to the police for fear of reprisals.

Wound

Brig John van der Westhuizen, Divisional Detective Officer for Port Natal, said yesterday that no shooting incident had been reported to the police on the North Coast on Tuesday night.

'Nor has any doctor reported to the police that he had treated a man for a gunshot wound. If the man is a doctor he is aware that a bullet wound is a reportable injury, and that it is a statutory offence not to report it to the police.'

'If there is any truth in his claim he had better contact the police without delay before he is traced,' he said.

Brig van der Westhuizen said police were looking for several black men who are thought to be suffering from bullet wounds received in a fracas at the Kwa Mashu beerhall when Det-Sgt X Sorji was battered to death by a mob on Saturday afternoon.

Scattered

The detective emptied the magazine of his 9 mm service pistol into the mob before he was killed, and soon afterwards three black men with bullet wounds were arrested.

'If the anonymous doctor did treat a man for a bullet wound, it is more likely that he was one of those present at the killing of Sgt Sorji and that he concocted the story about cane-fire saboteurs to persuade the doctor to treat him without reporting it to the police,' the brigadier said.

Operation salvage for Natal's sugar farmers

21/82 Mercury Reporter Mercury
FARMERS who watched helplessly as 170 000 tons of their cane burned, believe they might be able to rescue 80 000 tons — if they can get it to the mills on time.
They met at a siding during mop-up operations yesterday to discuss the fastest way of getting the cane to the mills.
Mr Murray Farlow, who is in charge of one of the sidings, said: 'We'll get the 80 000 tons off.'

③ ^{Sugar} S A Sugar Association does ^{3/8/82} not speculate in futures'

Financial Editor

The S A Sugar Association does not speculate in sugar futures in any shape or form the general manager, Mr Peter Sale, told a colloquium on the 'World of Futures' in Johannesburg yesterday.

The association, while recognising that speculation was good, in that it augments the volume and liquidity of a market and is beneficial to a "true hedger" says that 'commodity markets are fickle and sugar is no exception.'

Mr Sale said the potential loss was such that they were not prepared to use the futures market for that kind of operation.

The association has used forward exchange cover but again does not 'place the values of its for-

eign currencies at greater risk than is necessary.'

He said the sole purpose for the involvement in the futures market was to establish a price for the sugar they would produce.

As a producer they were assured of supplies the only variable was the date and the 'unknown' price at which the sugar would be sold.

Mr Sale said that the pricing policy was 'to yield a return in South African rands which will be sufficient to cover the costs of production of export sugar.'

The industry had entered the futures market when South Africa left the Commonwealth Agreement in 1961 and assumed responsibility for selling its own sugar.

After first raising offshore funds to fund its

margin requirements during the rapid price rises in the seventies and after exchange rates started to diverge, the industry is also heavily committed in the forward exchange markets in portions of £500 000 at a time.

Mr Sale said the value of the futures market was shown in the 1974-5 world price boom when the sugar price reached £650 a ton and they built up a surplus of R90m which was put into the Price Stabilisation Fund.

The benefits of this 'profit', which could have been much larger, were dissipated by the Government's insistence on two price reductions in the domestic price of sugar.

'The folly of this policy has long since been proven,' Mr Sale said.

Sugarmech 85 Mercury 6 Cyls New tractors cut fuel bills

3-Sugar

A FULL season of transporting cane at Sezela and Illovo has proved the efficiency of special haulage tractors. The new 12-speed models introduced by the C G Smith Sugar group have reduced by one-sixth the fuel used per ton of cane harvested.

The company, which last season produced almost a million tons of sugar, purchased 45 of the new Massey Ferguson haulage tractors (HTs) in early 1984. They were put into action alongside existing eight-speed tractors and by the end of the 1984/85 season had hauled 700 000 tons of cane.

Sezela estate chose the 51 kW MF 275 HT, but Illovo Estate opted for the model 290 HT which is rated at 58 kW.

On trailers

The cane was either transported loose in seven-ton box trailers or in bundles on side-loading trailers. Sezela's 19 MF 275's used just five litres of diesel per hour com-

pared with the six litres per hour of 16 other tractors on the estate.

The output of the two groups of tractors was similar at 13.0 and 12.9 tons per hour respectively, in spite of the MF tractors being less powerful than the others.

Sezela's technical field manager, Peter Braithwaite, said the improved fuel efficiency of the new haulage tractors had saved some R20 000 worth of diesel in their first season.

Our conventional tractors used 20 percent more fuel than the Massey Fergusons for virtually the same amount of work. The MF 275s, being about R5 000 cheaper than the next tractor size upwards, were in effect more productive than their stablemates. In fact, we saved R100 000 at Sezela by going for the less powerful but equally productive model 275,' said Mr Braithwaite.

Encouraging

In 1983 the eight Sezela sections harvested 415 278 tons of cane and used 237 703 litres of fuel to move it from the field to the zones (1,74 tons per litre).

The following year (1984) when just over

half the tractor fleet was 12-speed Massey Fergusons, the crop was 562 379 tons and the fuel used totalled 216 944 litres (2,59 tons per litre).

Peter Braithwaite says that these are encouraging figures, but they are 'sensitive' to the quality of the crop — 1984 was a good year and the heavy cane more readily transported.

At Smith Sugar's Illovo estate almost all the cane is transported to the zones in seven-ton box trailers.

Eleven of the 15 haulage tractors are the new MF 290 HTs and in 1984 the estate averaged 17,2 tons per hour compared with 15,1 the previous season. The better crop, trailer changes and other factors will have contributed to the improvement, in addition to the efficiency of the new MF tractors.

Fleet reduced

Illovo has, for example, improved overall efficiency so much that it has reduced its tractor fleet from 24 in 1977 to 15 in 1984, while the harvest rose from 186 000 tons to 267 000 tons over the same period.

Robin Campbell, agri-

cultural manager at Illovo, said he remembers when cane was hauled at an average of six tons per hour.

'Today it is transported at up to 20 tons per hour. Our agricultural engineers produced evidence and put forward proposals, Massey Ferguson did their homework and came up with the right gearbox in the right tractor — and now we are reaping the rewards.'

Malcolm Hatley, a qualified agricultural engineer, said driver response was very favourable to the new MF tractors.

The men quickly discovered the ease and speed of synchronesh gear changes.

At Sezela, section manager Nigel Hawley said haulage driving was a monotonous and tiring job. He and his drivers welcomed features that improved the working situation — such as the power steering on the MF haulage tractors, the easier gear changes, and the comfortable seat.

'We paint the drivers' names on the tractors. They take pride in their machines, and the MF men are envied by the others,' said Mr Hawley.

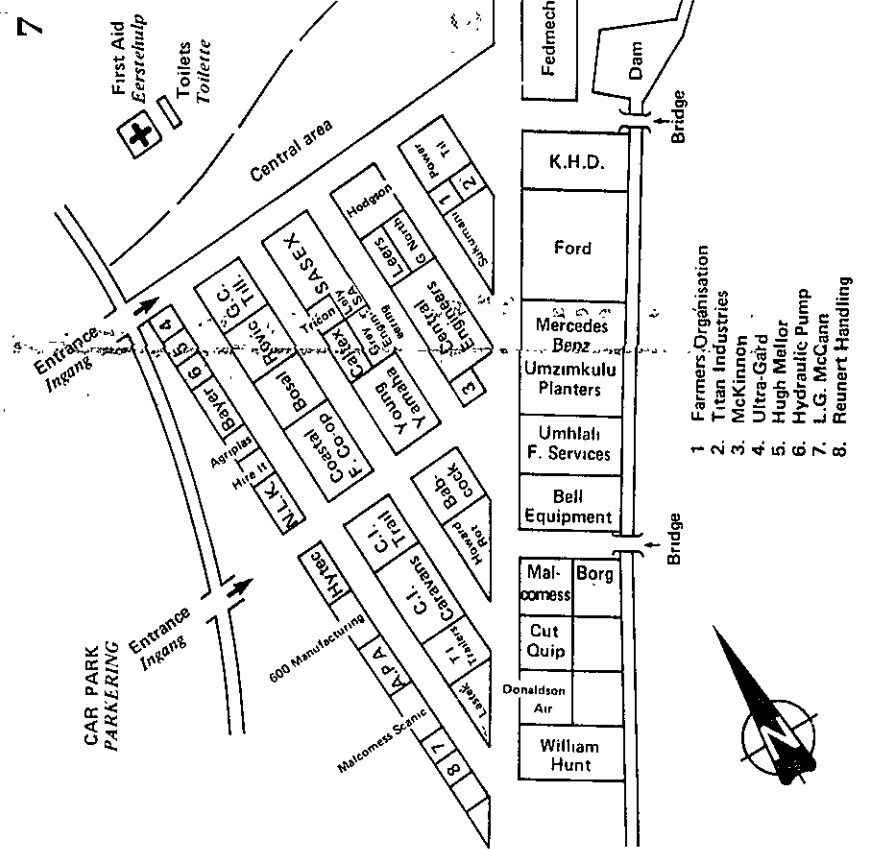
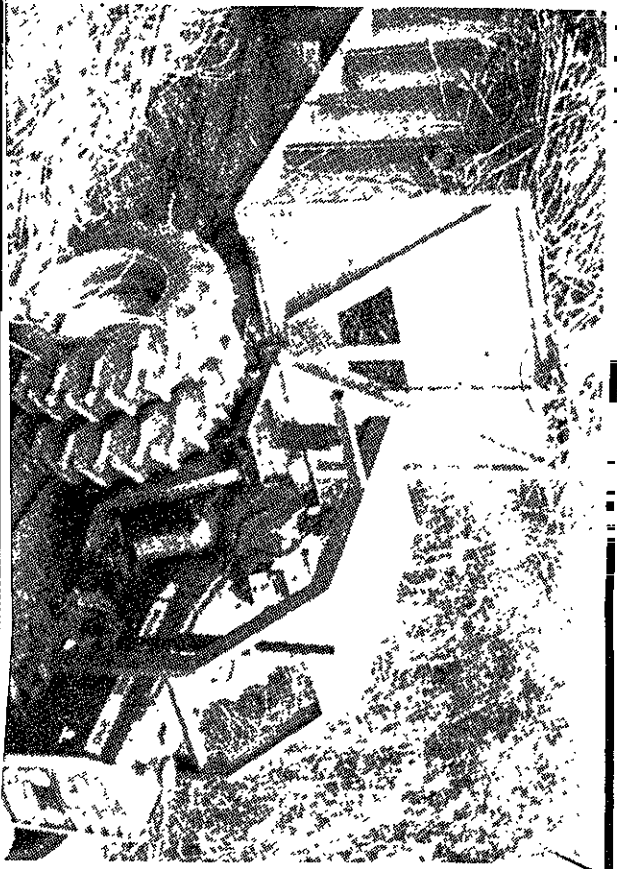

SASA Experiment Station

7

would have brought the industry R40m in 12 months. This would have made the job of financing the anticipated deficit much more manageable. In addition, he claims, it would have been a "one-off measure to allow the industry to overcome its short-term difficulties."

In view of that it may seem strange that Sale believes it is in the industry's own longer run interests to keep the domestic price of sugar as low as possible over the long-term. The domestic market represents the industry's biggest offtake (1,2 Mt as against 0,85 Mt on the export market) and the future of the industry depends on a stable domestic market.

In addition, the industry is concerned about the inroads being made into traditional sugar markets by alternative sweeteners, especially high fructose corn syrup (HFCS), a sweetener derived from maize starch. Although HFCS is not widely used in SA, Sale says sugar prices have to be kept low "so that we do not encourage any additional competition."

At R423/t, the domestic sugar price is more than double the current world price. There have been times, like the late Seventies, when the world price was £400/t, when the reverse was true.

The biggest user of sugar on the local market is the soft drinks industry. President of the Federation of Soft Drink Manufacturers, Hennie Viljoen, says the industry managed to absorb some of the costs from the last sugar price increase in March. But, he adds, "there is no way we could absorb another increase. We would have to seek relief from the Price Controller."

Substitution bogey

Illustrating the difficulties the industry would have in this regard, Viljoen notes that soft drink prices were only increased last month — largely as a result of the last sugar price rise. There is a popular misconception, he says, that HFCS cannot be widely used in the soft drink industry as a substitute for sugar. Viljoen says there can be a 50% HFCS substitution in all cola drinks (about half the industry's production) and a 100% substitution in the rainbow flavours.

While he admits that HFCS is not being used in soft drinks at present, Viljoen says "any further increase in the cost of refined sugar makes the use of alternatives just that much more feasible."

More ominously, Viljoen notes that feasibility studies into the conversion of bottling plants to the use of HFCS are already "far advanced." One possible supplier of HFCS is African Products (AP), which already makes glucose from starch. The high cost of SA maize has so far prevented AP from going into large scale HFCS production. But with SA's huge maize surplus, the possibility is becoming increasingly attractive.

That the sugar industry takes the threat of alternative sweeteners seriously is clear from the fact that it recently commissioned

new bulk storage silos in Germiston, which will streamline the delivery of sugar to industrial users.

Essentially, therefore, the sugar industry is caught between pincers. It wants a rise in the domestic sugar price to reduce its deficit, despite the world sugar mountain, which suggests a lower price would be more appropriate. But it does not want to price itself out of a market being attacked by artificial sweeteners.

There remains a possibility, too, that government might decontrol the price of sugar. That would encourage sugar imports and bring down sharply the domestic price.

To prevent that, the sugar industry, a large employer and earner of foreign exchange, wants protection from imports. It

PRINGLE AWARD

Peter Wilhelm, a *Financial Mail* senior editor, has won the English Academy of Southern Africa's 1982 Thomas Pringle award for the category "Play, book, film and television reviews."

In announcing the award, the academy paid tribute to Wilhelm's generally high level of reviewing in the *FM*, and singled out his review of Stephen Gray's *Caltrap's Desire* in particular. It also commended his reviews of J M Coetzee's *Waiting for the Barbarians* and Achmat Dangor's *Waiting for Leila*.

Wilhelm, whose duties include editing the *FM*'s Current Affairs section, is the author of several books. The presentation of the award will be made at a ceremony in Johannesburg in November.



wants freedom to increase the domestic price, without the discipline of world competition, because it believes itself to be "strategic."

Nor can it hope to sweeten export earnings by participating in government's export incentive scheme, thus pushing its burden on to the taxpayer via a back door. The reason is that it does not qualify as at times it sells under a quota system. Incentives would not, therefore, enable it to expand its market share, a prerequisite for this type of help.

The world sugar market is a complex one, subject to enormous swings in demand. Yet it would be foolish to conclude that the local sugar industry is in trouble for any other reason than, despite its best efforts, its inability to escape the discipline of world markets.

The volume of actual or potential production is such that the consumer and/or taxpayer cannot be expected to match large differences between the world price and the SA price. Moreover, a high domestic price undermines the competitive position of sugar-based exports from SA. Further, it encourages substitutes.

What the industry should be trying to negotiate for itself now is an understanding that when the world price rises, it should be allowed to take advantage of the increase, in the same manner that exporters of base minerals do.

No subsidy

There is no point in having an industry that continuously has to depend on subsidies. There are other means it can use to help stabilise earnings. When the price is high, it can build a stronger stabilisation fund to use when the price is low. Or it can seek long-term contracts with domestic and foreign consumers or it can hedge in futures markets.

There is really no case for a strategic sugar subsidy in SA, any more than there is one for copper. The price should therefore be de-controlled and any form of protection withheld. If it is true that the world price of sugar is consistently below the SA price (on a cif basis) then we need a smaller sugar industry to look after domestic demand and marginal land could be turned to other use. For if sugar does not pay in the long-term, then the industry cannot help but cut back its productive capacity.

To keep productive capacity high and gamble on quotas to ginger up flagging earnings is all very well. But then the industry must not expect SA consumers to help it foot the bill, through an artificially high administered price, when its judgment has been found wanting.

It is of considerable strategic importance to have a trim, soundly financed, competitive and profitable domestic sugar industry. Yet this is surely impossible unless the SA industry accepts foursquare the discipline of world markets. Anything less undermines the local industry strategically.

KwaZulu cane crop down

Mercury
African Affairs 2/1/82
Correspondent

THE KwaZulu cane crop this year is likely to be almost 20 percent below the estimated 1 500 000 tons as a result of the current drought, according to the region's Secretary of Agriculture and Forestry, Mr

Hein Ferreira.

Mr Ferreira said it was expected that the cane crop would drop by at least 200 000 tons.

He described the drought in KwaZulu as extremely serious and said no rain whatsoever had fallen in the region during

August.

Mr Ferreira said water was in short supply in areas such as Ubombo, Ingwavuma and Nongoma.

However, it had not become necessary to cart water as a result of the campaign by the KwaZulu Government and the South African Sugar Association to sink boreholes throughout the area.

Mr Ferreira said KwaZulu had drilled 400 boreholes in four years and the sugar association had provided 156 in two years.

Black and white farmers throughout Natal and KwaZulu are complaining about the severity of the present conditions.

③ Sugar

Indian sugar farmer gets Govt ultimatum

19/8/88 Mercury Reporter

AN INDIAN sugar farmer on the Natal South Coast has been given an ultimatum by the Government to dispose of his shares in a company owning a farm in a whites-only area near Port Shepstone or they will be forcibly sold.

Mr S P Pillay has sought the help of the South African Indian Council to make ur-

gent representations to the Minister of Community Development, Mr Pen Kotze, to reconsider the ultimatum.

Mr Pillay was given six months in which to dispose of his shares or action would be taken against him in terms of Section 41 of the Group Areas Act, which gives the minister the right to sell the shares.

Mr Sewsunker Ramphal, the SAIC member for the South Coast, told the Mercury yesterday that he was deeply upset at the Government action against Mr Pillay in the

light of utterances by senior Cabinet ministers that the Government was moving away from discrimination.

The ultimatum follows pressure from the Paddock and Plains Farmers' Association, some of whose members were opposed to the acceptance of the Indian farmer into the Paddock area.

Mr Ramphal, who is also president of the Natal Indian Agricultural Union, said Mr Pillay bought the farm from a deceased estate.

'It was more a gentleman's estate than a viable, income-producing farm. It was in a bad way when Mr Pillay took it over.'

'No one else was interested in buying the farm at the time, in spite of it being offered to neighbouring farmers and being widely advertised.'

Mr Ramphal has been approached by Mr Pillay to make representations to the Government on his behalf.

He said the farm was bought by a company called F W B Farms, with a white Port Shepstone estate agent holding 51 percent of the company's shares and Mr Pillay 49 percent.

Because the farm is now viable, Mr Pillay wants to take transfer of it in his name.

'This latest ultimatum from the Department of Community Development has put a further damper on the spirits of Mr Pillay,' Mr Ramphal said.

R3,5 million
sugar crop
up in smoke

HOW A DEVIL WIND UNLEASHED A MONSTER

By STAN MAHER

THE man who accidentally started Natal's monster cane fire which blazed through 175 000 tons of the crop worth R3,5 million this week told the Sunday Tribune how it happened.

He is Mr. Krish Govender, 32, a R188-a-month relief clerk at C. G. Smith's Sampoya cane loading station near Shaka's Kraal, on the Natal North Coast.

He told the Tribune that the blaze, which devastated 35 farms during its 15 km trail of destruction to Umhlati, started after he fired a pile of trash.

'I lit the rubbish fire that started it'



Krish Govender: he started the fire

Mr. Govender said he lit the trash — dry cane leaves — on the orders of his supervisor, Mr. Alan Simpson. The fire was made in a yard routinely used for the burning of rubbish.

"We were told to put the fire in at about 8.45am on Tuesday," he said. "By 9am only smoke was coming out from the trash and I went to weigh loads of cane."

"Fifteen minutes later, Fanilozi, a labourer from the area, started near

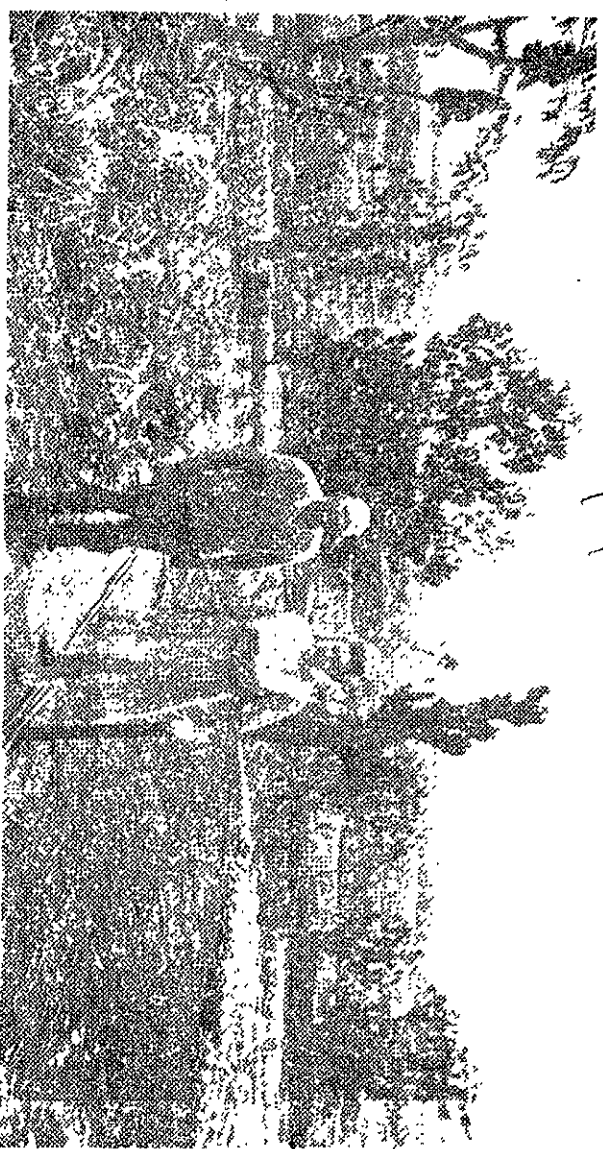

Noel and Hannie Pearce: an incredible disaster

and rolling, as labourers hurried to reap the scorched crop. Farmers pleaded ignorance about the cause of the fire when the Sunday Tribune spoke to them. Two Shaka's Kraal group were served by Gledhow.

Mr. Noel Pearce and his wife Hannie, lost 106 cows, which were smoke blackened and half roasted by the blaze.

Sax Fitchat: almost lost her house



Bruce Hulett: lost 200 litchi trees



Denise Thompson: lost 6 000 tons



Peter Goore: amazing no one was killed

Mr Pearce pointed to a 17-metre tree above the roof of their house, whose leaves were scorched by the heat. The asbestos walls of his garage were alight as the cane fire cracked only 15 metres from their farmhouse, he said.

"I have been in the sugar business a long time, but I have never seen anything like it," he said.

Mr Bruce Hulett, who lost 2 200 tons of cane, told how he radioed his wife to be ready to abandon their home, as "fireballs" shot over the road and set alight trees on the far side.

"About 200 of my 600 litchi trees were burned as well as five acres of banana trees which were not insured," he said.

Mrs Denise Thomson said that she and her husband Peter had had 6 000 tons of cane scorched — "every stick. All I have left are my flowers."

The fire completely defeated all efforts to contain it and burned itself out only when the wind dropped and it reached a main road.

Cane insured by other companies could bring the total up to 175 000 tons, farmers said. At last year's price of R20 per ton, that makes the crop worth about R3,5 million.

Farms which normally send 80 to 200 tons a day to the mills during the cutting season, are suddenly faced with 6 000 or 9 000 tons of scorched cane which has to be cleared within 10 days — or be lost.

Farmers were anxiously scanning the skies for rain — rain they had been praying for to end the long drought. Now, the rain, if it comes, will spoil the scorched harvest.

Mrs Fitchat described the fire as being driven by "a devil wind." She told how she sat in her car on the main road, unable to drive to her house, as the fire raged above her head on one side of the road.

"The fire raged along the hills, crossed the tar road, burned the Claytons' place then jumped back over the road again. It was completely unpredictable

Sampoya station, then each added hurriedly: "But I don't want to talk about that."

But African tractor drivers were already telling the story of how it had flared up in the grip of a huge wind.

Sugar company officials investigating the fire were tight-lipped and hostile when the Sunday Tribune made inquiries at Sampoya station.

Mr Simpson repeatedly refused to discuss the fire.

Mr Govender's version of how the blaze started was backed up by farmer's wife Mrs Sax Fitchat, whose thatched house narrowly escaped being razed.

"Mr Simpson, who works for Gledhow, wanted the workers to tidy up the trash and so he told them to burn it," she said.

"My husband was talking to our induna and they saw the men put the fire into the trash. Next minute this devil wind sprang up and took it into the cane. It was the most incredible sight."

About 4 000 hectares

was a fire in the grass only 50 metres away. The flames were waist high. Before we could do anything there was a very strong wind and it took the fire into the bush.

"Within five minutes the whole hillside was alight and the wind took it into the cane.

"I called Mr Simpson on the radio and also told the supervisor at Shaka's Kraal, Mr Seewa Naidoo."

But it was too late.

Farmers and labourers who rushed to help found they could not get near the fire, a farm manager, Mr Leigh Giles, said.

"We had everything against us — dry cane after a long drought and a hot Berg wind," he said. "I have never seen a cloud of black smoke like that. It looked as if oil was burning."

"The wind was so fierce that it was dangerous even to backburn against it, so we just cut breaks and watched."

This week, the results were plain to see. The hills around Shaka's Kraal stretched black



**Sugar
farmers
advised
to 'band
together'**

3 Sugar
Mercury
20/9/82

African Affairs Reporter
ZULU sugarcane growers at Ndwedwe who are dissatisfied with the Sukumani Company, which cultivates cane on their land for a fee, have been advised to club together as a company and seek financial aid from the KwaZulu Development Corporation (KDC).

Sukumani was formed by the Tongaat Group to promote the interests of Zulu cane farmers by ploughing, planting, and caring for the cane until it is taken to the mill.

The company then deducts all the expenses incurred and pays the balance of the money to the land owners. But some farmers have claimed that they end up with nothing. Mr W.T.V. Luthuli, chairman of the KwaZulu Cane Growers' Association, said his association had not been informed of the farmers' grievances and would be prepared to discuss the matter with them.

Mr Abel Mhlongo, chairman of the Ndwedwe Cane Growers' Association, has however, suggested the small growers should club together and ask for financial aid from the KDC.

7/11/82 (3) sugars

SUGAR INDUSTRY

Waiting for Rorich

The report of the Commission of Inquiry into the Sugar Industry is expected to be released within weeks. But industry sources believe that many of its proposals may be difficult to implement.

The detailed recommendations are now with Industries, Commerce and Tourism Minister Dawie de Villiers.

Those who have glimpsed early drafts say it contains no major surprises, and that the most controversial recommendations deal with expansion and transport methods.

"We could have a few problems here," maintains one sugar man. "Not so much with the recommendations themselves but their implementation. It appears that a lot

of further negotiations will be required."

He says the cane transport system is highly complex and is covered by a multiplicity of agreements between growers and millers; the commission's approach has been to wipe the slate clean so that a new start could be made.

"It's not going to be that easy to unscramble that egg," he says.

The commission was appointed in March last year. According to chairman Dr Athol Rorich, the main focus of the report is on expansion in the industry. But cane transport, marketing techniques both internally and externally and ethanol production from sugar cane were also dealt with.

Rorich says "I think we have come up with some constructive ideas and hope they will make a positive impact on the development of the industry."

Expanded sugar production proposed

Financial Editor

Mercury 16/10/82

SUGAR mills will pay for cane transport from next May if one of the major proposals of the Rorch Committee of inquiry into the sugar industry were carried out. They will have to buy the cane from the growers.

The second major proposal which is part of the long-proposed industry is a 10-year expansion programme.

The chairman of the Cane Growers' Association, Mr Gordon Hughes, said he hoped that the government had devoted more thought to social and strategic requirements than to economic considerations.

He said that the ISO would be a major factor in the expansion of the industry and a great deal of attention would be given to the local industry which would be expected to meet the growing expensive new mills and land brought in.

Mr Gordon Hughes, chairman of the Cane Growers' Association, said he hoped the government would give more thought to social and strategic requirements than to economic considerations.

His committee report was that the government should consider the desirability of expanding the industry and cane transport costs.

cane transport costs.

'I see many problems arising from the revocation of certain of the present agreements between growers and millers, and growers and third parties which in some way or another are connected with cane transport, and from the concept of compensation having to be paid to those who lose and recovered principally from those who stand to gain.'

Mr Jones said there would be pressure to re-allocate cane deliveries to 'nearby' mills resulting in surplus capacity at some and the need for costly expansion at others.

The Director-General of Industries, Commerce and Tourism, Dr T A du Plessis, who has handed the report to the Government, said it 'concluded that over the next 10 years, room for limited expansion existed and it was recommended that this be allowed in KwaZulu, KwaZulu, Transkei and the Eastern Transvaal Lowveld as well as assisting small commercial cane growers.'

Mr R K Ridgway, chairman of the South African Sugar Association, welcomed the release of the report. He said the committee had been appointed 18 months ago and had dealt with the desirability or otherwise of expanding the industry and cane transport costs.

From an initial examination it was apparent that some of the detailed

recommendations could prove difficult to implement and some of the problems arising from the main recommendations had been left to the sugar industry to solve.

It was necessary for the industry to give detailed consideration to the report and then to discuss the matter with the minister.

Mr Ridgway said it was very possible that the two sections of the industry — the millers and the growers — could have differing opinions on certain of the recommendations, and these views would have to be discussed before any decisions could be reached.

Mr Jones said the report contained recommendations which could have far-reaching implications for the growing and milling sections, but as the millers had not yet had the opportunity of considering the recommendations he was unable to make any official comment.

Speaking on behalf of a broad section of the millers, he believed that the committee had taken a realistic attitude as far as expansion was concerned in that their proposed plan was to be phased in over a 10-year period which would cause the minimum of disruption to the existing industry.

He said there were particular aspects about which he had strong res-

ervations.

Unfortunately the expansion recommendations could not have come at a worse time, when the world was in an over-supply situation, with large stocks overhanging the market and prices at disastrously low levels.

The International Sugar Organisation appeared helpless to remedy the present situation and it was essential that a new agreement be negotiated at the earliest opportunity. To have any real effect, this should include the EEC, and also provide for larger stockholding commitments in addition to quotas.

'I would be inclined to defer commitment to any major expansion plan until we know the outcome of the deliberations of the ISO, with particular regard to the size of the quota that South Africa would receive,' Mr Jones said.

Mr Gordon-Hughes said that when evidence was submitted to the committee, the Cane Growers' Association had opposed large-scale expansion into new areas.

Since then, local market sales had been much lower than expected and conditions in the world market had also deteriorated.

World sugar stocks were more than 34 million tons, which was 10 million tons above normal. Production still exceeded consumption and the result was that export prices were disastrously low.

At present, all sugar ex-

porting countries, through the ISO, were examining ways of further curtailing production to restore export prices.

His association felt that the committee's proposals on cane transport could prove to be in the long-term interests of the industry, but much work was required before a final conclusion could be reached, especially as the proposal represented such a drastic change.

Numerous important details concerning the manner in which the proposals were to be implemented remained to be clarified and it was quite impossible to give an assessment of the scheme before this had been done.

A key issue, fundamental to the possible implementation of the scheme, was whether the minister would be prepared to override existing legal agreements and rights which growers had with their millers, especially as in some cases Government was the third party involved in establishing these rights.

The association would be considering the report in detail in anticipation of discussions with the minister.

Dr du Plessis told Sapa in Pretoria that the Sugar Association would be given an opportunity to study and comment on the report before the Government made any decisions on the recommendations.

The most important findings and recommendations concerned the expansion of sugar production and the method of payment and recovery of cane transport costs.

The existing method of payment and recovery of cane transport costs had caused a great deal of controversy and dissatisfaction over the years.

'Because of conflicting interests, attempts to improve the position have hitherto met with little success, with the result that the cane transport costs, which represent a substantial portion of total costs, have resulted in the overall cost structure of the industry being higher than it needs to be.'

Sugar 17/10/92 report growth plan badly timed

By Mike Pierson
Finance Editor

THE long-awaited report of the committee of inquiry into the sugar industry, which has taken years to compile, was this week submitted to the Minister of Industries.

It contained two main recommendations — on the phasing in of an expansion plan over a 10-year period, and on cane transport.

But, ironically, the industry experts say the recommendations covering expansion could not have come at a worse time.

Says Frank Jones, chairman of the SA Sugar Millers' Association: "The world is in an over-supply situation, with large stocks overhanging the market and prices at disastrously low levels.

Furthermore, the International Sugar Organisation appears helpless to remedy the present situation. It is essential, therefore, that a new agreement be negotiated at the earliest opportunity and to have any real effect must include the EEC.

"I would, therefore, be inclined to defer commitment to any major expansion plan, until we know the outcome of the deliberations of the International Sugar Organisation with particular regard to the size of the quota that South Africa would receive."

On the question of cane transport, Jones said his initial reaction was that the committee had not provided solutions to many of the major problems which would arise both now and in the future, should their proposed scheme be introduced to make growers fully responsible for all cane transport costs.

Lawrence Gordon-Hughes, chairman of the SA Cane Growers' Association, added that it was not an appropriate time to commit the industry to a 10-year expansion programme of major proportions.

"It appears the committee has devoted more attention to social and strategic requirements than to economic considerations."

SHS 18/10/52

Sugar report given favourable reaction

3 sugars

First reaction to the report of the committee of inquiry into the sugar industry seems positive but with reservations about plans for a 10-year expansion programme.

The committee was appointed about 18 months ago to establish whether it would be desirable to expand the industry and to investigate the method of handling cane transports.

Mr R K Ridgeway, Chairman of the Sugar Association, said he welcomed the report, but some of the recommendations could prove difficult to implement.

Dr T A du Plessis, Director-General of the Department of Industries, Commerce and Tourism, announced the committee had made two important recommendations.

The first was that limited room for expansion existed, which should be allowed in

kwaZulu, kaNgwane, Transkei and in the Eastern Transvaal Lowveld.

The second was that a new transport scheme be introduced in which cane growers would be responsible for the cost of transporting their cane to the mills.

Assistance to small commercial cane growers had also been suggested by the committee, he said.

The chairman of the Sugar Millers' Association, Mr F R Jones, said that the recommendations covering expansion could not have come at a worse time — when the world was in oversupply with large stocks overhanging the market.

Reuter reports that the Dominican Republic has decided to take its sugar off the international market until prices recover from their current 10-year low.

air and

BEHRMANN

short position
Other bullion sources said the initial rally from the low \$300s to \$500s was fuelled by major short covering from Saudi Arabia.

According to Mr James Sinclair, a New York broker, the Saudis covered 25 000 contracts, equivalent to 2 500 000 ounces of gold on Comex, the New York futures exchange. There was also widespread covering on other markets.

Short selling by wealthy floor traders in New York and Chicago when the price dropped below \$400 and their covering also helped the rally.

Although most dealers described the bullion market as professional, the general view was that the Federal Reserve Board had turned towards reflation.

The president of the Federal Reserve Board, Mr Paul Volcker, said the central bank was unlikely to ease credit dramatically soon because of worries over inflation.



Mr Ivan Boardman has been appointed divisional financial manager of Kohler's flexible packaging division.

Greenings change

By NEIL BEHRMANN

LONDON. — London & Midland, Industrial, a large UK public company is buying several companies, including one based in South Africa from another large British public company, Johnson & Firth Brown.

The South African company which will change hands is Greenings (SA) (Pty). It manufactures medium and fine woven metal cloth, stainless-steel wedge wire screens and high-tension woven screens for mining applications and metal belts.

nom 18/10/82

Cubans in market for sugar imports

THE Cubans are in a dilemma, reports Afro-mar.

They have been caught short on sugar commitments to the Soviet Union as well as China, and they may have to import about 100 000 to 120 000 tons of sugar from the free market, mostly South American and Caribbean sources.

Sugar is also thought to have been arranged from Mauritius to Cuba.

The Soviet Union is buying more than 7 500 000 tons of wheat from Canada, to be shipped from both Pacific and eastern ports.

This is good news for owners, although it is known that the Russians have been quietly taking tonnage to cover cargoes up to the middle of next year.

The Americans have abundant supplies of wheat and storage is becoming a problem for them. It is suggested that this could mean further large grain sales by the Americans.

Australia's wheat crop is expected to be halved in the current year, being the lowest since 1972 at about 8 500 000 tons.

Atlantic rates seem to have held steady and on some early positions slightly better rates have been seen. For instance, in the coal trades 80 000 tons was fixed from Hampton Roads to the Continent at \$4.50, but an earlier vessel obtained \$4.95 for the same business.

The Chinese have been taking fertiliser out of the Continent and have some sugar inquiry out of Cuba, which the Cubans will be able to find.

The Far East at best has remained steady, but conditions are such that many

THE WORLD SEA-FREIGHT SCENE

owners prefer to ballast out of the Pacific to the US Gulf to take advantage of better rates.

In the time-charter section 'tweendeckers have not met with an improvement.

A Freedom-type vessel was taken for a trip from Japan to the Continent at \$1 950 daily. A liner company took three 12 000 multi-purpose type vessels able to lift 400-ton containers at \$4 450 a day for up to a year's trading with the option of up to a further year at \$5 450 daily.

The South African market showed few signs of buoyancy last week, and charterers in some cases were to whittle away at poor rate levels. Not much activity was seen in the grain sector, although it is thought that there was some interest in cargoes to the Far East.

Coal charterers fixed 112 000 tons from Richards Bay to Le Havre for an early position for which they had to pay the higher rate of \$7.60. A contract for the movement of 6000 000 tons from Richards Bay to Denmark was quoted with shipment over 1983. There was also some small cargoes quoting to the Far East.

Few fixtures were reported in the ore trades, but a cargo was thought to have been arranged from Port Elizabeth to France. A cargo of 10 000 tons of chrome ore was fixed from Maputo to Japan at \$13.50.

Some interest was noted from SA time charterers for trips to various destinations.



Mr Jannie Snyman will become a general manager of Sanlam in 1983.

Joint announcement

by
Seardel Investments
("Seardel")
and
Dugson Holdings
("Dugson")

Seardel and Dugson concluded pursuant to 1 a consortium of p The Johannesburg Dugson's issued consideration of R requirements of the all minority ordina 2. Seardel simultaneous underlying trading

The abovementioned conditions precedent which it is anticipated purchase consideration will be paid immediately

In terms of the requirements will be suspended from the commencement A circular to Dugson proposed transaction

By order of the board
Seardel Investments
A. D. Jacobson
Secretary

By order of the board
Dugson Holdings
A. M. Goldstein
Secretary

Johannesburg
15 October 1982

A.F.E. LINE (HONG KONG) LTD

ROOM 2310, MELBOURNE PLAZA, 33 QUEENS ROAD, CENTRAL, HONG KONG. TELS: 5-255191-4 TELEX: 61101 EXPOS HX

"EXPRESSHIP" MONTHLY CELLULAR SERVICE

SAILING FROM		EXPECTED ARRIVAL / SAILING			EXPECTED ARRIVAL	
YOKOHAMA	KEELUNG	HONG KONG	DURBAN	CAPE TOWN	SINGAPORE	HONG KONG
12/10	17/10	19/10	13/11	18/11	13/12	24/12
2/11	7/11	9/11	1/12	5/12	22/12	29/12

SUBJECT TO ALTERATIONS WITHOUT NOTICE

PLEASE — LOADING DURBAN AND CAPE TOWN FOR HONG KONG, JAPAN, TAIWAN AND KOREA.

GENERAL AGENTS IN SOUTH AFRICA

JOHANNESBURG P.O. Box 1044 Tel: 26-2961 Telephone 27-210 Telephone 25-290 FAC 45704	DURBAN P.O. Box 1077 Tel: 33-2961 Telephone 33-210 Telephone 33-290 FAC 45704	CAPE TOWN P.O. Box 1044 Tel: 26-2961 Telephone 27-210 Telephone 25-290 FAC 45704
---	---	--

HLH protest

HLH has taken issue with a report in Business Mail on October 5.

The company says "Firstly, HLH did not lay blame on Blajohn for its performance during the six months to August 1982, and both our interim announcement plus accompanying press release made this clear — all our major divisions had operated below their initially planned levels. To single out our only listed subsidiary as carrying the blame for this group performance is unfair and inappropriate.

"Secondly, to infer in the second paragraph of the report that certain members of Blajohn's senior management 'elected to retire' as a result of 'management troubles' is both misleading and mischievous. The two individuals in question, having reached retirement age (as stated in the interim announcement), had elected to retire on a structured basis, with management continuity assured. The statement that any other reason could be ascribed to their departure has caused considerable unhappiness and aggravation."

Barter deal



try that more land be put under cane.

Sasa says the existing quota land is sufficient to meet SA's annual production target, and that additional production is likely to go unsold on the depressed world market and merely add to existing stockpiles. Further, Sasa maintains that this is a most unpropitious time to expand. A new International Sugar Agreement (ISA) is due to be signed next year and member countries have been attempting to discipline producers to help reduce the 34 Mt world sugar surplus.

SA already faces a 15% quota cut in terms of the current ISA. Unless the world surplus is brought under control, further restrictions could be imposed.

Says a Sasa member: "How can we, at a time like this, announce an expansion programme?" Sugar industry sources argue that expansion plans should at least be left in abeyance until a clearer picture emerges of the international sugar scene.

But in its report the committee concludes that there are compelling social, economic and political reasons why the expansion of cane growing, particularly in the homeland regions, should be encouraged. It suggests that the industry has the capacity to absorb an additional 320 000 t/year and recommends that this production come from new quota allocations to small growers in areas such as KwaZulu, Mangete, Kangwane, Transkei, and the eastern Transvaal.

The committee and Sasa differ on another important point. Sasa maintains that if there is to be growth it should be concen-

FM 29/10/82
SUGAR (3) Sugar
Planters protest

The South African Sugar Association (Sasa) is unhappy with the recommendation of the Committee of Inquiry into the Sugar Indus-

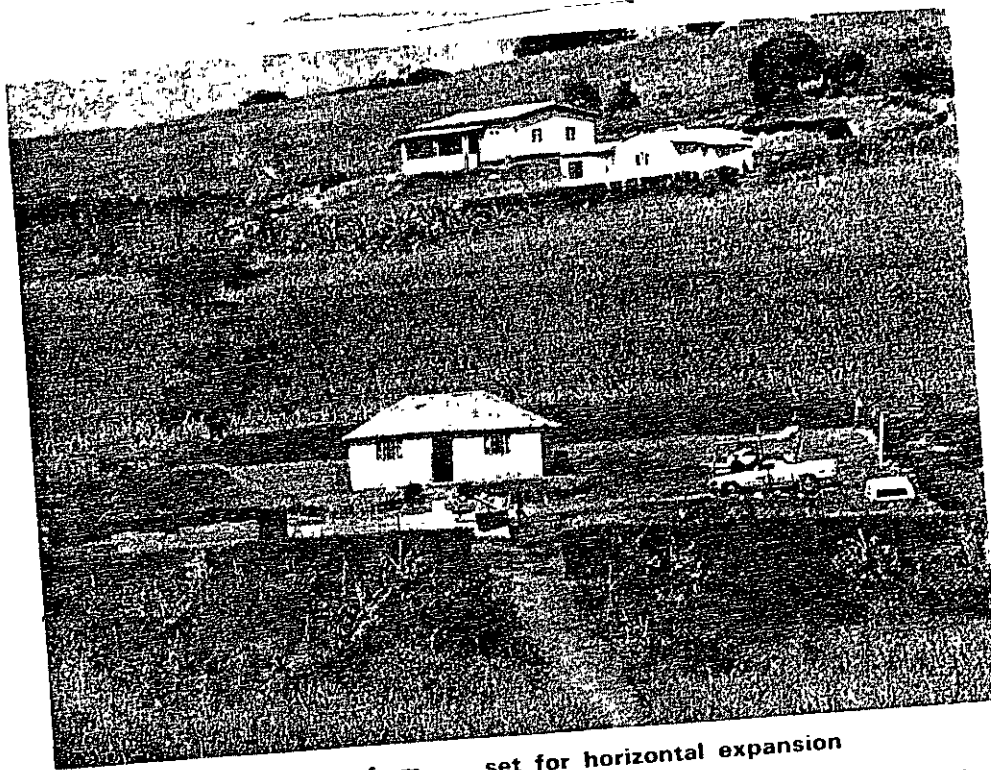

Black sugar farm ... set for horizontal expansion

trated on existing land where there is already spare milling capacity. Taking a diametrically opposed view, the committee feels that "horizontal" expansion should be encouraged in the granting of additional cane quotas, and that "vertical" expansion, or increased yields on existing quota land, should be discouraged. The rationale for this is ostensibly that new quota allocations will bring improved employment opportunities and greater prosperity to the rural regions. Though they can see the political benefits, established growers are not convinced that the committee's argument is economically sound. For one thing, it means that restrictions are likely to be placed on their own growth to encourage new cane growers. Says a leading grower: "We cannot see why the most efficient and cost-effective sector of the industry should be penalised in this way."

A consistent allegation by those who submitted evidence to the committee was that Sasa was being too conservative in its approach to the expansion issue — a view that the committee supported. It charged that Sasa had overestimated the productive capacity of the industry over the next decade by 118 000 t/year and had underestimated local sugar consumption by 23 000 t/year. This, the committee argued, would entitle a limited expansion in the industry. The balance of the 320 000 t it recommended would accrue to new growers via restrictions placed on existing growers.

Although not entirely enthusiastic about the committee's findings, Sasa says it is pleased that the proposed expansion is to be phased in over a 10 year period and that government will consult with the industry before the plans are implemented.

Sasa GM Peter Sale says the various sectors of the industry will study the report in

detail before making direct representations to the minister.

On the question of accommodating the various interest groups, he says. "The association will always do what's best for the industry."

Mills sack 1 000 strikers in food allowance dispute

Labour Reporter

ABOUT 1 000 striking sugar workers were dismissed yesterday after three days of wildcat strikes at six Natal sugar mills.

The strikes began shortly after a meeting of the sugar industry's industrial council when negotiations deadlocked over a revision of a food allowance.

and Mount Edgecombe mills, the independent Umfolozi mill and Premier Milling's Entumeni mill downed tools at the weekend.

Strikers from Mount Edgecombe and Felixton mills had returned to work by yesterday's deadline and Umfolozi mill workers were due to return last night.

But about 1 000 workers from Amatikhulu and Darnall mills had not returned by their normal shift starting time and were considered to have dismissed themselves. Entumeni mill could not be contacted yesterday.

The general secretary of the National Union of Sugar Manufacturing and Refining Employees, Mr Selby Nsibande, said at the Industrial Council meetings last week the union had demanded that the food allowance be raised from the present R30 to R107 a month.

Employers responded by offering to raise it by R10, he said.

Although, a formal dispute had not been declared, Mr Nsibande said, the 'wildcat' strikes 'show we are at a stage of deadlock'.

Canteens

The chairman of the employers' association, Mr Glyn Taylor, said that traditionally black workers living in hostel accommodation had eaten at industrial canteens at no charge but more recently there had been pressure for a cash allowance to enable them to feed themselves.

'The dispute is centred on the amount of the feeding allowance,' he added.

No formal dispute had been declared by the union, he said, and even if it had been, the council's procedure required that the matter be referred to mediation or arbitration.

A spokesman for Umfolozi mill said the management had spoken to their 1 200 workers on Monday night and appealed to their 'better senses'.

'We told the strikers that while they were out they were not being fed so they should rather return to work and let the matter settle itself industrially.'

(3) Season

~~11/11~~ (11/11)

News 3/11/82

1
2
3
4
5

Rbm
3/1/82

Hulett's fires 1 000

Labour Correspondent

WELL over 3 000 workers at six Natal sugar mills have been on strike for the past three days — and more than 1 000 at two mills were fired yesterday after ignoring an employer ultimatum to return to work.

But at two other mills, most of the workers returned to work yesterday, according to a spokesman for Hulett's Sugar.

And a dispute is simmering at Anglo American's Mondi Board Mill at Felixton. Workers meet tomorrow to discuss the company's refusal to bargain wages with Fosatu's Paper, Wood and Allied Workers Union (PWAU) outside an industrial council.

The sugar strikes follow a meeting last Friday in which Mr Selby Ntsibande of the National Union of Sugar Refining and Manufacturing Employees Union demanded that workers' food allowance be raised from R30 to R107.

At the weekend, workers at four Hulett's mills and two others, Entumeni and Umfolozi, went on strike.

According to Hulett's, workers at Mount Edgecombe and Felixton were back at work yesterday following the company's return-or-be-fired ultimatum.

But more than 1 000 workers at its Darnell and Matikulu mills were fired for ignoring the deadline.

The committee has recommended a minimum output of 150 000 tons of sugar — enough to justify a mill — of which 118 000 tons would be derived from White farmers in the Onderberg and 32 000 tons from black farmers of KaNgwane.

The KaNgwane territory has asked that its land be put to sugar cane to provide employment. It has a small area under cane.

Farmers near Komatipoort plan a dual-purpose plant to process sugar and ethanol.

TSB told the committee that it planned to expand the mill at Malelane 'within the near future' to handle cane from a further 8 000 ha — a boost of 50 000 tons of cane.

The Government has the final say on granting of more land and the recommendations of the Rofch Report have been with them since the end of September.

Pleas to expand in KwaZulu, the Transkei, Pongola, Makatini Flats and elsewhere have also been made.

The sugar millers at Malelane (Transvaalse Suikerkerporasie Beperk -TSB- owned by Volkskas Bank) think that the SA Sugar Association has made a very conservative estimate of sugar expansion and that there is adequate room for another mill or extensions to the existing plant.

Drawback

Major drawback is that the lands must be irrigated for cane and there is a shortage of stored water. The Mountain View Dam on the Kaap River which would irrigate another 15 000 hectares is to be built if a new mill is authorised.

Another difficulty not dealt with in the Rofch Report is the fate of KaNgwane, which is supposed to be swallowed up by Swaziland but which would be able to supply over 6 000 hectares of cane land and would be a vital cog in the decision to expand.

Farmers in the area are very keen to increase the population density as they regard this border area abutting Mocambique and Swaziland as important for security.

A new mill would provide nearly 10 000 jobs in the fields and at the mill. There are about 60 000 people in the area, excluding KaNgwane.

About 19 300 hectares is already under cane and feeds the mill at Malelane which makes timber

board from the bagasse. More would be planted if additional quotas were granted.

TSB has made three suggestions based on economic studies. These are to double the capacity of the existing mill and put a new mill at Komatipoort or a satellite mill to extract juice which would be carted to the existing mill.

The company favours a plan to expand the 200 000 tons-of-sugar-a-season existing mill and says that if certain bottlenecks are removed the mill could increase capacity by 40 percent.

Some cane producers in the Onderberg, as the area is called, want a mill elsewhere as the existing site is not suitable and a one-mill organisation is not able to cope with breakdowns; others say that mill expansion is favoured before a new mill is built.

The Committee said it was aware of an application for a mill submitted in 1979 to the Government. The name of the 'large industrial company' concerned was not disclosed.

Irrigation

The Lebombo Boerevereniging wants to set up a farmer's co-operative for a 'sugar-cum-ethanol' plant at Komatipoort. Its pre-feasibility study conducted by an international firm of sugar consultants says the project would be 'economically viable and commercially sound'.

The KaNgwane Government says that about two thirds of the territory is in the Lowveld with about 23 000 hectare available for irrigation. Only 219 ha is under cane on the Lomati River, which will be settled by individual farmers this year.

A further 450 ha under cane in the Louw's Creek area is to be handed over by the South African Government to KaNgwane.

There are some 16 000 families in the area with just over 6 000 families in subsistence farming. About 15 000 people work outside KaNgwane.

The Government thinks that sugar cane would be the best crop for the area to provide employment and income. Last May the Government asked South Africa to boost its cane quota to 7 000 ha from the existing 219 ha.

It said that the Malelane mill had reserved capacity for cane from a further 2 000 ha of land in KaNgwane all within 75 km of the mill.

The proposal for the additional land would be to

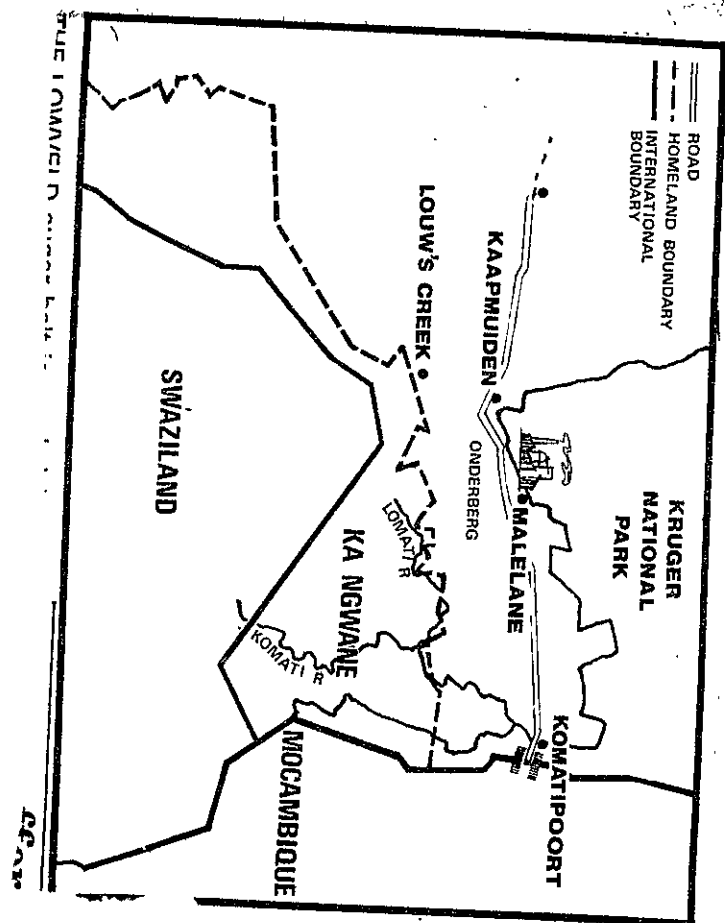

Plea for expanded sugar industry in E Transvaal

Financial Editor
 FARMERS and the sugar millers in the Eastern Transvaal have made a strong plea to the Rofch Committee of Inquiry into the sugar industry for major expansion in the area. They want enough canelands to justify a new sugar mill which could cost R100 million.

(3) sugar
measuring 411172



develop 633 ha every year which would yield some 3 100 tons of sugar for the next 10 years — by 1990 6 330 ha would be planted yielding some 31 655 tons of sugar.

cees a r b y

Mercury 5/11/82
Pongola
sugar
farmers

poorer

Financial Editor

SUGAR farmers at Pongola on the Transvaal-Natal border are getting poorer because their farms are small, they cannot get enough irrigation water and then the impact of inflation.

In the past four years there has been a 'gradual decline in the financial position' of the farmers.

This was the gist of the Pongola Cane Growers' Association's evidence to the Rorich Committee of Inquiry into the Sugar Industry.

The farmers, while agreeing that the industry should not expand, make a special plea for their area. They want an additional 2 623 hectares — equal to 24 000 tons of sugar — and a dam built on the Pongola River.

Problems

They say they are facing pressing financial problems. There are also sociological problems.

The cane output is about half the industry average. The farms are small and cannot be farmed economically.

Pongola has an unfavourable geographical location, there is a lack of adequate schools and medical facilities. All of which add to the farmers financial burdens, they stress.

Another question the farmers raise is the strategic role of the community.

'It is in a border area and forms a corridor from the interior to the coast.'

Workers on sugar farm 'fired after downing tools'

Labour Reporter
ABOUT 100 workers at a Mtubatuba sugar farm were fired yesterday after they had downed tools in support of their demand for the re-instatement of a dismissed colleague, union sources said.

Mr Mathew Oliphant, the general secretary of the National Federation of Workers' affiliate, National Iron, Steel, Metal and Allied Workers' Union, said workers at Mr

Peter Hitchins' farm had stopped work when one of their colleagues had been dismissed.

He linked the dismissal to a letter sent by the union to all the farms in the area calling for a minimum wage of R180.

Mr Hitchins had told his workers he was not going to comply to the union's call, Mr Oliphant said.

Tension had been building up since then and when the worker had

been fired, others had stopped work, he said.

They claimed their colleague had been unfairly dismissed, he added.

He said the striking workers had been told to collect their wages at mid-day yesterday.

Mr Oliphant said when he had contacted Mr Hitchins he had been told that there had been legitimate reasons for dismissing the worker but was not prepared to discuss them.

Farmer evicts his striking workers

3/22/32
Labour Reporter

STRIKING labourers and their families at a Mtubatuba sugar farm have been evicted from the farm's compound and taken to the bus ranks in town, union sources said.

The National Iron Steel Metal and Allied Workers' Union's general secretary, Mr Mathews Oliphant, said the farmer, Mr Peter Hitchins, had told his labourers that he would be closing his farm until May because of the strike.

According to Mr Oliphant, Mr Hitchins also said he would not be re-employing the striking workers when the farm reopened — as had been reported before.

The labourers downed tools on Monday following the dismissal of a colleague. They were subsequently fired but talks between the farmer and the strikers continued.

The strike is believed to be the first labour action in decades by farm workers who, because they are excluded from the country's labour legislation, technically have no right to strike or belong to a trade union.

3-Sugar
~~152~~
~~137~~
~~137~~

SUGAR
 Mrs 6/12/82
 3 sugars

Spreading Sweetness

The Government's Sugar Committee got little thanks in return for all its labour. Yet its main recommendation looks sound enough. But how do you mark a paper if bad reasoning yields the correct answer? Has the student cribbed?

Dr A J V Rorich's committee has in one broad sweep advocated the expansion of the country's cane-planted area by 96 000 ha to produce 489 000 tons of extra sugar during the next 10 years.

This amounts to an increase of the area planted to cane by 25 percent in the face of a fast-deteriorating export position and resistance by diet-conscious consumers in the home market.

KwaZulu, kaNgwane, Transkei and Mangoshe are to get production allocations of 175 000 tons and the white farmers of the Onderberg (Eastern Lowveld) 118 000 tons, which will justify a new mill in the Komat-

ipoort area. This has jolted the sugar industry. Sugar has been Natal itself for ages, and Natal has meant sugar. The growth and development of both have gone hand in hand for a century.

As the economy of Natal matured, so did the sugar industry, guided by the Sugar Act of 1936 — dusted off in 1978 — along lines similar to the controlled marketing of maize or wheat.

But it is being administered by the Department of Industries. In addition, sugar production was from the outset subject to quotas restricting entry, and a unique system of sharing of revenue between millers and farmers.

It has worked well — in a static, complacent way.

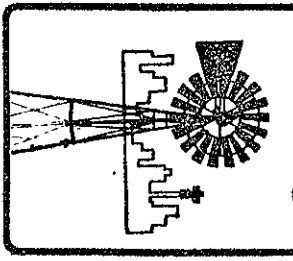

Hannes Ferguson Farming

gar potential is waiting to be tapped. Hard-pressed pioneer farmers, far removed from the contented sugar belt of Natal, want to develop their resources — and only by planting sugar can they make the grade.

The first fields under the new Malelane mill showed it could be done — yields were twice those of Natal. Here the new technology of irrigated sugar growing had proved its worth.

So the Onderberg needed quotas. But the established industry, mindful of its markets, stalled. Likewise, the impoverished kwaZulu homeland, on Natal's doorstep, clamoured for quotas. So did Transkei and kaNgwane. They pointed to Swaziland, where a large sugar industry

had mushroomed into existence regardless of export trends, and had succeeded.

The Government then sent in the Rorich Committee. It had to reconcile the claims of the homelands and the Onderberg border region with the Sugar Association's doubts about the market situation 10 years from now — and it felt that expansion would be risky.

As the committee accepted the 1.1 million tons export figure for 1991 as a maximum, it then had to justify the required expansion by embarking on a lengthy exercise in futurology, which involved changing the growth assumptions used by the Sugar Association and finding that its estimate of 1991 production was a bit too high.

In the same way it found that the association's projection of home market sales was a bit too low.

Thus the committee made room for an expansion of 141 000 tons of sugar.

To this the committee added 179 000 tons by not accommodating "vertical expansion" by improved yields and methods in case of all growers producing more than 7 000 tons of cane annually.

But additional quotas totalling 27 000 tons of sugar would be allocated to small growers to bring their production up to 7 000 tons of cane annually, which was regarded as the minimum crop for an economically sized sugar farm.

Hereby the committee introduced a new objective: protecting small growers and

countering the trend to ever-increasing cane growing units. Where do the sugar growers stand if the Government accepts the report?

Natal growers feel that they should first review their cane transport cost arrangements, which were severely criticised by the committee.

This might take six months. During the same period a technical committee would consider possible sites for a new mill in the Onderberg.

Meanwhile South Africa's sugar export position will be reviewed by the International Sugar Organisation in May.

The pressure on the export market has increased since the Sugar Association submitted its estimates to the committee.

to possible exclusion from the
 to an invigilator before leaving the
 books must be handed to the com-
 n answer book is to be torn out.
 or with any person except the invi-
 are not to communicate with other
 idates are so instructed.
 brought into the examination room
 otes, pieces of paper or other mate-

External	(3)	60	59	64	62	57											
Internal	(2)																

RY CANDIDATE MUST enter in
 m (1) the number of each question
 wered (in the order in which it has
 n answered); leave columns (2) and
 blank.

BUSINESS

R236m debt a bitter pill for the embattled sugar industry

R236m
3 sugars

Business Editor
THE South African sugar industry faces a financial crisis with a deficit for the current season of about R146-million.
In addition, the price stabilisation fund, which was drained during the recent drought in the sugar growing areas, still owes R136-million which

was borrowed to help farmers crippled by the drought.
Fortunately there is a surplus of R46-million from last year's export crop which will reduce the overall deficit to about R100-million.
This brings the total debt facing the industry to about R236-million.
There is no doubt that the industry is

going to have to borrow, said South African Sugar Association (Sasa) general manager Peter Sale, but just how much and where is still to be decided.
One of the key factors is a domestic increase in the price of sugar. Sale would like to see a price hike equivalent to that of the CPI of about 15% to help offset rising costs.

But that depends on the Government's attitude.
Still smarting from the refusal of the last increase in the sugar price Sale refused to guess what, if anything, Government will allow in the way of price increases.
"We just present them with the fig-

ures and wait for their conclusions."
Sale is hoping for an increase, but has no idea when, or if, it will come.
And with Government's current anti-inflationary actions, it would seem unlikely that, if an increase were granted, it would be substantial enough to make a major dent in the mammoth deficit facing the industry.

This means that Sasa is again going to be forced to borrow to make ends meet. He said overseas and local sources would be investigated for the best terms.

Despite lower interest rates overseas, he said, items such as forward cover and exchange rates made the overall cost of a loan much the same, no matter where or in what currency it was negotiated.

"The main thing," Sale said, "is that as well as the best rates available, we also want to borrow for a minimum of five years, which could possibly rule out the use of local money for the entire amount outstanding."
The two main causes of the problems facing the sugar industry are:

- The disastrous drought in 1979/80 which drastically cut production and income, just as the world sugar price started to rise.
- The heavy surplus. The world surplus to August this year was estimated to be about 8-million tons. India-

Admen are blowing their own trumpets

AD AGENCIES are practising what they preach. The past few months have seen a number of agencies climbing into corporate advertising — selling not only the wares of their clients but their own.

Bad ad of the week

live dangerously than to die quietly.
Included in the package was a brand identikit and a launch identikit which allowed interested ad agency buyers a chance to become acquainted with the recently

ARE YOU READY FOR A COMPLETE GAS?

Puzzling invitation for a taste of hot air

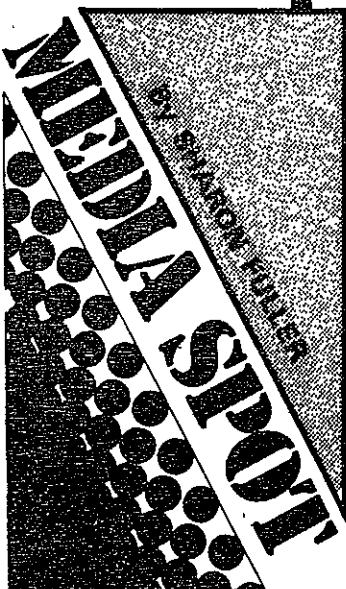

Place an X next to your choice and leave this lying around!

Books for Men's Issues

Books for Men's Kids

a bitter pill for sugar industry

have to borrow, said South
sugar Association (Sasa) gener-
Peter Sale, but just how
where is still to be decided.

the key factors is a domestic
in the price of sugar. Sale
to see a price hike equiv-
of the CPI of about 15% to
rising costs.

But that depends on the Govern-
ment's attitude.

Still smarting from the refusal of the
last increase in the sugar price Sale
refused to guess what, if anything,
Government will allow in the way of
price increases.

"We just present them with the fig-

ures and wait for their conclusions."

Sale is hoping for an increase, but has
no idea when, or if, it will come.

And with Government's current anti-
inflationary actions, it would seem un-
likely that, if an increase were granted,
it would be substantial enough to make
a major dent in the mammoth deficit
facing the industry.

This means that Sasa is
again going to be forced to
borrow to make ends meet.

He said overseas and local
sources would be investigat-
ed for the best terms.

Despite lower interest
rates overseas, he said,
items such as forward cover
and exchange rates made
the overall cost of a loan
much the same, no matter
where or in what currency it
was negotiated.

"The main thing," Sale
said, "is that as well as the
best rates available, we also
want to borrow for a mini-
mum of five years, which
could possibly rule out the
use of local money for the
entire amount outstanding."

The two main causes of
the problems facing the su-
gar industry are:

- The disastrous drought in
1979/80 which drastically
cut production and income,
just as the world sugar price
started to rise.

- The heavy surplus. The
world surplus to August this
year was estimated to be
about 8-million tons. Indica-
tions for the year to August
next year indicate a further
surplus of 4-million tons.

Sale said this was one of
the most prolonged periods
of crisis faced by the indus-
try, but he did see some light
at the end of the tunnel.

First, the price on the Lon-
don sugar market has risen
from a low of £81 a ton to
£107 on Thursday.

Second, the futures price
is also showing positive
signs. For December 1983 it
is in the region of £140 a ton,
for March 1984, £146 and for
May it jumps to £152 a ton.

In addition, South Africa is
one of the cheapest produc-
ers in the world and this will
help the recovery process.

Sale said most farmers
would survive as long as
their sales were supplement-
ed by loans.

But there was no doubt
that some of the smaller and
more inefficient growers,
mortgaged to the hilt, would
be forced to sell before the
situation began to improve.

Sale said that as soon as
trends became clearer, Sasa
would begin to create future
financial planning.

air jets

dangerously than to die
fly.

cluded in the package
a brand identikit and a
identikit which al-
interested ad agency
as a chance to become
ainted with the recently
edited agency and their
beds of doing business.

□ □ □

EDITED South Afri-
advertising agencies
for the first time, play a
role in the accredita-
process.

ne Joint Accreditation
ommittee (JAC), which will
its members from the
and broadcast media
as from the advertis-
industry, now has the ac-
tation portfolio.

applications for ac-
tation will, from Janu-
1, be subject to scrutiny
the JAC, which will be
sured to grant, with-
or, when necessary, re-
agency accreditation.
nese powers were for-
ly vested in the National
Union for printed me-
and the SABC.

□ □ □

ER Hands pitched for
won - chip manufac-
Willard's packaged
account for Fresh Up
Stimorol. The account



Puzzling invitation for a taste of hot air



● The intriguing cover of the invitation. . .

MEDIA representatives and others were invited to "meet
a wide variety of successful clients, disturbed creative
people, ethereal photographers, confident media peo-
ple and a troupe of nervous account executives".

The invitation, which came in the form of a jigsaw
puzzle piece, also offered "no sweat — plenty of fun".

The sweat was puzzling out where the invitation came
from. A phone call revealed that it was Complete Adver-
tising which, said MD David Roberts, accounted for the
invitation to have a complete gas.

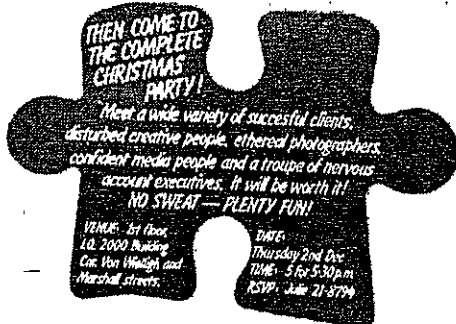

. . . and the puzzling words of welcome.

moves from DeVco, which
also made a bid for the
account.

Also in doing battle were
McCann, CDP, Partnership
and Grey Sandton.

Bid to settle sugar dispute

(3) Sugar #11111 Mercury 1/2/282

Labour Reporter
TALKS continued yesterday in a bid to settle the dispute at a Mubabuba sugar farm which led to about 100 labourers downing tools on Monday.

And it is understood that the labour unrest spread to other farms in the area yesterday when workers staged sympathy strikes.

In what is believed to be the first labour action by farm workers for decades, the labourers at Mr Peter Hitchins' farm struck in support of a demand for the reinstatement of a dismissed worker.

Mr Mathews Oliphant, the general secretary of the National Iron Steel Metal and Allied Workers' Union, who claims to represent the labourers, said Mr Hitchins

told him that he had tried his best to solve the matter, but he was not prepared to take back the dismissed worker.

Mr Hitchins said he had decided to close down his farm from last night and the labourers would be told to vacate the compounds and go back to their homes with the promise of re-employment if the farm reopened, he said.

Mr Oliphant said other members of the union had been watching the situation at the Hitchins' farm and had decided to strike in sympathy.

Later, Mr Hitchins told the Mercury that he had spoken to his labourers yesterday but they were still not working. He said he would be waiting to see what today brought.

Sugar industry propping up the sagging Natal economy

19/12/82
3 Sugar
S. Wilmer

Finance Reporter

THE sugar industry is once again proving to be a vital prop to the sagging Natal economy.

Although world sugar prices are still deep in the doldrums, more than R100 million a year is being injected into service industries in Natal.

Peter Sale, general manager of the South African Sugar Association, says large slices of this cake go to road transport operations and the engineering sector.

Other large payments go to Escom, the railways, fuel, paint, vehicle and fertiliser suppliers. A record 22 million tons of cane is expected to be milled this year.

Ernie Patterson, general manager of Natal United Transport, says the company hauls more than 60 000 tons of cane and by-products a month under contract to Lonrho's Glendale sugar estate near Stanger.



Patterson

"The good rains have produced a heavy crop and we are very busy on this front," he says.

The sugar operation is helping to counteract a shrinkage of about 20 percent in the company's general haulage business.

Patterson says some of the smaller hauliers have seen loads shrink by up to 50 percent but the larger companies are cushioned from the recession by long term contracts with the sugar producers and other industries.

Natal United Transport has started a development programme in anticipation of an upswing on the business cycle in 1984.

Neil Evans, Natal director of Plascon-Evans Paints, says sales of structural steel coatings to the sugar milling industry have been a bright spot in recent months. The industry is a major consumer of paints, particularly in the off-crop period when maintenance takes place.

SUGAR

1983

JANUARY — NOVEMBER

SUGAR (3) SUGAR

Sticky patch

PM 28/1/83

Prospects for SA's sugar industry remain depressed. World prices show no signs of coming off the bottom and even with the pending increase in the local sugar price, the SA Sugar Association (Sasa) expects a R150m deficit this season. Under the circumstances, it will have little choice but to increase borrowings by about R40m.

Sasa GM Peter Sale has already been overseas to talk to bankers. Sasa's heavy commitment to existing foreign loans and the favourable Eurodollar rate indicates that further loans will come from abroad rather than locally. According to Sale, crop estimate for the 1982-1983 season is a record-breaking 2,14 Mt despite poor winter rains. The previous record was 2,05 Mt in 1977-1978.

He says last season's surplus of R46m will be used to reduce the total deficit to around R100m, which will be financed through a combination of increased borrowings, an increase in the domestic sugar price and a reduction in the return on capital to growers and millers.

Smaller growers and those who have purchased farms recently on high interest loans will be particularly hard hit.

But there could be worse to come. Few observers expect world sugar prices to recover substantially in the short term, which suggests another deficit in the 1983-1984 season. And if farmers have to accept returns below the permitted yet again, some could go out of business.

Sale, however, discounts speculation that

the current crisis could lead to widespread insolvencies among farmers.

At the root of the problem is the massive surplus on the world sugar market, brought about by declining consumption, increasing use of alternative sweeteners and extremely favourable climatic conditions in most of the producer countries. Last year's world surplus of 8 Mt is expected to grow by a further 4 Mt this season.

Most sugar men, including Sale, feel that nothing short of a major catastrophe can restore the balance between supply and demand and send export prices back to more acceptable levels. Those who are not counting on a natural disaster to correct the situation, are pinning their hopes on a new International Sugar Agreement (ISA).

Although the current agreement, which expires at the end of 1984, has failed to maintain world prices at reasonably high levels, Sale believes that a new agreement could work — provided the EEC countries are signatories. The EEC, which is currently outside the ISA, is said to be a major contributor to the world sugar surplus.

But common market negotiators are believed to have participated in preliminary discussions and there is a good chance that they will sit down with other producers in Geneva in May to thrash out a new deal. The upshot could be a new and more workable agreement which would take effect in 1984 or early 1985.

3 Sugar

Four blacks in delegation

3/1/23

**African Affairs
Reporter**

FOUR blacks from Natal have been included in a South African delegation to attend the 18th Congress of the International Society of Sugar Technology to be held in Cuba next month.

Mr M Morgan, editor of the Sugar Journal, told the Mercury yesterday that the black delegates to attend the congress in Patricho included Chief L D Dlamini, KwaZulu's Minister for Agriculture and Forestry, Mr A M S Mhlongo, a sugar farmer in Ndwedwe, N. E. Strydom, a coloured from Mangete and a member of the of the Sugar Advisory Board, and Mr Pat Boader, an Indian sugar farmer in New Gelderland.

Tour

More than 1 500 delegates from various sugar producing countries will attend the congress and 200 papers will be delivered of which five will be read by South African

delegates.

The delegation leaves on February 15 and the congress will go on until February 26. Delegates will also tour sugar producing countries before returning home in March.

Mr Mhlongo the former president of the Natal and Zululand Sugar Farmers' Association, said he was delighted to be included in the delegation and hoped that he would be given an opportunity to address the congress.

Mr Mhlongo said he would tell the congress that South Africa was on the way to change and whites had realised they could not run the country without blacks.

'Blacks were now being honoured for they have been included in the delegation and this is of vital importance for the image of the country.'

Sugar men seek price increase

Natal
Mercury Reporter 16/2/83

THE sugar industry is seeking the Government's approval for an increase in the local price and loans to cover a loss of about R50 million in the 1981-82 season.

If the industry does not receive assistance, the loss for the current season could be more than R150 million.

The last price hike in the domestic market was in March, 1982, when refined sugar was increased by R50 a ton and brown sugar by R42.

In April there was a further increase in consumer prices to off-set higher rail and motor transport tariffs. These did not affect Durban.

The industry, which already has a debt of about R130 million, has been driven into a corner by drought and the low export price.

Last season the industry sold 1 152 027 tons on the local market and shipped 802 417 tons to Japan, Canada, South Korea and the U.S.

Much of these exports were priced forward when world prices were standing at a level of £300 to £400 a ton.

Today, the world price is down to £110 a ton — well below the cost of production.

World price

Natal companies, which are having to face large losses in their sugar divisions, are making drastic economies. In addition, due to the drought and the poor quality of the cane, their mills are expected to crush for a much shorter period this year.

Much of the blame for the low world price can be laid at the door of the Common Market countries which have previously set their faces against joining an international sugar agreement. Their producers receive official price support.

However, meetings are now taking place in London with a view to a new agreement coming into operation at the beginning of 1984. The International Sugar Agreement's Committee will have its next session in March.

Meanwhile, all sugar-producing countries are in difficulties and the more sugar they export the more desperate is their position.

If the Government does not come to the assistance of the local industry, and there appears to be no alternative, a wide range of consumer goods will be affected by a price increase.

Among these are mineral waters, sweets, canned foods, ice cream and jam.

Govt grants 7½% hike in sugar price

(3) Sugar (RCA) EOM

25/2/83

CAPE TOWN. — The Government has approved an immediate 7½% increase in the consumer price of sugar, but turned down a request from the industry for an increase of between 14% and 15%.

Announcing this in a Press statement in Cape Town yesterday, the Minister of Industries, Commerce and Tourism, Dr Dawie de Villiers, said the consumer could not be expected to assist in solving the problems of the sugar industry by means of large-scale price increases, Sapa reports.

He said the industry had requested that the annual adjustment of the sugar price for 1983/84 be considered with due allowance for cost increases, the exceptionally poor export price of sugar, and the generally distressful position in which the industry found itself.

"The request, if granted, would have meant that the price of sugar at the retail level would have risen by between 14 and 15%."

Dr De Villiers said it was not possible to accede to the sugar industry's request in view of the Government's determination to reduce the rate of inflation to a more acceptable level.

He said the sugar industry already had loan commitments of R130-million and that further substantial loans would have to be negotiated to finance the large deficits.

The Government had decided that no further production quotas would be considered until such time that the position of the industry improved, Dr De Villiers said.

The Mail's Durban Correspondent reports that the sugar industry considers that the 7½% increase is not enough.

"We are dismayed," said Mr Dick Ridgway, chairman of the Sugar Association, noting that the new price would be below the cost of production.

"This decision is unacceptable and we will be talking to the Government," he said.

There will be a shortfall of R108-million on the current crop season, which ends in April, and the industry will be forced to raise R60-million in loans to keep farmers, millers and refiners solvent.

Two seasons ago the industry obtained R130-million in loans and these have not been liquidated. It will start the new season owing about R190-million.

Mr Ridgway said that in the last decade the domestic sugar price had not subsidised shortfalls on the export market.

"Indeed, some high prices on the export market meant that we were able to divert R190-million to subsidise the local consumer."

Mr Ridgway pointed out that in this period the Government had forced two price decreases on the industry which resulted in a price well below the cost of production — this was followed by "a series of disproportionately high increases which had adversely affected sales".

The consequences of this policy were that "profits" on the export market could not be used to build up reserve funds to meet the sort of situation facing the industry.

fully suspended some

Sugar
 Mercury Reporter
 4/2/83
Major' step
 THE Sweet Food and Allied Workers' Union has concluded negotiations with a sugar company which they regard as 'a major breakthrough'.
 Union official Mr Jay Naidoo told the Mercury yesterday the most important feature of the new agreement was that it had created a new structure for negotiating wages and working conditions on a corporate basis

Fosatu union breaks into sugar industry

By STEVEN FRIEDMAN
Labour Correspondent

SUGAR corporation CG Smith and Fosatu's-Sweet, Food and Allied Workers' Union have signed a ground-breaking agreement.

The accord will allow the union to bargain on wages and conditions at any CG Smith mill where it has a worker majority, will set up a new negotiating organisation within the corporation, and has been reached despite an official industrial council agreement covering some CG Smith mills.

A unique feature is that CG Smith hope the new negotiating group will become a sub-committee of the industrial council, even though SFAWU has not joined the council — this is possible through a little-known clause in Section 25 of the Labour Relations Act allowing a council to delegate any of its functions, such as bargaining in an area, to a committee which includes non-council members.

It will mean that agreements between the union and CG Smith can be published in the Government Gazette and it would be a crime to infringe them.

Announcing the agreement yesterday, a SFAWU organiser, Mr Jay Naidoo, said SFAWU already had a recognition agreement allowing it to negotiate pay at CG Smith's

Noodsberg mill, not covered by the council. It had now gained a majority at Umzimkulu mill at Port Shepstone

The two sides had now signed an agreement creating a negotiating organisation for CG Smith mills. The worker representatives would be six union shop stewards for every mill at which SFAWU gained a majority.

At present, stewards at the two mills where it has gained a majority will be represented and about 1 000 workers will be covered by agreements signed. Mr Naidoo said the union regarded this as a "major breakthrough".

It not only gave it bargaining rights throughout CG Smith, but meant SFAWU had obtained a firm footing in the sugar industry.

SFAWU has been locked in a battle with the National Union of Sugar Manufacturing and Refining Employees (NUSMRE), which sits on the council. Mr Naidoo said the entire workforce at Umzimkulu had resigned from this union to join SFAWU.

CG Smith's personnel director, Mr Barry Horlock, described the agreement as "ground-breaking". He believed it was the first recognition agreement giving a Fosatu union bargaining rights across an entire corporation. SFAWU had agreed that other unions could take part in the new organisation. Mr Horlock said management also hoped to see the new body become the basis for a council sub-committee.

③ SUGAR FM 4/3/83

SWEETENER

The South African Sugar Association has concluded an agreement with a local bank for a loan facility amounting to R60m. This will bring the association's total borrowings to R190m.

The latest loan is for five years. The agreement contains a multicurrency option clause, which means the association can choose in which currency it actually draws down the funds.

The choice of currency will be largely determined by the rates of interest at the time the funds are drawn.

The borrowing is slightly unusual in that it carries a government guarantee. Most private sector loans do not carry such guarantees.

The money is designed to help the industry over the present difficult conditions it is experiencing. The industry recently expressed dismay that the sugar price rise to the consumer was being limited to only 7,5% by the government.

Massive crop failures hit Natal farms

Mercury Reporters

FARMERS in several regions of Natal are fighting for survival against massive crop failures through the drought, and many have written off completely the chance of harvests this season.

A Paulpietersburg maize grower, Mr J Solms, said yesterday he expected to lose R600 000 this year, while an estimated R80 million loss was collectively predicted for other maize producers in the area.

Mr Solms, who had expected to reap about 8 000 tons, now expects only 1 200.

Farmers in the district had told him they had never experienced such a dry period — not even during the notorious drought of 1933.

'The fight for survival is on,' Mr Solms said.

But farmers are not alone in their plight — even hotel guests have been affected.

Driest

February

PIETERMARITZBURG experienced its driest February since 1903, the Darvil weather station reported yesterday.

Newcastle innkeeper Barry Noble has asked guests to bear the desperate situation in mind when they bath and shower.

The Newcastle High School headmaster, Mr J H Beukes, said gardens in the town looked worse than they did during

Fight for survival

Handwritten notes:
① ~~Maize~~
② ~~Wheat~~
③ sugar

winter.

'Although people are using bath water to flush their toilets, we do seem better off than some.

'A Dundee visitor here yesterday asked for drinking water to take home with him.'

Dundee's Deputy Town Clerk, Mr L E Pienaar,

said households were now restricted to two kilolitres a week and that water supplies to homes would be cut off if this limit were exceeded.

'There's only enough water in local dams to last two weeks. If we don't get rain we'll have to set up tanks at various points for

people to collect drinking water.'

Only two 25 l containers a person would be allowed at a time if such drastic steps were taken.

Water restrictions in Dundee include a total ban on watering gardens, even from left-over bath water, topping up swimming pools and washing cars.

Sugar farmers on Natal's North Coast also face enormous crop losses.

Mr Dave Addison estimated only a 60 percent yield.

'We've had four bad years in succession. The growing period just past — from September to February — has been the worst in 50 years.'

'But if good rains fall before April there is still hope that we'll be able to recoup some losses,' Mr Addison said.

In the Midlands, the maize crop has been the severest casualty of the drought.

Lease land

Towns surrounding Durban and on the South Coast have so far escaped water restrictions.

Several said they had had to lease land to provide grazing, and also to reduce their livestock herds, which would otherwise not survive through the winter.

The Town Clerks of Greytown, Mooi River, and Estcourt all reported that they had not yet considered restrictions, and Mr T Millward, secretary of the Lower South Coast Water Corporation, which controls the water supply between Hibberdene and the Transkei border, said the Umzimkulu River was more than adequate for their needs — at the mo...

Imports may be needed to bolster local maize crop

Mercury Correspondent

PRETORIA—The Maize Board may be compelled to import maize this year to supplement the local drought-ravaged crop.

There is an 'outside' possibility too that wheat may also have to be shipped into South Africa.

So not only will South

Africa lose millions of rands in foreign exchange because there are no export surpluses, but the loss will be increased if the country has to import maize and wheat.

The chairman of the Maize Board, Mr Crawford von Abo, claims the drought will rob South Africa of R600 million in foreign exchange earnings from maize exports during the 1983/84 season.

This was the extent of export earnings during the current season.

The board, he said yesterday, had stopped exporting maize several months ago when it became clear this season's crop would be far below average.

The South African Transport Services would also lose out. Revenue from moving maize to the coast for export in a normal year totals about R123 million.

Pretoria sources said yesterday the Maize Board had a carry-over of about 1 000 000 tons into the new season which starts in...

DA
SF
CH
WA
CP
MU
AI
HA

During the period 1982-83 the water was produced...

at

king
 nes
 al-
 such
 en
 us in
 total
 diens,
 bath
 swim-
 -hing
 Na-
 face
 esti-
 -cent
 bad
 The
 past
 Feb-
 the
 fall
 still
 ble to
 Mr
 the
 the
 the

ding
 South
 aped

y had
 a pro-
 so to
 stock
 other-
 ough

ks of
 iver,
 ported
 of con-
 s, and
 etary
 Coast
 which
 supply
 and

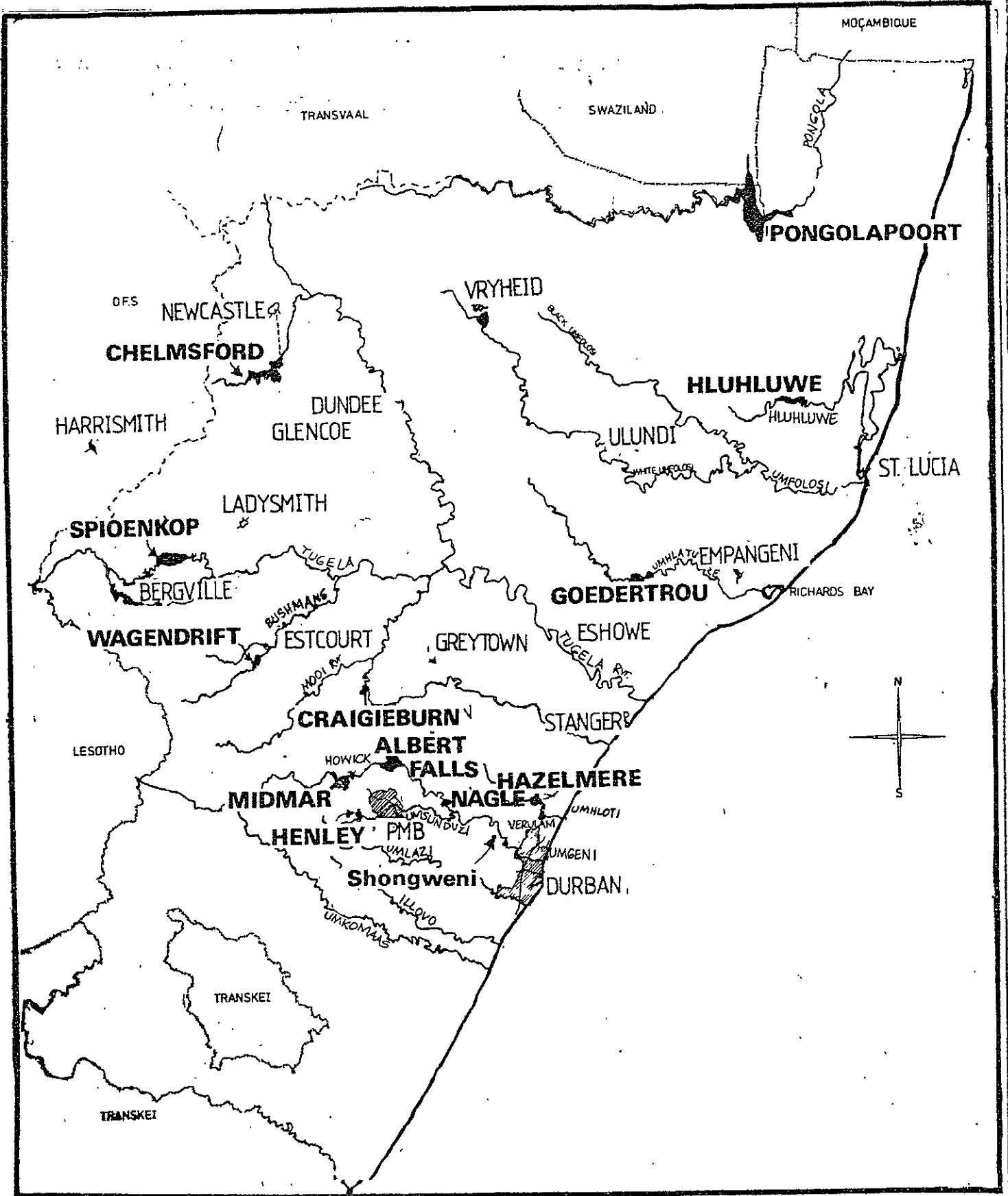

NATAL'S major dams ... and how much water there is in them.

DAM	RIVER	CAPACITY m³ X 10	% 1982	% 1983	PURPOSE
SPIOENKOP	Tugela	282	100	78,67	Ladysmith water supply
CHELMSFORD	Ngagane	198	23	15,0	Newcastle and industrial water supply
WAGENDRIFT	Bushmans	60	97	96,4	Irrigation and Estcourt water supply
CRAIGIEBURN	Mnyamvulu	25	97	80,0	Irrigation of Muden and Msinga
MIDMAR	Umgeni	178	85	37,5	Water supply to Howick, Pietermaritzburg, Cato Ridge, Camperdown, Hammarsdale, Pinetown and irrigators
		287	11	0,12	Balancing reservoir for Nagle Dam

The South African Transport Services would also lose out. Revenue from moving maize to the coast for export in a normal year totals about R123 million.

Pretoria sources said yesterday the Maize Board had a carry-over of about 1 000 000 tons into the new season which starts in May.

Although the first official estimate of the crop is announced only later this month, it is considered unlikely that the crop will reach 7 000 000 tons, the extent of domestic demand.

and Estcourt all reported that they had not yet considered restrictions, and Mr T Millward, secretary of the Lower South Coast Water Corporation, which controls the water supply between Hibberdene and the Transkei border, said the Umzimkulu River was more than adequate for their needs — at the moment.

But the secretary of the Ixopo Health Committee, Mrs F H Turner, said if no rains fell this month restrictions would have to be considered.

The Raelton Dam, from which the village usually drew water supplies, was only 38 percent full.

Flowing

Mr Pedy Bam, chairman of the Ixopo Water Catchment Association, described the position of farmers in the area as serious.

The Ixopo River was flowing reasonably at its source, but was 'barely flowing' where it met the Umkomaas River.

There was a particularly dry area around Richmond.

Some farmers there had had to dig pools in the riverbed to find water, which then had to be boiled for household use.

Farmers at Estcourt and Mooi River are also in difficulty.

Mr K Adams, who farms maize in the Ntabamhlope area, near Estcourt, said his entire crop had been written off.

All he could do was cut it for silage.

The livestock situation was not so bad because water could still be pumped from the Wagendrift Dam.

WAGENDRIFT CRAIGIEBURN MIDMAR	Bushmans Mnyamvulu Umgeni	60 25 178	97 97 85	96,4 80,0 37,5	water supply Irrigation and Estcourt water supply Irrigation of Muden and Msinga Water supply to Howick, Pietermaritzburg, Cato Ridge, Camperdown, Hammarsdale, Pinetown and irrigators
ALBERT FALLS HAZELMERE	Umgeni Mdloti	287 24	14 99	9,18 86,7	Balancing reservoir for Nagle Dam Water supply for North Coast regional water supply corporation and irrigators Irrigation, Water supply for Mhlatuze Water Board
GOEDERTROU	Mhlatuze	321	0	11,7	
HLUHLUWE PONGOLAPOORT HENLEY	Hluhluwe Pongola Umsunduzi	29 2501 5,8	87 —	22,9 1,89 64	Hluhluwe water supply, irrigation Irrigation Water supply Pietermaritzburg not in- cluded in Umgeni system for rationing

NAGLE: Not a storage dam but is used for abstracting water from Umgeni River and grading water supply to Durban.

AGRICULTURE ⁽³⁾ SUGAR

Sugar shakeup

FM 11.3.83

The South African Sugar Association (Sasa) is not happy with the 7,5% increase in the domestic sugar price granted by government last month.

Producers say government twice forced them to drop the domestic price when sugar export earnings were high; now it will not allow adjustments in the local price to compensate for the low world prices. Lurie Gordon-Hughes, chairman of the SA Cane Growers Association says it has "changed the rules to suit itself."

Sasa GM, Peter Sale, claims the Durban price of R462/t does not even cover the cost of production. "Given the drought and low world prices," he says, "negotiations for next season's prices are likely to be conducted earnestly."

The increase granted is roughly half the amount requested by Sasa but Minister of Industries, Commerce and Tourism Dawie de Villiers says this is in line with government's anti-inflation drive.

The price ruling means the industry will

have to borrow an additional R60m to help finance its deficit and will increase Sasa's total borrowings to R190m.

As the increase has come late, its impact will be felt more during the 1983-1984 season, which, at this stage, does not look promising. World prices are expected to remain low and the drought is likely to markedly reduce the size of the crop.

at Inanda being
transport.

Watters relentless

23/4/83
If these people were
rentals, what moti-
tion would there be?
Mr Kearney said he had
shown hand-written
receipts given by the land-
lords to the squatters
'We know the State's
policy is to keep down the
numbers of blacks in ur-
ban areas. If Indian land-
lords are being used to
carry out Government
policy, this is promoting
bad relations between In-
dians and Africans.
Spokesmen for the
squatters said they pro-
posed to travel to
Durban on Monday to
lead their case with the
deputy commissioner of the
Department of Co-Oper-
ation and Development

Fine for threat

Mercury Correspondent
JOHANNESBURG—An
Alberton private detec-
tive was fined R400 in the
Johannesburg Magis-
trate's Court yesterday
after he was found guilty
of threatening the life of
tennis star, Johan Kriek.
Alfred Patrick O'Driscoll,
44, of Petersfield Street,
Raceview, was found
guilty of contravening the
Intimidation Act.

3 held after killing of senator

HARARE—Three men
had been arrested in con-
nection with the killing of
Zimbabwean Senator
Paul Savage, 70, his
daughter Colleen, 20, and
their British visitor, Miss
Sandra Bennett, 38, the
Zimbabwe Government
announced yesterday.

The arrested men were
identified by a Govern-
ment spokesman, Mr Jus-
tin Nyoka, as being
dissidents loyal to the
run-away opposition lead-
er, Mr Joshua Nkomo.

One of the men had ad-
mitted being involved in
the killings and had also
told of the involvement of
seven other dissidents
who had since crossed the
border into Botswana, the
spokesman said. Police
investigations in liaison
with Botswana authorities
were under way.

Court

The spokesman said po-
lice had also established
that a dissident injured
during the shooting at the
Savage homestead about
130 km south of Bulawayo
was taken to a traditional
healer near the Botswana
border and later taken
into Botswana for further
treatment in Francistown
where he was in hospital.

The traditional healer
and his son had been ar-
rested for helping the dis-
sident to leave the
country. Steps were being
taken to ensure the man's
return to Zimbabwe and
to arrest him, the spokes-
man said. All the men ar-
rested so far would
appear in court soon.

The victims were
gunned down at their
home. One dissident, be-
lieved to have been acci-
dentally shot dead, was
taken away in a vehicle
belonging to the senator
and, when the vehicle
broke down, he was
buried in a shallow grave
— (Sapa)

Salvaged skiboat back home

Mercury Reporter

Sugar union 'gets better deal' from direct talks

Labour Reporter

SUGAR industry wages
have been negotiated out-
side the Industrial Coun-
cil for the first time — and
union members feel
they've ended up with a
better deal because of
this.

The agreement was be-
tween the giant C G Smith
sugar company and the
Fosatu-affiliated Sweet,
Food and Allied Workers'
Union

After more than a
month of negotiations
wage increases ranging

from 13 percent on the
lower grades to 7.5
percent on the higher
grades have been agreed
on

Union branch secretary
Petros Ngcobo said the
union was 'not satisfied
with what we got but we
feel we have achieved a
better deal than the
unions that sit on the
industrial council'

Mr Ngcobo said unions
which sat on the council
had settled for a 7.5
percent across-the-board
increase.

He also said the food ra-
tion allowances at the
Noodsburg and
Umzimkhulu mills had
been increased by R5

Mr B Horlock, C G
Smith's group personnel
director, said he was
pleased with the
agreement.

He said however, that
there had been a last
minute 'technical prob-
lem' with the Natal Sugar
Industry 'Employees'
Union, who were meant to
be party to the agreement,
but he felt sure that the
matter could be solved

Sentenced for slapping baby

Court Reporter

A MAN who slapped his
four-month-old daughter
on the buttocks because
he became irritated with
her crying was sentenced
to 12 months' imprison-
ment — suspended for
five years — by Mr N Kruger
in the Durban Magis-
trate's Court yesterday.

William Louis
Bianchina, 22, pleaded

guilty to striking the child
at his flat at Illovo Beach
on February 15

The Court was told he
had been drinking and
was tired and became an-
gry when the child cried

He admitted a convic-
tion for driving under the
influence of liquor.

Mr Kruger said he had
committed a serious of-
fence and he had to im-

pose a sentence which
would deter Bianchina
and like-minded people.

The Court heard that
the child had been re-
moved from the care of
Bianchina and his wife.
Mr Kruger said it seemed
that they were too young
and immature to have a
family.

Mr C Cornell appeared
for the State.

Former astronaut Glenn aims for the



NEW CONCORD—Former astronaut Sen John Glenn gives the thumbs up as he officially announces his ca-
reer with his wife Annie standing at his side.

hundreds
will be fly-
over the
part. he
Mr Alex
that em-
would not
more wat-
would no-
ing a 40
'We hope
the situa-
proved to
takes plac-

R250

whis

JOHAN-
man was
stealing a
and fin
Hillbrow
P Button,

Gavin :
Twist St
guilty to
lifting
tle of
store on
noon.

Free-
into th-
beers.
he dec-
bottle of

He put
trousers
body
bulge. —

Co

BLOEM-
Bloem-
ment C
ed by
foreign
support
ment's
dustrial
decent-

Pay sweetener for sugar men

Labour Correspondent

THE giant CG Smith sugar company has concluded a wage agreement with Fosatu's Sweet, Food and Allied Workers' Union.

A union statement said the agreement gave workers a more substantial rise than that granted by the sugar industry's industrial council.

The company recently negotiated a ground-breaking recognition agreement with

the union giving SFAWU bargaining rights in any CG Smith mill where it wins a worker majority.

A key aspect of the agreement was that the union could bargain on pay with CG Smith outside the industrial council.

The union statement said the pay negotiations - which covered two mills at which it has a majority, Umzimkulu and Noodsberg - began on

March 8 and were "tough".

It said it had won a 13% increase for lower paid workers and 7,5% for the higher paid grades. This compared with an "across the board" increase of 7,5% negotiated at the industrial council.

"We are not satisfied with what we got but we feel we have achieved a better deal than the unions that sit on the council," said union branch secretary Mr P Ncgobo.

UJGF

Sugar cane farmers benefit ³ from rain ^{Sugar}

25 APR 1988

By Hannes Ferguson
Farming Correspondent

Widespread but localised rains have benefited parts of the Eastern Transvaal, Natal and the Eastern Cape.

On Saturday Queenstown received 10 mm, Umtata 9 mm, Durban as much as 56 mm, Ladysmith 12 mm, Estcourt 5 mm and Piet Retief 19 mm. Yesterday more rain fell in the southern Lowveld, where Nelspruit received 19 mm, and in the Western Transvaal, where Koster received 21 mm and Derby 19 mm.

According to the Weather Bureau, this weekend's rain was associated with a wintry cold front moving as far north as the Northern Free State.

A spokesman for the Cane Growers' Association in Durban said the southern parts of the Natal sugar belt would benefit greatly by the rain as well as the cane fields of Pongola.

Some parts of the parched bushveld have had rain. Potgietersrus received 19 mm and the Marnitz oasis 16 mm.

On the Transvaal Highveld, Standerton received 11 mm, but farmers say this was too little and too late.

Tshwelopele in Lebowa received 22 mm. Other rainfall figures released by the Weather Bureau are: Bethal 6 mm, Ellisras 6 mm, Goedspruit 20 mm, Rustenburg 6 mm, Krugersdorp 6 mm, Lydenburg 6 mm, Germiston 10 mm and Port Shepstone 14 mm.

FM 29/4/83
TONGAAT-HULETT
Felixton no flop ³
Sugar

Tongaat-Hulett's new R155m Felixton sugar mill, the biggest in southern Africa, is unlikely to become a white elephant despite the drought, and massive surpluses on world markets. That, at least, is the view of TH project director Robin Renton.

He claims that the project is justifiable on rationalisation grounds alone. "The mill replaces the old Felixton and Empangeni mills which needed extensive modernisation," he says. "They were only 12 km apart and serve the same cane supply area. When we did the sums it made more sense to put up one big mill, which will halve the overheads and some of the operating costs.

"In addition, by-products, such as fibre for the nearby Mondi kraft paper mill are more easily supplied from one big unit."
Start-up of Felixton Two is scheduled for

December to iron out teething problems before the 1984-1985 season.

Initial capacity will be 600 t of cane/hour, or 3,3 Mt/year, producing 370 000 t of sugar. There are long-term plans to lift capacity to 900 t cane/hour, but Renton says these will be embarked upon only when additional cane production requires it.

He expects most of the additional cane to come from KwaZulu because the recent commission of inquiry into the sugar industry recommended limited expansion among the small growers there.

TH subsidiaries handled planning and design on the project and supplied most of the equipment, including the two diffusers which are the biggest of their kind in the world. Tate and Lyle Engineering are the contract supervisors.

Crushing season at some sugar mills may be cut by half

Mercury Reporter

SUGAR farmers on the Natal North Coast are already counting their losses as the effect of the 'worst' drought tightens its grip.

And because of the serious crop shortage, many sugar mills are planning to slash their six-month crushing season by half in some cases.

Mr Ernie Morrison, general manager of the South African Cane Growers' Association, said yesterday that although there had been no official notification of an early shutdown of the mills, he expected this to happen because of the serious crop shortage.

Growers to the north of the Tugela, mainly in Zululand, appeared to be hardest hit, he said, adding the full extent of the losses could not be gauged until the rains came.

'There is still a reasonably good chance of saving much of the crop if it rains soon,' he said.

Many farmers were forced

to sell up because of their losses and others would be forced to do the same if the drought continued, he said.

Indian cane farmers on the North Coast are no worse off and in desperation many have turned to the Land Bank for financial assistance.

Mr A Jagessur, assistant secretary of the Natal Indian Cane Growers' Association, said yesterday many farmers faced crop losses in excess of 50 percent.

'The drought is having a devastating effect on our farmers. It's in fact worse than what we had experienced in 1980,' he said, adding that South Africa could expect a big drop in sugar production this year.

The hard-hit farmers, he said, were looking forward for help from the Land Bank for relief. 'Some farmers are already talking of reducing labourers, with bachelors being targets in the firing line.'

EEC sets tough conditions at sugar talks

By NEIL BEHRMANN
 LONDON. — The London daily sugar price surged to £130 a ton, the highest level in a year, while producing and consuming nations grappled over negotiations towards a new international agreement.

In the first two days of the talks, expected to last until May 20, the European Economic Community (EEC) sets out tough conditions for its participation in a new international sugar agreement.

The EEC, a non-member of the present pact, offered a plan for a new international sugar agreement and made it clear that it would enter only on its own terms.

Mr Michael Jacquot, the chief EEC delegate, said that the 10-nation community, the largest

Western exporter, would stay out of the proposed agreement if it was as "ineffective and unsatisfactory" as the present pact.

He hoped that the main 10 sugar exporters, Australia, the Philippines, Thailand, Dominican Republic, India, Argentina, Cuba, Brazil, South Africa, the EEC and developed importing countries would establish buffer stocks totalling 10 million tons. Middle-rank producers would have export quotas, and limited stockpiling requirements.

But small exporters would be free to sell their surplus sugar.

To counter weaknesses in the current agreement, the EEC proposed greater participation by wealthier importing nations and agreement over special term deals.

Mr Jacquot said that the pact should aim at maintaining prices within a range.

The EEC suggestions were cynically received by countries such as Australia.

The EEC is expected to export 5.8m tons this year and members of the present agreement complain that it is dumping subsidized sugar production on the world market.

Mr John Kerrin, Australian Primary Industry Minister, whose country exports 2.9m metric tons, only second to the EEC, blamed the common market for undermining the present pact.

He preferred stricter export quotas instead of higher stocks. The current international sugar arrangement is based on export quotas to control supplies, but members' efforts have failed partially because non-member nations such as the EEC have sold their surpluses on the mar-

ret.

A spokesman for the South African delegation told a Geneva correspondent that there "was common ground to hold larger stocks".

Sugar prices have been firm because of late plantings in Europe, and hot weather in the Soviet Union. Expectations that poor weather conditions in Europe and drought conditions in South Africa, Australia, the Far East and elsewhere would lower supplies in the coming year, helped boost prices. The market has also been buoyed by Cuban buying following severe rainstorms.

"Cuba is buying up all the available sugar on the free market," said Mr Giles Evans, sugar analyst at Conticommodity Services, he expects the market to remain in a "rising trend."

CANAL TIMES
 5/15/83

~~3/5/83~~ 3/5/83

17 000
 14 462
 13 868
 13 300
 13 135
 12 381
 11 849
 10 868
 10 000
 9 834
 9 479
 9 331
 9 000
 9 000
 8 400
 8 300
 8 000
 8 000
 7 835
 7 412
 7 000
 7 000
 6 770
 6 300
 6 248
 6 227
 5 993
 5 800
 5 600
 5 571
 5 400
 5 400
 5 328
 5 020

Mine
 Under
 Mine
 Gener
 Motor
 S.A.R.
 Englir
 Build
 Afric
 UNION
 Cape
 S.A.
 S.A.
 Build
 Black
 Metal
 Nator
 S.A.R.
 Food
 S.A.R. & H. Rummung and
 Blanke Bouverkersvaldom
 S.A. Engine Drivers, Fl
 Coloured Postal Employe
 Volkskas Amptenare Verer
 Die Spoorbond
 Transport and Allied Wor
 Textile Workers Industr
 Garment Workers Union of
 Johannesburg Municipal B
 African Garment Workers
 National Union of Commer
 Electrical & Allied Trad
 Building, Construction &
 National Union of Distri
 Industrial Salaried Staff

UNIONS WITH MEMBERSHIP BETWEEN 5000 AND 10000

SUGAR (3) SUGAR
Rewriting the rules

FM 6/5/83
Predictably the EEC, as the world's biggest exporter, has made an early attempt to mould the 58-nation Geneva talks on a new International Sugar Agreement (ISA). Like everyone else in Geneva this week, the EEC is keenly aware that without its participation, the chances of producing a new ISA that works are slim.

So in the opening salvos of what will inevitably be a long series of negotiations, the EEC has aggressively tabled its "clear ideas" on a new-look ISA. They are essentially those the International Sugar Organisation (ISO) has been looking at in preparatory meetings which started late last year.

The EEC wants to do away with the

present system of export quotas which can be cut (by only a maximum of 15%) or increased in response to agreed price movements. In its place it seeks the creation of a three-tier pact. The top tier would be a "club" of the 10 major exporters, who account for 85% of sugar output: Argentina, Australia, Brazil, Cuba, Dominican Republic, the EEC, India, the Philippines, SA and Thailand. They would establish a nationally-held buffer stock of up to 10 Mt.

Presumably, given the small membership, this "club" would be able to meet frequently to decide who should hold how much (in the light of crop prospects), and on releases or additions in response to market prices.

The second tier (exporters of up to 500 000 t/year) would have a combination of quotas and limited stock holdings, while the minnows in the market, 70 000 t or less, would be unrestricted.

This plan, say its EEC proponents, has several merits. In the first place the grafting onto the existing system of 5,7 Mt (raw

value) of European sugar would entail unpalatable cuts in quotas. The EEC says it would not be able to sell the idea to its members and doubts whether it would be domestically acceptable in other countries. Co-ordinated management of a stockpile equal to 55% of the world's free market in sugar by the big 10 would also be more effective. The EEC points to the "success" of its own buffer stock system — which has also successfully sunk the current ISA.

Understandably, the EEC's "take it or leave it" attitude was resisted by the major cane growers — who also had to establish bargaining positions for the benefit of their domestic constituencies. Australia argued that stocks were too costly and caused too much "spoilage." It wanted stricter export quotas and wider ISA controls, although it conceded that without EEC membership this would be ineffective. Brazil, pleading for flexibility, offered a midway position: a buffer stock and export/output controls to stabilise prices within agreed target bands.

The Geneva talks are set for the long

haul. The last ISA, agreed in 1977, took three bargaining sessions spread over six months. And the ISO secretariat has wisely booked Geneva for a second round of negotiations in September. That could dim the prospects of a new ISA coming into force on schedule on January 1 next year. As EEC delegates pointed out, getting national ratifications through within the European community alone could take months.

In the market the talks have had little impact. Prices, up 17% in two weeks in London and 15% in New York, have been buoyed by rumours and wet weather in Europe which continues to delay beet planting. France has sown only 25% of its planned hectareage (*Markets* April 22). The rumours from New York are of Russian earmarking of sugar and Cuban covering of its commitments (due to late harvest) in lots of 100 000 t a time. The fact that when the May position closed on Comex the 270 000 t delivered was taken by a single trade house heightened belief that the sugar was destined for Russia.

20/5/83
100 pc loans for

(3) Sugar
Mercury

Indian sugar farmers

Mercury Reporter

LAND Bank loans of 100 percent were available to Indian sugar farmers who had been hit by the drought, it was revealed yesterday.

The loans have been made available after a Government decision to include the sugar industry in its nationwide relief

measures.

Mr Pat Bodasing, chairman of the Natal Indian Cane Growers' Association, said details of the drought-relief loans had been sent to all farmers.

They were divided into categories for consolidation of debts, crop loss and replanting of cane ruined by the drought, he said.

The loans, which had been increased from 80 to 100 percent this year because of a Government subsidy, would rescue sugar farmers, particularly Indian, black and coloured, from financial ruin, because of the worsening water shortage in Natal.

Cane production by these farmers had

dropped by more than 40 percent in the past year, he said.

'Farmers whose losses through drought have exceeded 25 percent of his normal production can apply for a crop-loss loan while farmers whose cane roots have died because of the drought can apply for a replanting loan,' Mr Bodasing said.

15/1/83

SA sugar export commitment failure

3 sugar

Financial Editor
SOUTH AFRICA will not meet its sugar export commitment in the 1983-84 season, Mr Chris Saunders, chairman of the Tongaat-Hulett group, says in the annual report, forecasting that 'optimistic' estimates put the crop at 1.6m tons.

As a result, the industry will not be able to meet all its export commitments from its own crop and will not be in a position to benefit materially from any improvement in the export price, he said.

On top of that there will be a substantial deficit in proceeds for the industry and the already-large R188m Government-backed loans will have to

be increased significantly.

Mr Saunders says that the group's sugar output was disappointing as a result of the eldana borer infestation and poor quality of the cane in the Natal-Zululand area, as well as the drought.

Their share stands at 40.5 percent for the last season compared with 43 percent in the previous season.

But the drought has affected the group's sugar lands more than other operators and while it is not possible to predict the output, it will be significantly lower than last year.

But spending on the new R175m sugar mill at Felixton on the North Coast will bring substantial tax benefits as it is commissioned.

The first stage is in December, when the Empangeni mill will be

phased out followed in 1984-5 by completion when the Felixton mill will be closed.

The project is on schedule says Mr Saunders.

Commenting on the Rorich report into the sugar industry Mr Saunders notes that the industry has responded to the proposals and the Department of Industries, Commerce and Tourism is 'now pursuing certain investigations' before making final recommendations to the minister.

On the International Sugar Agreement, where talks started in May in Geneva but were not concluded, he said: 'Indications are that producers are in favour of introducing stronger price regulatory mechanisms than are embodied in the present agreement.'

In Zimbabwe, Triangle Sugar produced 140 000 tons of sugar and 39,2m

litres of ethanol and forecast output of 180 000 tons and 40m litres this year. There is a problem over the Government's delay in granting a sugar and ethanol price increase.

Hulett Refineries increased its throughput by processing sugar for export on behalf of the S A Sugar Association.

On the results, Mr Saunders said the group's profits will fall this year.

How far they drop below the R150m operating profit earned in the year ended March, depends largely on how badly the drought affects the sugar division, which last year was by far the largest contributor to group profits.

Profit attributable to shareholders was R66 251 000, equivalent to earnings of 116.6 cents a share. The pro-forma earnings, if the merger had taken effect from April 1981, were 138.2 cents.

But no real comparisons can be drawn for eps and dividends as the merger was effective from March 1982.

Dividends for the year, totalling 58 cents a share, were twice covered. The report says that dividend cover is to be gradually increased to 2.5 times, at which stage the policy will be reviewed.

The report shows that despite the increase in total assets from R606m to R1 244m during the past year, a tight hold was kept on balance sheet ratios.

At the year end, borrowings represented 18.1 percent of total capital employed — well within the self-imposed ceiling of 33 percent — and net asset value was 1 206 cents a share against the pro-forma figure at the time of the merger of the Tongaat and Hulett of 1 087 cents a share at

In the longer term, Mr Saunders says he is confident that Tongaat will get back on to the growth track that enabled it to post 13 consecutive years of earnings increases prior to its merger with Hulett.

'South Africa has suffered devastating drought before and will suffer them again. I believe it is necessary to see beyond the present circumstances and to plan accordingly.'



CAPE TIMES 16/6/83

3 Sugar

SA to import refined sugar

By JON BEVERLEY

DURBAN. — South Africa will have to import refined sugar this year, the chairman of the SA Sugar Association, Mr R K Ridgway, said yesterday, disclosing that the local crop estimates for this season, which runs to April 1984, showed a slump of over 25 percent.

Last week a Reuter report said London sugar brokers, E D & F Man, were seeking a ship for a cargo of 12 600 tons of bagged Korean sugar for South Africa to be loaded next week.

Mr Ridgway said reduced production at the sugar mills making refined sugar meant the industry would not process enough sugar to meet the requirements of the local market.

"The sugar industry has made arrangements to import refined sugar to cover the anticipated shortfall."

He said the fall in the crop, now estimated at 1,57m tons, also meant that there would not be enough sugar to meet export commitments.

Overseas customers

"The problems arising from this have been discussed with our overseas customers.

"The industry, which has developed an excellent reputation as a supplier of high quality raw sugars to world markets, has received full co-operation from these customers with regard to its proposals to substitute sugar from other countries to meet their import needs."

Mr Ridgway declined

to expand on his statement or to disclose the tonnages involved.

In a normal year the sugar industry needs about one million tons for domestic use and has in some years sold over one million tons abroad.

In the 1981-82 season when 2 055 441 tons were produced some 842 185 tons were exported and 1 152 027 tons used domestically. The 1982-3 season which ended on April 30 saw a record output of 2 125 993 tons.

3 Sugar
17/6/83
20M
Hulett's is set to lay off workers

DURBAN. — Drought-hit Tongaat-Hulett's sugar division, with four of its six sugar mills to close after only 11 weeks' milling, would be forced to lay off workers, the managing director, Mr Dick Ridgway, said yesterday.

And with this season's crop estimate slumping more than 25%, South Africa will have to import refined sugar this year.

Mr Ridgway said the number of workers who would be laid off was not known yet, but they would be offered unemployment pay of 70% of normal wages for up to six months.

He said the offer had been regarded as generous and had been accepted by all the trade unions.

Mr Ridgway stressed that no wages would be cut, as had been reported earlier, and all in employment would continue to earn the same wages.

Laid-off workers would receive normal leave pay for all leave due to them, he said.

Thereafter, for as long as they were unemployed, they would get 70% of their normal pay, resuming full pay if signed on again.

Pension contributions would not be deducted from the unemployment pay — the company would pay employees' contributions as well as its own.

A trade union spokesman said the industry had been "very fair" about the situation, consulting registered and unregistered unions.

The directors of Natal's other main sugar industry employer, C G Smith, could not be reached for comment. A labour specialist said, however, C G Smith was not as badly affected, because the Natal South Coast had not been hit as hard by drought.

The acting general manager of the Durban Chamber of Commerce, Mr J Aikman, applauded the decision to lay off workers rather than retrench them. — Sapa.

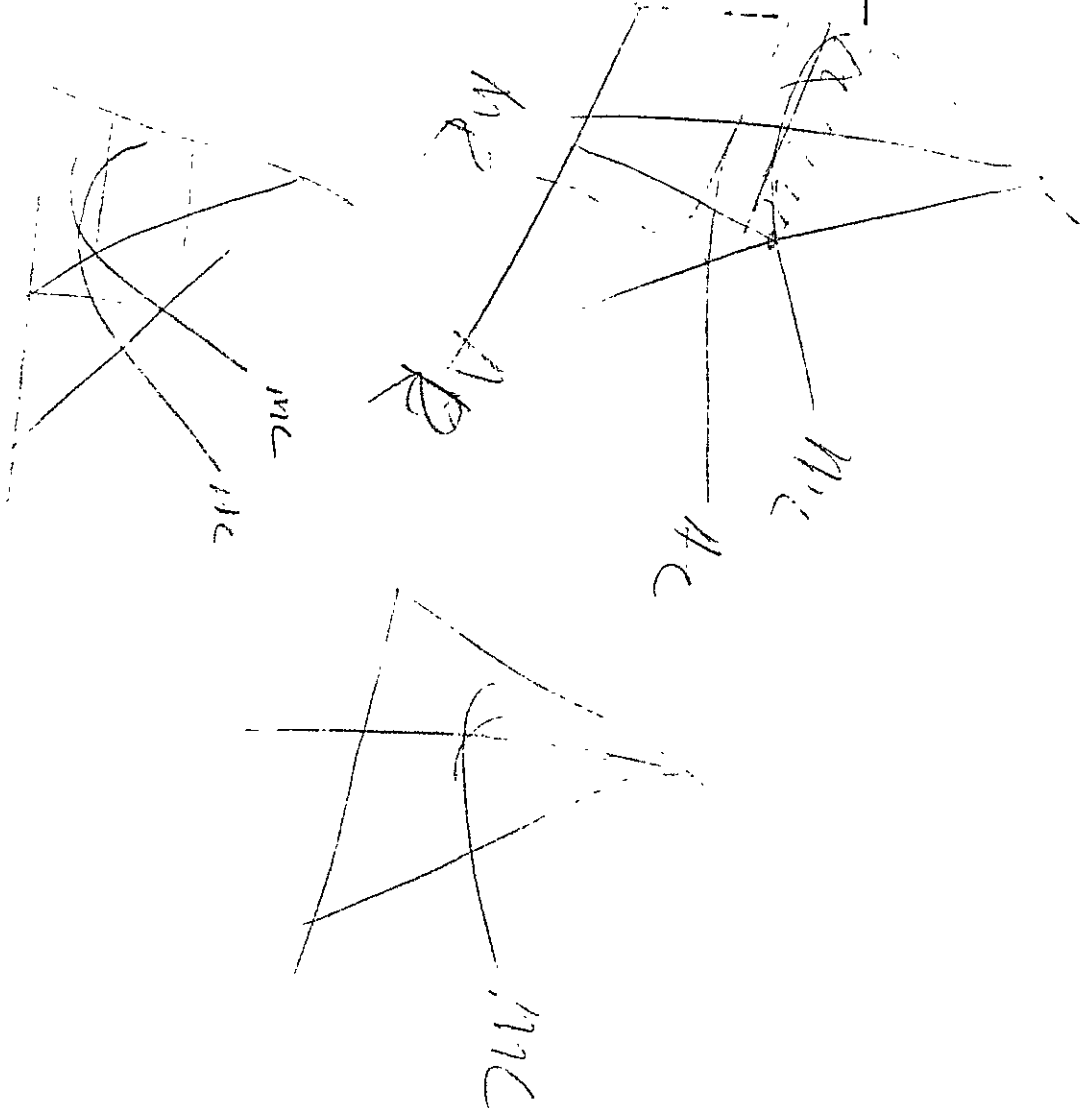

Sugar mills closure will hit commerce

WITH the income of 2 000 of Zululand's sugar workers being cut by 30 percent, trade and commerce will be hit in the area by this week's decision, disclosed yesterday by the Mercury, that four Hulett Sugar mills close next week.

But the Umfolosi sugar mill has chosen a five-day week and intends to work until December while at the Glendale mill, west of

Stanger, they will be 'carrying on' and Smith Sugar's mills are running as normal.

Mr Lourens Kotze, Town Clerk of Empangeni, said the borough had considered the implications of the Hulett move for the area.

But he said the area was fast-growing and there were plenty of employment opportunities, especially in the construction industry. There are a number of large contracts in the region which should be able to absorb many of the unemployed workers, he said.

Impact

Mr Bill Byrnes, Stanger's Town Clerk, said he had not been able to establish what impact the move would have on the town.

He had had informal discussions with officials from the mills and thought it likely that the lower rates of pay would effect the purchasing power of the workers.

As Stanger was a major trading centre in the region, this could have an adverse effect on the town. But Mr Byrnes said it was difficult to determine the exact buying needs of the workers and the level of a possible decrease in spending was impossible to predict.

Mr J. Bales-Smith, general manager at Umfolosi, said they would mill about 711 000 tons of cane, instead of the normal 1m to 1.2m tons. They had opted for short time working, with two days off each week so as to mill the cane at its best period in September and October.

Basic wages would not

be affected but overtime and call-out pay would fall away in this period.

Smith Sugar spokesmen were not available for comment but I understand that they are not having any serious problems with the drought. They have a mill at Pongola using irrigation water and another at Jaagbaan, near Wartburg.

Their other mills are south of Durban, where the drought has not been so great.

Hulett Sugar workers affected by the drought in Northern Natal will be having a holiday until De-

ember Mr Dick Ridgway, managing director, of the company said, spelling out the mill closure arrangements.

The sugar mills are at Felixton and Empangeni near Empangeni; Darnall north of Stanger and Amatikulu at Gingingdhlovu.

Full pay

Mr Ridgway said the mills would close next week. All workers would take whatever leave was due to them on full pay and this would be followed by leave on 70 percent of their pay for up to six months.

The situation would be reviewed in December.

Mr Ridgway emphasised that there would be no retrenchments, that the company would pay contributions to the pension funds during this period and that each worker had been guaranteed a job at the end of the leave.

The details were discussed with the trade unions representing the workers who agreed to the terms of the paid leave on Tuesday.

3 Sugar Mercury
Financial Editor 17/6/83

SUGAR

FM 17/6/83

Taking a caning

③ sugar

The drought has left SA's troubled sugar industry with more problems than most people realised.

For the first time in 10 years, sugar will have to be imported for local consumption; the industry is said to be looking for a new loan of R150m which will bring its total debt to well over R300m; and SA agents have already bought stocks furtively abroad to fulfil export contracts.

Arrangements have been made to supply SA's major customers — Japan, Canada and Israel — with the substitute sugar from other countries.

The financial consequences will be another massive deficit this season. If the R150m loan comes off, the overall debt burden will be R338m.

Last year, the deficit before borrowing — after more than a year of drought — was R150m, due largely to low export and domestic prices. An additional R58m then had to be borrowed which brought total indebtedness to around R188m.

The latest crop estimate for the 1983-1984 season is 1,57 Mt, roughly half normal production. Last year the industry produced 2,1 Mt. Normally the local market consumes 1,2 Mt, leaving a surplus for export of about 1 Mt. But this year, it is doubtful if even the local market, which has first call, will be satisfied.

The problem appears to be the nature of the rainfall pattern. Growers in southern Natal, where the rainfall has been reasonable, should harvest near-normal crops. Farmers in the north, however, where most of the "white end" (refining) mills are situated, are expected to harvest as little as 5% of their normal crop. Even with Hulett's central refining facility at Mobeni working at full capacity, white sugar production may well not meet local demand.

South African Sugar Association (Sasa) export manager David Hardy says additional white sugar will have to be imported. At this stage, he adds, it is impossible to say how much will be required, but it will be used only for "topping up."

Meeting long-term export contracts from meagre supplies presents an additional headache. Hardy says Sasa officials have been overseas to explain the position to major customers. Most have agreed to accept substitute sugar, generally lower than SA quality. But there are still loose ends to be tied up.

The precarious nature of SA's sugar stocks has been one of the best kept secrets in international sugar circles. Seeing what was coming, Sasa bought sugar surreptitiously on world markets at favourable

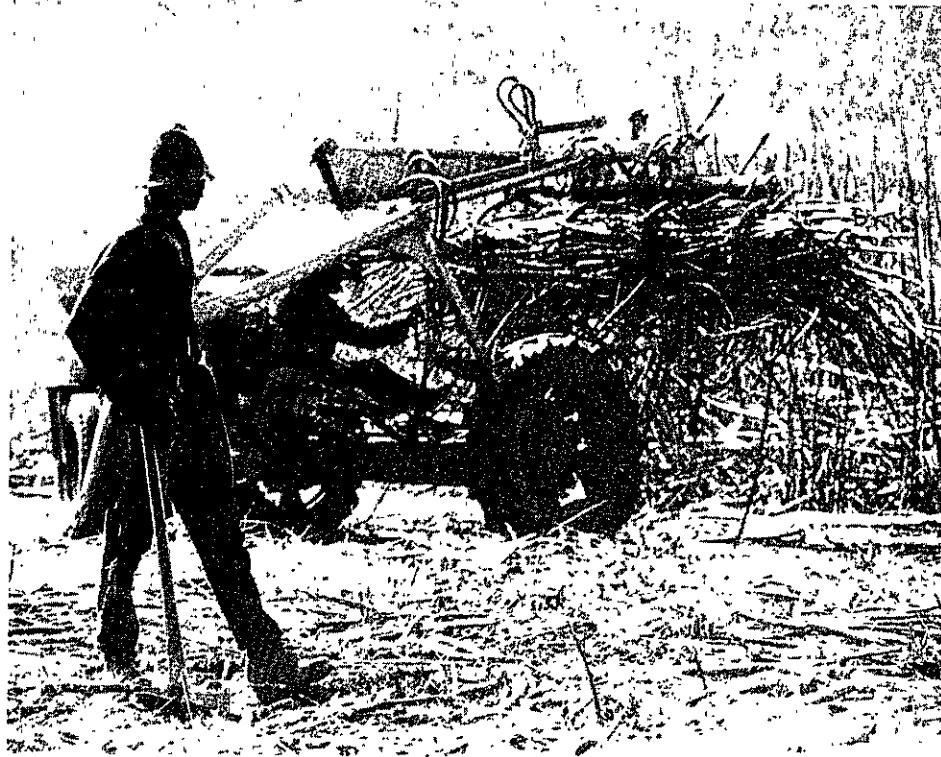

Sugar cane farmers ... watching their losses grow

prices. It feared that when word of its own parlous supply position got out, the price would spiral — which it has. This week the price of raw sugar was quoted on the London market at £170/t — its best level in about a year.

Ironically, however, the high world sugar price is unlikely to help the SA industry over its current difficulties. It simply

doesn't have the stocks to sell on the export market. "We seem to be caught in a cleft stick every time the world price takes off," says Hardy.

SA Cane Growers' Association chairman Laurie Gordon-Hughes confirms that growers are under "tremendous strain." But the recent decision to offer farmers Land Bank loans to allow them to consolidate their

debts and repay over 22 years will help their cash flow situation.

The problem, says Gordon-Hughes, is that with growers receiving only half their allowable return on capital, their ability to repay is constantly being eroded.

He believes forced sales and insolvencies are likely. As a possible solution, Gordon-Hughes advocates the abolition of price control. Alternatively, government should allow a substantial increase in the domestic price.

But rather than have local consumers foot the entire bill, he says a combination of government subsidies, soft loans and a price hike may be more appropriate

Generous Huletts pay-offs

CPM 2/16/82

~~CPM 2/16/82~~

5 Sugar

~~CPM 2/16/82~~

~~CPM 2/16/82~~

ABOUT 2 000 workers at four Huletts-Tonga sugar mills were retrenched yesterday when the mills closed as a result of the drought — but the workers received one of the most generous retrenchment deals since the recession began.

They are to be guaranteed 70% of their normal pay for up to six months and the employers' contribution to their pension fund as well as guarantees that they will be re-employed when the mills re-open.

The retrenchment is the result of the closure of the company's Amatikulu, Felixton, Darnall and Empangeni mills.

Sapa reports that "in the event of early spring rains", the mills would re-open and the retrenched workers would be re-employed.

It is believed that the retrenchment deal offered the sugar workers is the most generous granted during the current recession.

Some companies do not pay retrenched workers any redundancy pay at all and most settlements in the event of the closure of a factory vary from one week's pay for every week worked to one day for each week.

to R12-million
 Another PFP councillor, Mr Geoff Stark, said one of the reasons for the big surpluses were that estimates were "padded" to allow for increases
 The PFP councillors requested that in view of expected huge surpluses the management committee should review the council's income and expenditure after six months
 Such a review would indicate whether it was possible not to pass on mid-year increases in municipal tariffs to ratepayers and whether these increases could not be absorbed by the council.

die increases during the year by Escrom and the Rand Water Board

yesterday, she plans to start work on a new album before leaving for London.

Hints of sugar price increase

By SIMON WILLSON
 Industrial Editor

THE sugar industry wants South African consumers to pay more for domestic sugar so that production costs of export sugar can be reduced.
 Preparing the ground for further increases barely four months after the last hike, Mr Frank Jones, chairman of the South African Sugar Millers' Association, said yesterday the world sugar market could not support the South African sugar industry's full export price.

Speaking at the association's annual meeting in Durban, Mr Jones proposed that the extra export element in the domestic sugar price should be added gradually.
 The industry is worried by consumer reaction to past sugar price increases and by competition from other sweeteners, and wants to change the way the sugar price is increased.
 The industry wants future price increases to be gradual and timetabled to avoid the adverse impact on sales of the present system of occa-

sional, large rises
 If the association gets its way, sugar price increases will be "phased" steadily over a set period of time.
 Rounding-up the industry's position, Mr Jones said the world sugar market was not stable enough to enable the local industry to recoup some of its rising costs through higher export prices.
 "The South African sugar industry cannot be expected to swim against the tide and we have to face the fact that our domestic market must accept into its price a

higher proportion of our fixed costs of production than is the case at present
 "This should be done on a gradual and phased basis to avoid undue disruption in off-take (sales) as well as the substitution by artificial and other sweeteners"
 The end result, Mr Jones said, would be to reduce the cost of production of South Africa's export sugar and "enable it to make a meaningful contribution to the viability of the industry"
 The last sugar price rise was 7,5% in February

g equipment

JUST ARRIVED! FANTASTIC PRICE

DS safety

Dion's Low Price **895**

Dion's Low Price **298**

Dion's Low Price **598**

Dion's Low Price **1098**

Dion's Low Price **1198**

Dion's Low Price **1598**

1	S		A	M	P			B		T		5	
	I			I				A		R		O	
	G									6		E	L
	H	A		E				T		A		D	
				R		9		P	E	A	T	S	
						V		R		Y		10	
	R		T	12	E	13		S				I	
				E		A				14		N	
	V					M		15		A	W	N	
	E			S						C		E	
	R	O		E		17		A	N	K	E	R	

R1 crossword may earn you a R13 000 plot

By IAN REID

THERE is a R13 000 building plot going begging-out at Boksburg at the moment. And it could be yours for the outlay of just R1 - and a little bit of luck. All you have to do is to complete the crossword which appears with this report and you may be the lucky winner.

Not only that, but you will be helping two very worthy charities indeed - Operation Snowball (W O No 273), and the United Cerebral Palsy Association (W O No 03 302 0019)

And it is all so easy to enter the "Win-A-Stand" competition. Just complete the crossword which appears and, who knows, YOU could be the lucky winner of a 768m² stand 1208 at Sunward Park Extension 3, Boksburg, which has a listed selling price of R13 800.

And all thanks are due to the Rivonia Round Table who have organised the competition, and the Johannesburg Consolidated Investment Co, which has donated the stand

Johnnies has been active in township development since 1896 and has made a major contribution to township development in Boksburg. In the past decade it has developed the modern townships of Sunward Park, Freeway Park and parts of Dawn Park.

To date, Johnnies has sold about 2 000 stands in these areas and plan to develop an additional 4 000 stands within the next seven years. Johnnies, with the co-operation of the Boksburg Town Council, ensures that these townships are served by high standard roads and essential services which has resulted in these prestige residential areas

If the association can help in any way, it will, irrespective of age, race or colour, wealth or poverty.

But there is a problem. One area in which there is a most pressing need, as no facilities exist at present, is a permanent home for children who do not respond to treatment, or are not eligible for schooling or are not eligible for training centres, or who are not certifiable.

These children cannot be cared for by the association's present facilities as it is a treatment centre and not a home. Consequently it has to discharge such children if treatment is not beneficial.
 The association has decided, therefore, to build a home for these children who will then be able to receive all the facilities which modern care can provide.

Now enter the Rivonia Round Table No 230 In March last year the Central Transvaal Area of the Association of Round Tables in Southern Africa was asked to raise R120 000 to assist in the building and operation of the project. About R25 000 has already been raised and an effort is now being made to raise the balance. The Rivonia Round Table, newest in the area, conceived the "Win-A-Stand" idea

And Operation Snowball, the Mail's very special operation, exists solely to see that as many people of all races as possible don't go cold during the Highveld winters. Every cent it receives is spent on buying blankets for distribution among the poor.

So here is the ideal way of helping these two worthy organisations. Someone has to win. Go ahead and stake a claim - it costs only a Rand

ACROSS

- 1 So particular ... may be sought for far and wide.
- 3 Really high hope might be placed on a ...
- 6 Snake-like fish.
- 7 ... can, of course, cloud one's vision of things
- 8 Does or says again.
- 11 There's a natural tendency to shun the kind of men described as ...
- 15 Heavy rain could obviously make a marked difference to ...
- 16 To the sensitive person there could be something pathetic about a faded ...
- 17 There are certain features one would expect to find in a typical ...

DOWN

- 1 ... of lover should gladden romantic girl's

- 2 It's decidedly not for a weakling to try to be a ...
- 3 Man who often ... is likely to do so in a cool manner.
- 4 Formal agreement between states.
- 5 Situation of suspense is most unlikely to rattle the man of temperament
- 9 First woman
- 10 Only an exceptional ... would be widely reported.
- 11 A ... often takes a seemingly erratic course
- 12 Actor's first ... remark might give perceptive audience hint that crisis is on the way.
- 13 Male sheep.
- 14 A ... may be used to support a heavy weight

RULES

1. The entry fee for "Win a Stand" is R1 per entry
2. Cheques or postal orders MUST be crossed and made out to THE RAND DAILY MAIL.
3. Photostat copies or same-size drawings of the diagram and border are accepted.
4. Entries close at 5pm on Friday, July 8.
5. Winners will be announced on Monday, July 18.
6. Send your entries - as many as you wish - with your donation of R1 per entry to: "Win A Stand", PO Box 1485, JOHANNESBURG, 2000
7. Entries may also be placed in the special boxes in the foyer of the Rand Daily Mail office, corner Matu and Mool streets, or at SAAN's town office, 29 Kerk Street (between Loveday and Harrison streets), Johannesburg
8. The Editor's decision is final and no correspondence will be entered into
9. Employees of SAAN Ltd, JCL Round Table and United Cerebral Palsy Association of SA and their families are not eligible for entry

South Africa ³ buys Swazi sugar

Review 24/6/83

Financial Editor

SOUTH Africa has bought 100 000 tons of sugar from Swaziland to meet its local and export commitments, Mr Dick Ridgway, chairman of the Sugar Association, said yesterday

He was disclosing details of transactions in which sugar from Korea, Brazil, Thailand and South America will be shipped around the world for South Africa.

He said that the purchases would not mean an increase in costs for the industry.

One quarter of the Swazi sugar would be used on the domestic market and would be sent to the TSB mill at Malelane for processing. Of the rest about 20 000 tons was stored at Maputo harbour and

about 47 500 tons would be railed to Durban and exported.

South Africa had bought 100 000 tons of Korean and Brazilian sugar which would reach the country starting next month with three ships carrying 36 000 tons

Mr Ridgway said that a Sasa delegation had visited Korea, Japan and Canada — the main export markets — to discuss the substitution of South African sugar in their exports.

They had not gone to Israel because they were committed to export bagged sugar, or to America, which would not accept substituted exports. The quantities to meet these needs had been bought

SUGAR

Pity the poor consumer

③ Sugar → ~~②~~

At a meeting this week, sugar planters and millers agreed that a substantial increase in the local sugar price is essential if the industry is to survive its current crop crisis (*Business*, June 17).

Their argument is that SA is exposed to the export market where low prices have prevented the industry from covering its full costs of production and allowable margins. About half SA's annual production of 2,1 Mt is sold abroad.

Increasingly, the world market is being perceived as a residual market where producers, whose own earnings are bolstered by high domestic prices or subsidies, dump their surpluses. SA, so the argument goes, can compete only if its domestic market absorbs a higher proportion of fixed costs than the current price control formula permits.

The industry is known to be unhappy with the 7,5% local price increase granted by government this year. Vice-chairman of the Sugar Millers Association (SMA), Case van der Pol, says an increase of around 15% would be more appropriate.

Much, he says, depends on how government views the international sugar situation. Until now, its attitude has been that the world market is in a temporary trough and that the industry needs only short-term handouts. However, Van der Pol contends that the weight of evidence

suggests that it has experienced a structural change — the recent surge in world prices notwithstanding.

A new international sugar agreement, he admits, could change things for the better. But quota restrictions and the huge sugar surpluses exclude SA from benefiting fully. "We must expect that restoring the balance between supply and demand will be a long and painful process," he says. Withdrawing from the fickle export market does not appear to present an option — though it has been widely discussed. The industry has too big an investment in sugar and international sales, even at their current low prices, to make a contribution to costs.

Chairman of the Cane Growers Association, Laurie Gordon-Hughes, points out that farmers' actual realisation on cane used for export sugar last season

was only R9/t. It was the injection of R46m from the stabilisation fund and R58m in loans that enabled a payout of R22/t to growers.

In the event of a price rise, producers would not want it to come all at once.

Says SMA chairman Frank Jones: "We would want to avoid disruption in offtake as well as substitution by other sweeteners."

The industry may not get all its way, as government is increasingly sensitive to raising administered prices. Moreover, within some years world sugar prices could be buoyant once more, giving SA producers the chance of a killing. So Pretoria will be wary of too big a price increase. Some pressure for a thorough cost and depreciation investigation could also be forthcoming.

But all that is messing about with

symptoms. The only real answer is for government to abolish controls over the sugar industry, especially over price and returns on capital employed. But there must be no protection from cheap foreign imports. Then, if the sugar barons believe it is worth preserving export markets and sitting out the doldrums, they will find the money to do so. Under the present scheme of things, they are asking, with tacit government approval, for the consumer to bear all or part of the cost.

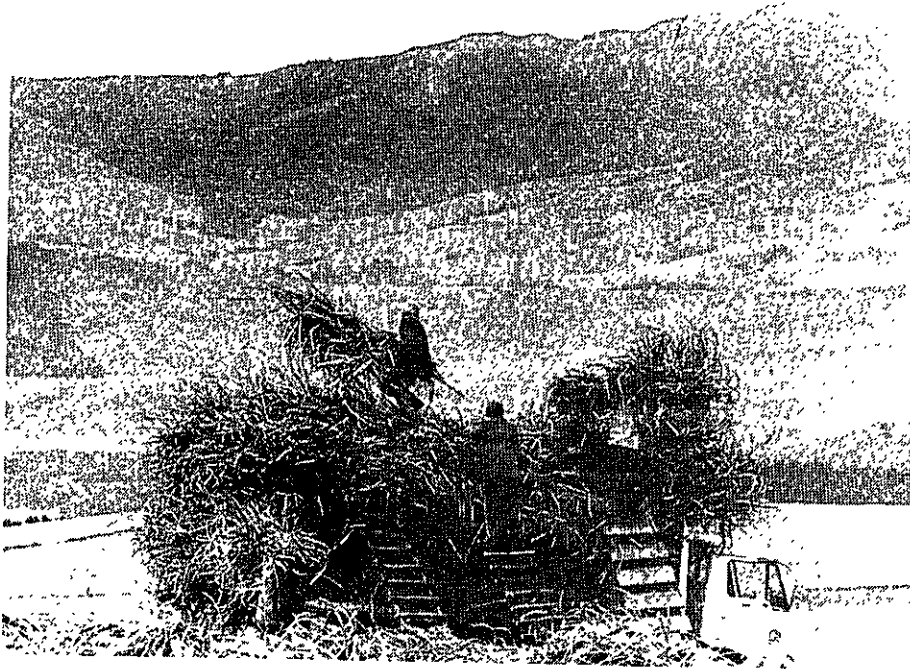

Sugar workers ... labouring for cheap exports

~~File~~ (3) Sugar ~~3~~ ROK 27/6/83

IN many cases, unions have faced employer resistance when they have called for retrenched workers to be awarded redundancy pay.

But it is doubtful whether any emerging union has won a deal as generous as that paid out to 2 000 retrenched workers by sugar giant Hulett-Tonga last week.

The workers, who were laid off when four drought-hit mills closed, will get 70% of their pay for up to six months, the employer contribution to their pension fund and re-employment when the mills re-open.

This is a good deal more than the Government allows workers to claim from the Unemployment Insurance Fund, to which workers themselves contribute.

(3) Sugar
Sugar

not

Industrial

SO

Wick 8/6/83
sweet

SOUTH African sugar exports look set to take a dive this year as a result of the drought pushing up production costs, writes Kathy Gibson.

Frank Jones, chairman of the SA Sugar Millers' Association said that since the export market was very competitive, SA would be forced to market sugar for less than the cost of production.

This would put the onus on the domestic market "to carry more of the cost than it presently does".

Jones said that the increase in local prices "would have to be a phased and gradual process in order to avoid violent fluctuations in demand".

The Association has already borrowed R188-million and will probably have to borrow more before the end of the season.

"No workers have been retrenched or mills closed as yet," said Jones.

"However, our production this year is 600 000 tons down on last year's and, because of the lack of cane, some mills may have to close down temporarily," Jones said.

③ Sugar 1983

SALDRU
SCHOOL OF ECONOMICS
U.C.T.



A Bridge to the Future

The South African Sugar
Association

Small Cane Growers
Financial Aid Fund

Sugarcane producing and potential sugarcane producing areas of KwaZulu.

- ▨ Natal
- KwaZulu
- Denotes Sugar Mills
- Situation of KwaZulu Sugar Potential

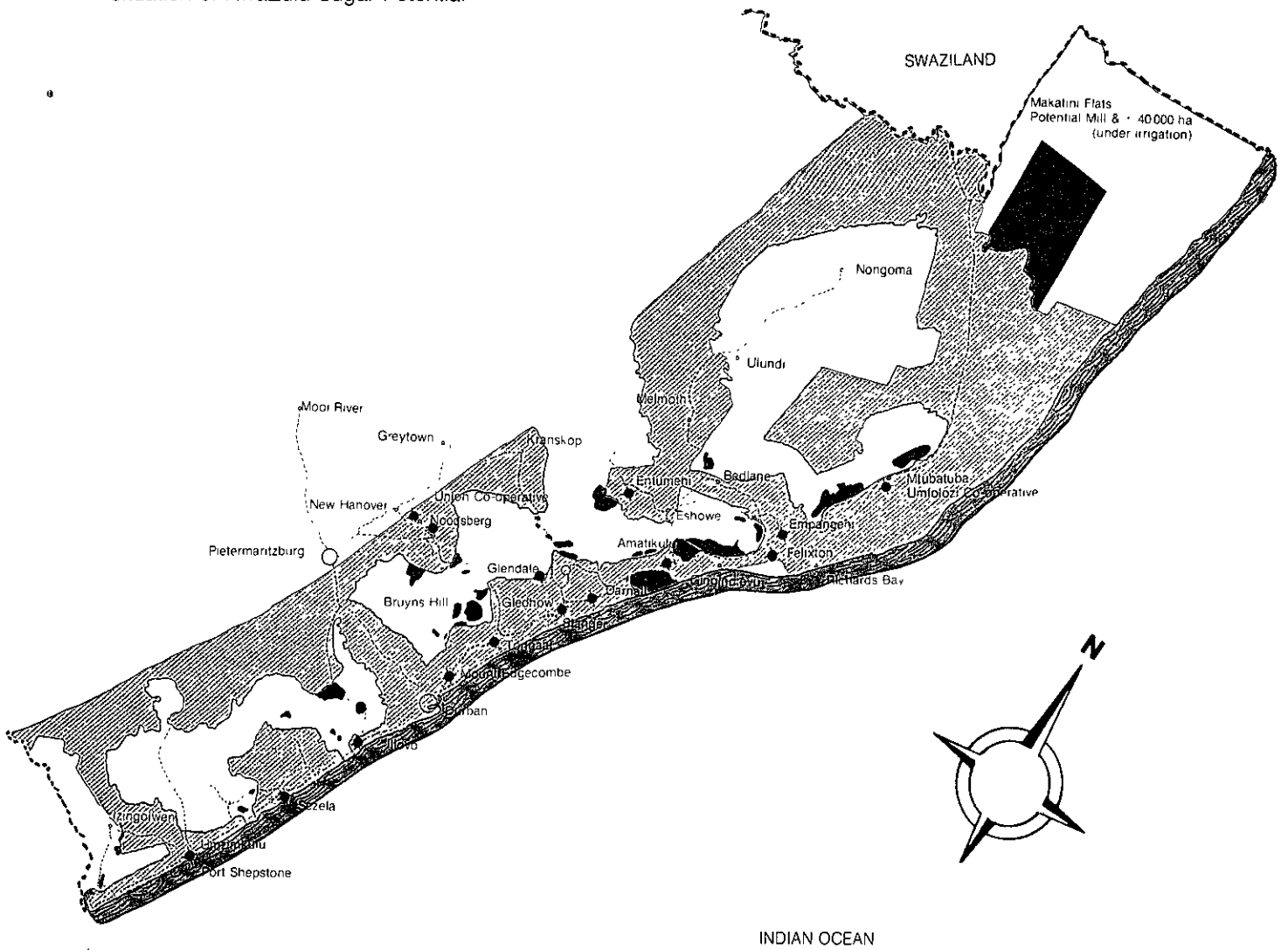

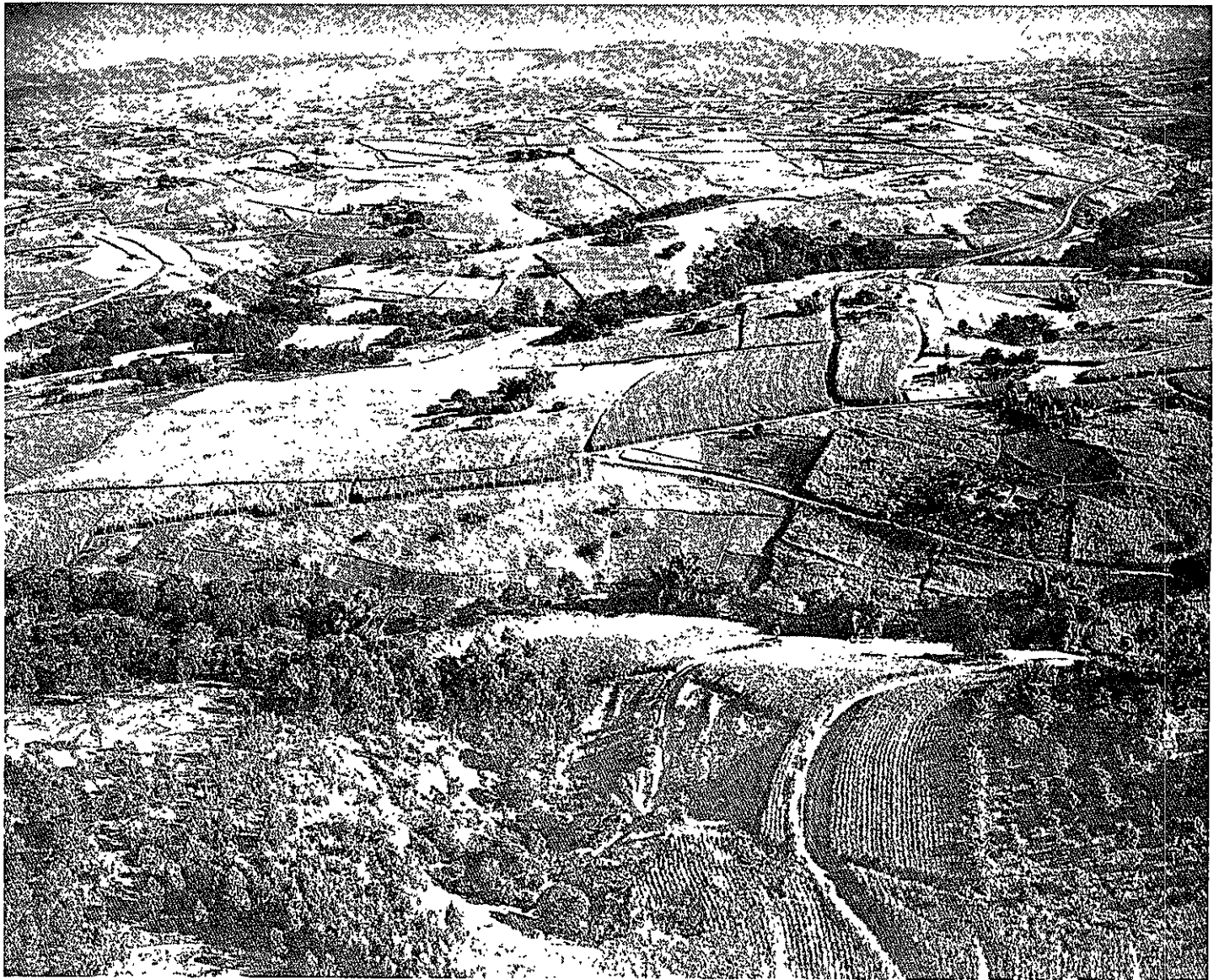

A bold initiative

A unique initiative, launched by the South African Sugar Association in 1973, and aimed at stimulating rural development, is helping bring new prosperity and ever improving living standards to thousands of Zulu, Indian and Mangete (Coloured) cane growers and their families.

The Small Cane Growers' Financial Aid Fund offers practical assistance to "small cane growers" or "developing members" of the South African Sugar Industry. A small cane grower is, by definition, one whose average delivery of sugarcane over the previous two seasons has not exceeded 1 000 metric tons and who does not normally have access to the credit facilities offered through commercial banks or other conventional sources of finance.

The project allows growers to obtain capital to fully-develop the potential of their cane lands. It operates on revolving credit with growers repaying their low interest loans over a maximum period of ten years as they reap their crops. Repayments, in turn, provide finance for new loans.

Loans provide for land development, fertilizer, seedcane, weed control and equipment.

The interest rate will fluctuate depending on conditions in the financial market but will be retained at the lowest possible level.

Although the Fund is operated on a non-racial basis, loans have all been to either Zulu, Indian or Mangete growers.

By the end of the 1981/82 season the Fund had advanced more than 10 000 loans amounting to R13,3 million.

A large number of loans have been made to Zulu growers which has given rise to a substantial increase in the area planted to sugarcane. Together with the increase in area there has also been a significant increase in the productivity (tonnage of sugarcane harvested) per hectare cultivated as a result of the use of improved inputs which have been made available by way of the loans offered by the Fund.

The Fund functions in close co-operation with the KwaZulu Government and has demonstrated that the public and the private sectors can work together for the benefit of the community which they serve.

The benefits of sugarcane production are not only related to the

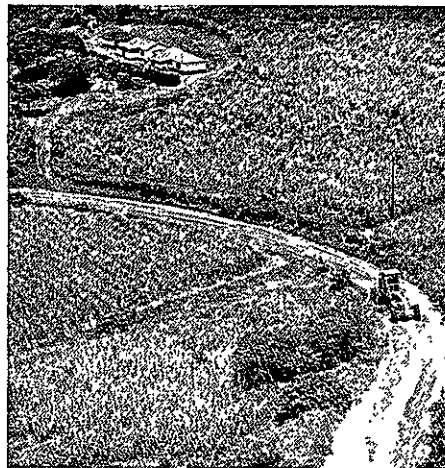
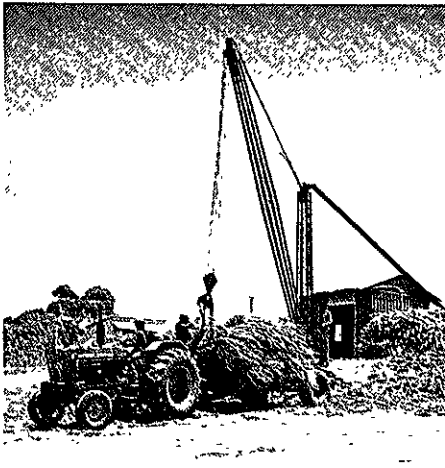

improved financial returns realised by the small growers but may be seen in all aspects of life in the rural areas associated with its production:

- Roads and bridges constructed for the removal of sugarcane have improved transport facilities and increased the viability of rural trading centres in the vicinity.
- A sound base for the establishment of agricultural contracting and transport businesses has been created as well as opportunities for other service industries.
- Urban unemployment has its roots in rural unemployment. The greater the

number of opportunities that can be offered to entrepreneurs in the rural areas, the more employment will be created in agriculture and related services.

The establishment of sugarcane growing in KwaZulu has shown that, given the necessary infrastructure, an assured market which gives an adequate profit incentive for both the producer and the processor, and an enlightened and enthusiastic administration, a revolution in the field of development can occur with far reaching beneficial results.

The administration costs of the Fund

are not borne by the Fund itself but by the Sugar Industry. Thus, all the resources at the command of the Fund are directed towards its objectives.

The Fund does not simply provide monetary aid — it is essentially a development agency. Development is concerned with people — with improving the quality of life — and the Fund's primary aims are to raise the productivity of small cane growers and to promote their economic advancement. As self-reliant members of the community they may lead richer and more satisfying lives.





Development

At its inauguration the Fund recognised a number of obstacles to development but did not become despondent, having accepted that quick and dramatic solutions were not possible.

The results of the Fund's programme have been phenomenal. The first loan made by the Fund was during the 1973/74 season when 355 534 tons of sugarcane worth R2,7 million (from 13 289 hectares) were delivered from KwaZulu growers.

The tonnage from KwaZulu now exceeds 1,25 million tons and it is anticipated that this should almost double by 1990.

Approximately 3% of KwaZulu is suitable for the production of sugarcane. Less than half this area —

some 42 000 hectares — was developed by the end of 1981/82 season. When, and if, the total area suitable for sugarcane production in KwaZulu is developed, income from sugarcane could represent more than 25% of the agricultural income of KwaZulu.

Most of the area suitable for sugarcane in KwaZulu is dry land but certain areas have potential for irrigation.

In KwaZulu, while the Fund's assistance is important to the individual small cane grower personally, it is also significant in terms of the contribution it can make to the economic development of KwaZulu. For the 1981/82 season Zulu growers received more than R25 million, and at

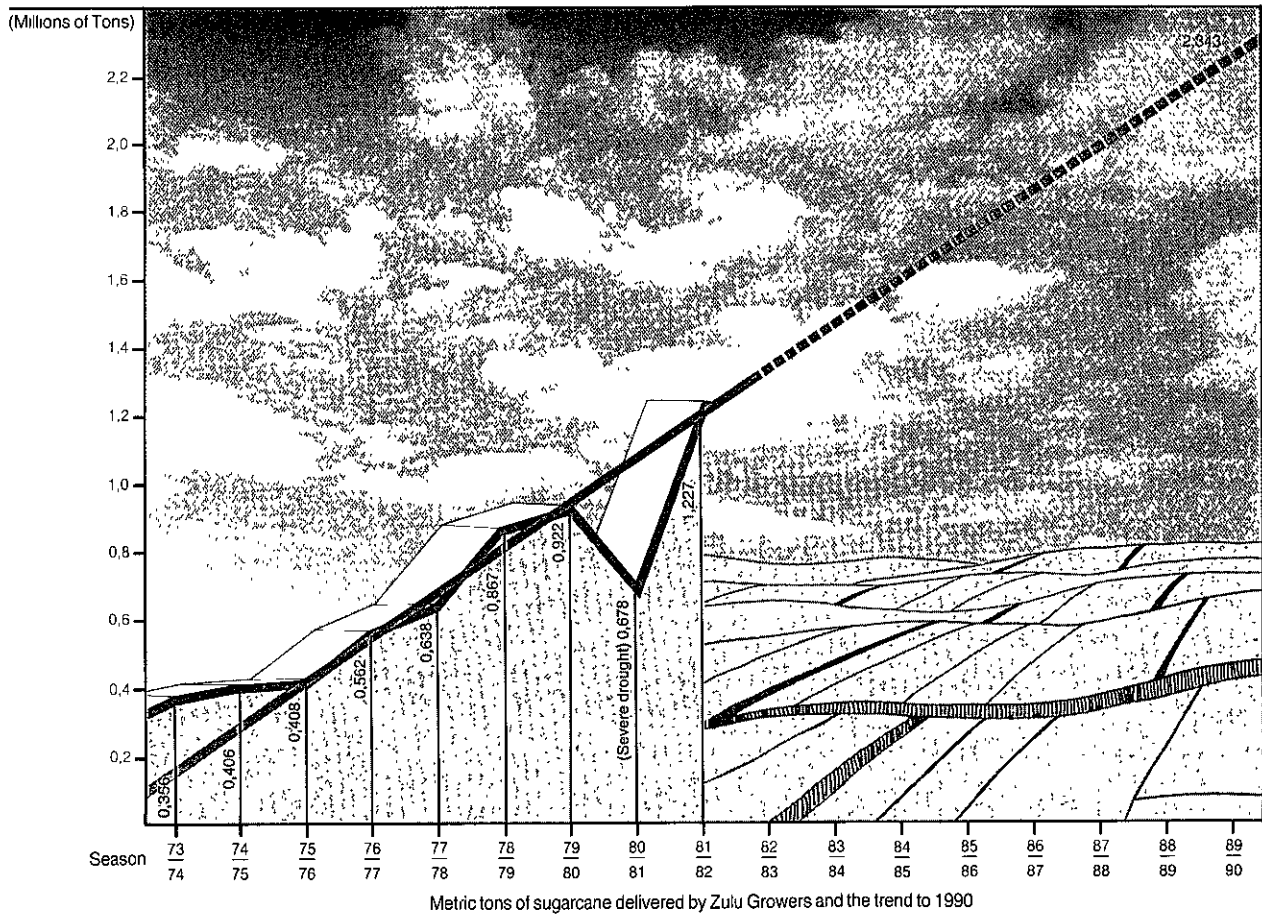

present day returns the value of the crop in 1989/90 will exceed R42 million.

Development in KwaZulu is approached in several ways, but the end objective is to establish an independent farmer in an area which is planned for economies of production. For example, instead of producing sugarcane on scattered units, an area is usually consolidated

into a block or blocks which allow for efficient infrastructure utilisation. This consolidation into blocks is done both on a formal and informal basis depending on the social structure and the initial method of development.

Development in the small farmer sector of the Sugar Industry has not been divorced from the difficulties prevalent in most parts of the developing world.

In respect of KwaZulu the most common problems which beset development in sugarcane producing areas are:

- a high population growth rate
- fragmentation of agricultural land
- a traditional tribal system of land tenure
- adherence to traditional beliefs and social structures
- a low level of education

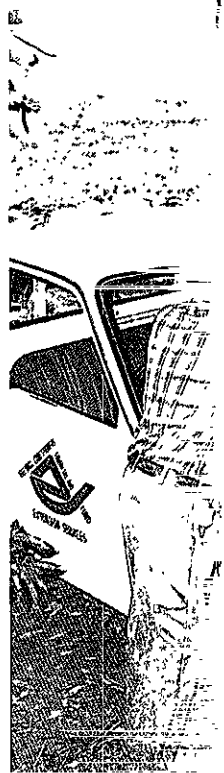

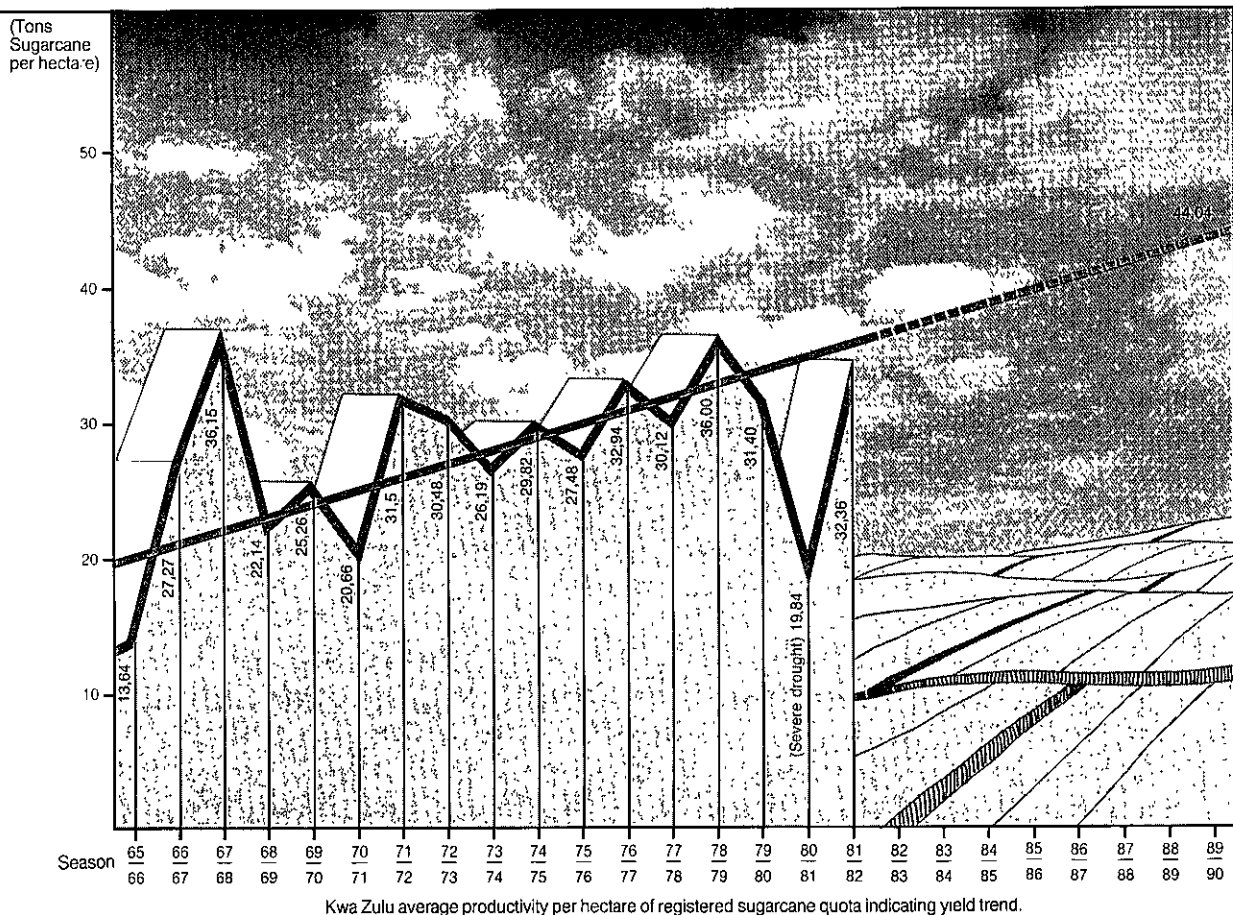

Kwa Zulu average productivity per hectare of registered sugarcane quota indicating yield trend.

- the migration of workers to urban areas.
- Economic necessity dictates that the people of KwaZulu become involved in an adaptation process. The Fund has always held the view that people are generally not resistant to change if they participate in the decisions leading to the change.
- This has led to a decentralized administration with local

representatives on local committees and sub-committees.

Problems commonly found in developing areas are receiving considerable attention in the sugarcane producing areas. Although there may still be bottlenecks, a high degree of success is being attained in either eliminating or reducing:

- insufficient marketing facilities
- insufficient infrastructural development
- a lack of credit facilities.

In doing so close co-operation has developed between the Fund, sugar milling companies and the KwaZulu Government's Department of Agriculture and Forestry.

Sugar milling companies assist with many services which smooth the way to an efficient marketing system. Cane transport, particularly, relies on a well planned infrastructure of access roads, loading zones, bridges and main haulage routes provided by the KwaZulu Government with the Small Cane Growers' Financial Aid Fund providing the necessary credit facilities.

Creating access to areas for sugarcane development, providing the necessary milling facilities and injecting the essential capital has led to economic development of the community and improvement of many other facets of rural life. Entrepreneurs are emerging and providing services which are now in demand — transport services, contracting services and

supply stores to mention only a few.

Employment potential in sugarcane producing areas has increased to the degree that there are labour shortages at certain times of the year.

The situation in the Indian and Mangete sugarcane growing areas, although slightly different to KwaZulu, due in the main to the nature of land tenure, is also improving. As a result of surveys by the Fund to determine difficulties encountered by these growers, extension services have been implemented.

The yield of small farmers has averaged well below the industrial average. However, a trend is now discernable which indicates a steady increase.

The trend was affected adversely by poor rain distribution in the 1979/80 season and a severe drought in the 1980/81 season. The increase in production, which is accounted for by the improvement in husbandry techniques, still has scope for improvement and it is in this area that extension services and education will have further significant results.

With the present commitment by the KwaZulu Government and the Sugar Industry, the yields should continue increasing until parity or near parity with the Industrial average is reached.



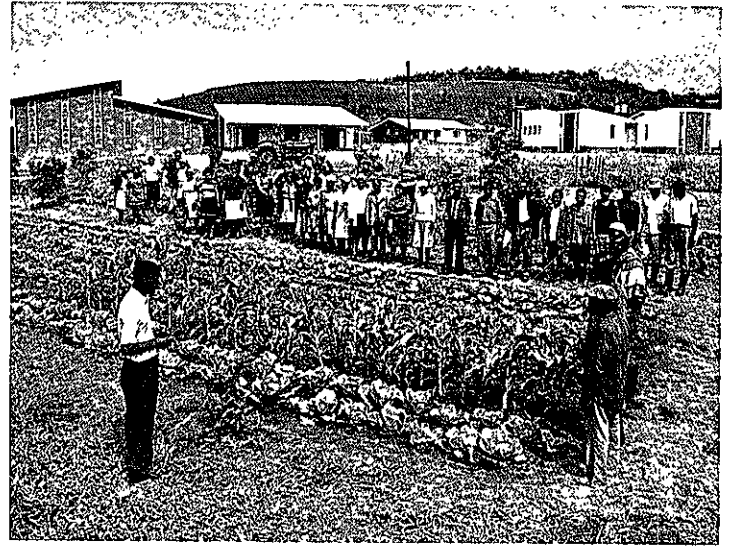

Education and extension services

Development involves much more than the process of providing monetary aid. Financial assistance is of short-term value while knowledge and skills are permanent. If small growers are to respond to the new opportunities, they require a higher level of training and agricultural knowledge. The Sugar Association Small Cane Growers' Financial Aid Fund recognises that extension services are an essential complement to financial assistance. In consultation with the KwaZulu Government, three Farmers' Centres have been built in KwaZulu where Farmers' Days and courses on sugarcane husbandry and agriculture, bookkeeping, the economics of agriculture, and servicing and maintenance of tractors and farm equipment, are held.

The Farmers' Centres were constructed in 1975 at a cost of R587 000. They were donated by the Fund to the Government of KwaZulu which staffs, administers and maintains them. The Centres also provide a suitable venue for conferences of non-agricultural organisations. They have become Community Centres in addition to their primary function as centres of gravity

of the agricultural sector.

Whenever possible, appropriate courses are offered to farmers' wives. These courses include home economics, child care, music, arts and crafts, and family relations.

The KwaZulu Government has appointed a number of Zulu Extension Officers to the KwaZulu cane belt. They accompany their cane farmers to courses at the Centres and carry out the follow-up work which is so important.

On 1 September 1974, the Fund appointed an Extension Officer to work among Indian sugarcane growers. For the Indian and the Mangete small cane growers, the Fund also introduced a mobile extension service.

The Mangete cane growers decided to build a Community Centre and offered to make this available for Farmers' Days and courses in sugarcane husbandry. The Fund made a cash donation to help with the cost of the Centre.

Provision was made in the Fund's budget for study/travel grants to those with leadership potential to study what is being done in other parts of the world for the development of rural communities.



Finance

The Small Cane Growers' Financial Aid Fund started with R5 million in 1973. The initial grant by the South African Sugar Association was increased by an injection of a further R1 million in 1979.

The growing demand for assistance, combined with the erosive effects of inflation, resulted in the R6 million financial base not being sufficient to meet development costs.

To overcome this problem the Fund approached sources outside the Industry to raise additional finance. The first three loans raised by the Fund amounted to R5,0 million. Although raising funds from outside sources the Fund will, at all times, attempt to give a favourable rate to its borrowers.

When the Fund was established, and until April of 1981, a fixed rate of 3% for the first four years of a loan and 5% for the remaining six years of a loan was charged.

As from May 1981, interest rates on loans to borrowers have fluctuated according to the Fund's costs in raising the required finance. The rates charged by the Fund will, however, be determined at a level which will benefit the small farmer to the maximum extent possible.

Small cane growers have, on the whole, shown great responsibility towards repaying their debts.

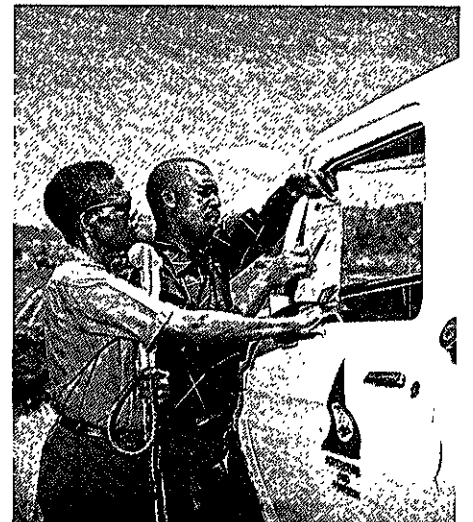

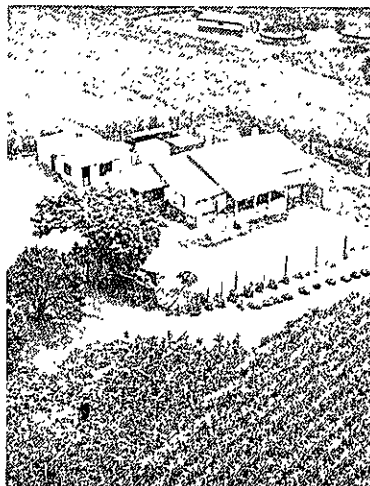

The future

The Fund has attempted at all times to apply and utilise methods of management and development proven in other parts of the world. Important aspects of the Fund's operations which require emphasis are that:

- credit is made accessible to a small grower and he does not have to travel a great distance to obtain it
- credit is tailored to the productivity of a small holder's land unit
- repayment of loans is proportionate to the productivity of a small grower
- education facilities have been supplied and small growers are encouraged to make full use of these
- the full participation of a small holder in rural and community development is promoted.

Sugarcane has established itself as the single most important industrial crop in KwaZulu, helping as it does to develop a sophisticated infrastructure. The transfer of technology is taking place at an increasing rate and the return to the communities involved is increasing.

The benefit of sugarcane production is not only related to the improved financial returns realised by small growers but may also be seen in all aspects of life in the rural production areas.

Roads and bridges for the removal of the sugarcane have improved general transport facilities and increased the viability of rural trading centres.

Urban unemployment has its roots in rural unemployment. The greater the number of opportunities that can be offered to the entrepreneur in the rural areas, the more employment will be created in agriculture and related services.

A need for a financial institution such as the Fund has been demonstrated beyond doubt by the enthusiasm which small growers have shown in their active application of the assistance which has been made available.

STATISTICAL INFORMATION

Loans Advanced each Season by Group of Farmers

Season	Total Number of Loans	Black Rand	Indian Rand	Mangete Rand	Total Value Rand
1974/75	373	387 724	5 440	54 030	447 194
1975/76	984	851 473	95 019	66 739	1 013 231
1976/77	1 832	1 599 968	111 311	13 784	1 725 063
1977/78	1 466	1 452 292	124 136	30 760	1 607 188
1978/79	1 501	1 770 664	69 470	8 669	1 848 803
1979/80	1 320	1 799 898	1 44 740	34 171	1 978 809
1980/81	1 151	1 526 765	133 643	55 897	1 716 305
1981/82	2 020	2 766 414	171 984	7 570	2 945 968
Total	10 647	12 155 198	855 743	271 620	13 282 561

It will be seen from the above table that an amount of R2 945 968 was advanced to small cane growers during the 1981/82 season. This amount is the largest amount loaned by the Fund during a season.

The Productivity of Small Cane Growers - Sugarcane Deliveries in Metric Tons

Season	Black	Indian*	Mangete
1974/75	405 827	913 600	29 968
1975/76	408 400	798 635	27 557
1976/77	561 536	999 826	43 083
1977/78	637 741	919 416	32 202
1978/79	866 703	1 010 214	45 724
1979/80	921 541	844 517	31 085
1980/81	677 738	470 019	21 507
1981/82	1 227 366	971 336	53 159

*The deliveries of Indian growers include both small and large growers.

It will be noted that the production of sugarcane for the 1981/82 season in all instances is approximately twice that of the previous 1980/81 drought affected season. Notwithstanding the evident climatic effect there is a discernable increasing trend being shown by Black and Mangete growers.

SA buys ^{3 Sugar} 2001 9/7/83

Swazi sugar

Own Correspondent

DURBAN — South Africa has bought 100 000 tons of sugar from Swaziland to meet its domestic and export commitments, says Mr Dick Ridgway, of the SA Sugar Association.

He disclosed details of the transactions in which sugar from Korea, Brazil, Thailand and South America will be shipped around the world for South Africa.

He said that the purchases would not mean an increase in costs for the industry.

A quarter of the Swazi sugar would be used on the domestic market and would be sent to the Transvaal Suikerkorporasie mill at Malelane for processing. About 20 000 tons was stored in the Maputo harbour and about 47 500 tons would be railed to Durban and exported.

South Africa had bought

100 000 tons of Korean and Brazilian sugar which would arrive from next month. Imports would end in October.

Mr Ridgway said that a SA delegation had visited Korea, Japan and Canada — the main export markets — to discuss the substitution of South African sugar in their exports.

It had not gone to Israel because SA was committed to export bagged refined sugar. Nor had it visited the US which would not accept substituted sugar.

Mr Ridgway said that there was no application before the Government for an increase in the domestic price of sugar, but it would be made at the "regular" time later this year.

The association would approach the Government with a strategic plan for the industry's long-term future.

1876 (3) Sugar (3) General
Sugar mills may close

JON BEVERIDGE
Financial Editor

MORE sugar mills may have to be closed, Mr Chris Saunders, chairman of the Tongaat-Hulett's Group, said yesterday.

Some weeks ago the group closed some of its mills in the Zululand area because of the drought.

About 2 000 workers at the Felixton, Darnall, Amatikulu and Empanjeni mills were laid off with the promise of 70 percent of their normal wages for the next six months.

97/3/83
A Hulett's spokesman said the group's other two mills, at Maidstone and Mount Edgecombe, might face similar cutbacks.

The milling season usually runs from April to December with a shut-down between January and March.

Mr Saunders said he expected the twin forces of drought and world recession would have a severe impact on the group, but forecast that earnings for the year should not fall by more than 20 percent of last year's 116,6 c a share.

Drought relief sought by sugar farmers

3 *Singapore*
Mercury Reporter
Mercury 27/1/83

AN URGENT meeting is being sought with the Minister of Internal Affairs, Mr F W de Klerk, in a desperate bid to obtain immediate financial relief for hundreds of sugar farmers in the drought-stricken areas on the Natal North Coast.

After talks with the Central Committee of the Natal Indian Cane Growers' Association in Stanger yesterday, Mr Amichand Rajbansi, executive chairman of the South African Indian Council said the drought was having a devastating effect on farmers and many were relying on Government help to rescue them from financial disaster.

Mr S V Naicker, an executive member of the SAIC who represents the Zululand constituency, said farmers in Nanoti, Homebush, Sansusi, Tugela, Darnall, Cottonlands and Imona had been hardest hit by the drought.

He said most of the farmers from these areas who obtained Land Bank loans more than two years ago to overcome difficulties as a result of the last drought had still not repaid their loans and were not in a position to do so because of serious crop losses.

Sugar industry has plan to restore stability

28/7/83

③ Sugar

Financial Editor

Mercury

A long-term strategy to allow the sugar industry to restore its stability and economic viability is being reviewed at present, Mr Dick Ridgway, chairman of the S A Sugar Association, told the annual meeting in Durban yesterday.

It is expected, he said, that it will be sent to the Government by the end of the year.

'The Government's attitude is seen to be positive in this regard,' as shown by the responsible minis-

ter and his top officials visiting the industry in May to see its problems and operations.

dict until greater clarity emerges as to the success of the negotiations for a new world agreement, and perhaps a realistic revision of the statistics relating to world stocks.'



Mr Ridgway sketched a gloomy picture of the industry beset by loans of R188 million and said that these will be increased to meet the drought-induced shortfall this season.

The world sugar price has been rising for three reasons, he said.

One, is droughts and floods in various parts of the sugar-producing world.

Near-record

While last season saw a near-record crop (2,1m tons) the drought has resulted in an estimate for this season of 1 515 000 tons, which is viewed by most in the industry as 'probably on the high side.'

Second, is the speculation that the European beet crop will be 'considerably lower' than in previous years.

Thirdly, positive news has emerged from the sugar agreement talks.

Mr I G B Smeaton (left) has been elected chairman of the S A Sugar Association with Dr C van der Pol (right) vice-chairman. Mr Smeaton is a cane-grower and was vice-chairman to Mr Dick Ridgway, who finished his term of office yesterday. Dr Van der Pol is executive chairman of Hulett Sugar and vice-chairman of the Tongaat-Hulett group.

Mills have had to close in the hopes that they can catch up later in the season should good early summer rains fall.

Mr Ridgway says that it is significant that the world price has risen despite the reported high stocks of sugar.

Stocks

But despite low world prices, Mr Ridgway seems quietly confident that the current talks about a new world sugar agreement — the latest session was this month — followed by a full meeting later this year, will lead to a new and successful system with the inclusion of the Common Market.

There could be two reasons why the price was firming and not stabilising: one was that sugar stocks were not readily available for sale or export and the other was the possibility that statistics did not reflect the true position.

Mr Ridgway's views of the world sugar price is that it is 'likely to remain at a higher, but still unsatisfactory level in the short term; but without the introduction of any new factors the statistical situation continues to be unsound.'

'Sugar economists and statisticians can render the world sugar community a major service by seriously examining, questioning and, if necessary, correcting the statistics on which so much reliance is placed on the interpretation of the world sugar economy,' he said.

'Longer-term prospects are very difficult to pre-

that is the question

Sugar³ heads^{Sugar} for big loss²⁰⁰⁹ 28/7/83

Industrial Editor

THE SUGAR industry will suffer another large deficit in the 1983-84 season, says the South African Sugar Association in its annual report.

A record sugar output was achieved last season, but was not matched by the performance of export prices.

The industry entered the current season with accumulated R190-million in Government-guaranteed loans.

"The supply position for 1983-84 in both the local and export markets will be difficult, but the association has already made arrangements to cover the possible shortfalls," the report says.

There are encouraging signs of a recovery in the export price after poor weather in several major beet- and cane-producing countries.

"It is expected that production will again exceed consumption in 1983, but a reduction in production, accompanied by a recovery in offtake (sales), could bring the market into balance in 1984."

The International Sugar Agreement continued to be ineffective in controlling world supply and demand in spite of the 15% reduction in export quotas.

Positive moves were, however, made at the renegotiating conference in Geneva, and the possibility exists of a new agreement, with the European Economic Community as a member, coming into force at the beginning of 1984.

"Although this could give further impetus to the rise in export prices, the gains to the industry will be overshadowed by the effects of the drought, and it is expected that a further substantial deficit in proceeds will be sustained in the 1983-84 season."

~~113~~ ~~116~~ ~~117~~
~~129~~ ³⁵ ~~130~~
Sugar
Trade
unions
Mercury 9/18/83

THE Industrial Council of the Sugar Manufacturing and Refining industry decided to amend its constitution to provide for representation for trade unions based on their numerical strengths

The decision was taken at a meeting last week in Durban.

In the past, each union in the council was represented by one delegate. The amendment provides for representation to be based on one delegate for every 1 000 members or part thereof.

This will result in the National Sugar and Refining and Allied Industries (NSRAI), employees' union having six delegates in the council with the remaining five unions each having one delegate.

The NSRAI union represents the majority of black workers in the sugar manufacturing and refining industry.

Lonrho expects 30% slump in SA sugar crop

3 sugar risk
20/5/83

Financial Reporter

LONRHO SUGAR expects its South African crop to be cut by as much as 30% this year because of the drought.

However, because of higher world sugar prices and forecast record crops in Swaziland and Malawi, a moderate profit recovery is budgeted for the year to March 1984.

Bottom-line profits of the Swazi-based group slumped from R10 719 000 to R1 793 000 in the past year but the total dividend distribution was maintained at 30c a share.

In his annual review, the chairman, Mr M J J R Leclézio, says "it is fortunate... that the sugar market has staged a very good recovery since April this year".

Although sugar prices are still too low for many produc-

ers, "a substantial improvement in group profits can be expected in the current year".

Sales of Swazi and, to a lesser extent, Malawian sugar have been helped by South Africa's reduced sugar output.

"It is gratifying to note that in spite of the relatively high prices realised from those sales, their net effect has been beneficial to the SA industrial price because of the judicious use made by the SA Sugar Association of the terminal market."

Lonrho Sugar's major problems in the year ahead are the accumulation of stocks in Malawi and the precarious financial situation of the industry in Mauritius, where lower crop yields were returned in 1982-83.

Mr Leclézio says: "It is hoped that some of the mea-

asures taken will result in an improvement of the rail movements to the Mozambique ports, and that a continued strengthening of the world price of sugar will go a long way to help solving our problems in those countries."

The chairman welcomes the progress made at the international conferences held in Geneva and London recently and says it augurs well for the conclusion of an effective international sugar agreement.

"It is hoped... that sugar prices never go back to the low levels experienced in 1982."

Mr Leclézio concludes: "The light can now be seen at the end of the tunnel and we are able to look forward to the years to come with much more faith in the future of the group."

Industry bitter on criticism of sugar

3 Sugar
E. Post
16/9/83

By JENNY CULLUM

THE sugar industry in South Africa is finding criticism of its product a bitter pill to swallow.

"The sugar industry believes in its product. It believes that sugar really does 'put the fun into food' from the standpoint of taste as well as providing mankind with a valuable source of relatively cheap energy in the form of a palatable staple food.

"It is also a well proven and safe food preservative. It is a natural product relying on the great efficiency of sugar cane in converting the energy of the sun into sugar," says a leading article in the latest edition of the South African Sugar Journal.

"It has become increasingly fashionable in recent years for sugar to come under unjustified attack across a wide range of fronts. Absurd claims naming sugar as the trigger for criminal behaviour, or as causing lethargy, hyperactivity, heart problems or a host of human ills are often accorded splash treatment by the mass media," says the article.

"A relationship between sugar and obesity is another popular whipping post to which sugar is frequently shackled.

The current issue of the publication, *American Health*, reports that, since 1960, 60 million Americans have switched from sugar to saccharin because they believed the change would solve overweight problems. Investigation shows, that, on average, the artificially sweetened Americans are getting fatter — not thinner," it states.

The SA (Sugar Association) supports, through membership of the World Sugar Research Organisation, overseas scientific research on sugar and health issues.

"With the one exception of sugar possibly representing one of many factors in dental caries, sugar is given a clean bill of health by genuine and controlled scientific studies," the article claims.

The association makes a "substantial financial contribution" towards promoting good oral hygiene through the SA Dental

Association's National Dental Health Week.

A recent study by the US Food and Drug Administration (FDA) has re-affirmed sugar's generally regarded as safe (Gras) rating in the United States which, according to the journal, is not issued lightly.

"We believe the time has come to give the lie to the faddists, the pseudo-scientists and the cranks who find sugar an easy and convenient whipping boy to blame for many of mankind's ills.

"With a considerable weight of scientific research to support it, the sugar industry intends to vigorously defend its products against unfounded attacks and half-truths in the future," says the leading article.

Unions clash over strike

Nov. 1983.
RBM

Labour Correspondent

INTER-UNION strife has broken out over a strike at the Umfolozi sugar mill at Mthubatha, sparked by workers' rejection of the Government's proposed constitution, says a union official. An statement by another union denies this.

According to Mr Selby Nsibandé, general secretary of the National Union of Sugar Manufacturing and Refining Employees (NUSMRE), 500 workers at the mill downed tools in protest at the Government's plan and in support of demands for union recognition.

A spokesman for the mill said the strike "had political implications" and concerned union recognition.

Yesterday, however, the Sweet, Food and Allied Workers Union (SFAWU) issued an angry statement which gave a different explanation and accused NUSMRE of "intimidatory" tactics.

It alleged the strike had been "provoked" by NUSMRE's demand that certain members of the Federation of South African Trade Unions (FOSATU), of which SFAWU is a member, be dismissed.

The statement alleged that nearly 300 of the mill's workers had resigned from NUSMRE. It said NUSMRE's representatives saw this as a sign of "a massive switch of workers to SFAWU".

As a result, NUSMRE had demanded the dismissal of "certain active SFAWU members" at the mill and "provoked" the strike.

"If a union fails to present the interests of its members, then those workers have a democratic right to join a union of their choice," the statement added.

It said workers at another mill, Umzimkulu, had resigned to join SFAWU

Stayaway halts sugar mills

Mercury Reporter

PRODUCTION at two Zululand sugar mills ground to a halt yesterday after 1 400 workers staged a stayaway in protest against the exclusion of blacks from the new constitutional proposals.

The mills are the Felixton Sugar Mill and the Amatikulu Sugar Mill, both of the Tongaat-Hulett group, of which 'Yes' vote supporter Mr Chris Saunders is chairman.

A spokesman for the National Union of Sugar Manufacturing and Refinery Employees said the workers were protesting about the three-chamber parliament for whites,

coloureds and Indians from which the blacks, who are in the majority, had been effectively left out.

'The workers made it clear that they had no grievances with the management. They were merely demonstrating their dissatisfaction with the new dispensation in the hope that white voters would make the right decision when they voted in the referendum yesterday,' he said.

No violence

Mr Ron Phillips, the group's public relations director, confirmed that 1 400 workers at the Amatikulu and Felixton mills had stopped work

'for political reasons'.

He said the striking workers had been 'well behaved' and there had been no violence. Production had come to a standstill and the management had assisted in shutting down the mills.

Mr Phillips said the management understood the feelings of the workers, who had been subjected to extreme pressure.

The 500 mill workers at the Umfolozi Co-operative Sugar Planters Ltd. in Mtubatuba, who downed tools on Tuesday to protest against the exclusion of blacks from the new constitution, returned to work yesterday.

Treurnicht, CP, put on a... that the... votes cast... situation was... which the whites will be

talking of the... talks with the... he was... need to... base... NRP faces a... of peril of be... by the NP... to be high... agenda re-

Breakfast Quip

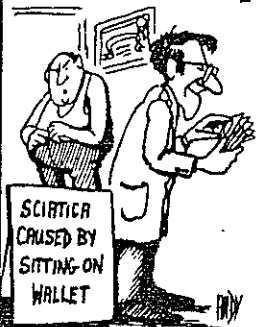

"I knew he'd find some way to relieve me!"

Sugar price control to be scrapped

CONTROL over the wholesale and retail price of sugar is to be abolished, the Minister of Industries, Commerce and Tourism, Dr Dawie de Villiers, announced in Pretoria yesterday.

The industry price of sugar, however, will still be controlled.

The Minister gave his assurance that prices of sugar in the wholesale and retail trade would continue to be monitored for unjustifiable increases.

He added that the abolition of wholesale and retail price control on sugar had been recommended

by the Rorich Committee of Inquiry into the sugar industry.

The recommendation was in line with the accepted policy approach of the Government not to interfere in the country's free-market system.

"A very efficient distribution network for sugar exists in the Republic, as well as strong competition in most areas so that it can be accepted that retail prices determined by demand and supply will be realistic.

"Although the trade margin allowed at present in the retail price

is lower than margins on many other groceries, it is regarded as reasonable, since sugar has a fast turnover and is not subject to ageing and quality deterioration," Dr De Villiers said in a statement.

"In fact, sugar has for a considerable time been sold especially by departmental stores in metropolitan areas at prices generally below the maximum controlled prices.

"After the abolition of price control, no unreasonable price increases should, therefore, occur," the Minister added. — Sapa.

Expert... ia dies

Profesoor... one of... aca... of Soviet af... day. He... paper de... the most... of his... stud... non-com-

Woman's throat slit by mirror shard

By EMIELIA JAROSCHEK
Crime Reporter

A MAN slit a woman's throat with a shard of broken mirror during an argument in a Johannesburg hotel room yesterday, then handed himself over to police as they opened the door.

Mrs Veronica Agnes White, 35, was found lying in a pool of blood in an almost checked hotel room at the Libertas Hotel in Central Avenue, Mayfair, yesterday

afternoon.

Desperate staff in the hotel called police as the woman's screams rang out in the corridors during a hefty fight with the man.

A frantic employee from the hotel finally managed to call two policemen passing in the street.

The men went to the second floor room with the district manager of the hotel growl and opened the door to see the dead woman lying on her back and a

man standing over her.

He held out his hands to police and told them they could take him away.

Detectives who were later called to the scene seized a blood-smear piece of a mirror which had been smashed in the room. Pictures, furniture and blankets lay strewn across the floor.

Staff at the hotel said the woman had recently come out of jail and so had the man who attacked

her. Both had served sentences for fraud and went into the hotel room, which was reserved by a friend, to freshen up.

"Suddenly they started fighting. It seemed to go on and on. Horrible sounds were coming from the room," a hotel employee who did not want to be named said.

The man is being held by Brixton police.

● Picture — Page 2

an already inadequate constitution if it... The Government can immeasurably ha... amongst the coloured and Indian groups... The Government would now have to est... The Government would result in more con... Yes/No question would result in more con... Yes/No question would result in more con... Just as people voted 'No' for different... even conflicting reasons, so too they... meaning of the "Yes" majority was... Dr Slabbert said the Government... treated... I hope that their wishes will not be... "For their sake and for South Africa's... direction... constitution, still saw it as a "step in the... was essential and in spite of the flaws in... secondly because they believed that... feared an increase in Rightwing support... He believed this was firstly because... against the party line... "regret", conceded that a considerable... Dr Slabbert, who accepted the result... prevent racial confrontation and explore

Dr Slabbert said he nevertheless believed... that if the Government interpreted the result... as a mandate for reform and, despite the... flaws in the constitution, tried to initiate re... forms, it was the duty of the Official Oppos... tion to support this momentum... and other obstacles, succeeds in receiving... such co-operation and support from the... coloureds and Asians that it implements the... new constitution, then I will recommend that... the PPP must try to make the best of the... situation under the new circumstances.

CAPE TOWN — There's... many a slip twixt Mike and... Dennis Smith discovered on... tip, as SABC commentator... the 5.30pm Springbok Radio... the opportunity slip of co... operating with us in the... referendum showed poor... political judgment... Mr Marais said the failure of... the CP to withdraw from... the Middelburg by-elec... tion, thus allowing the NP... to win, cast doubt on their... political motives... In addition, the CP leader... who was under severe... pressure and the NRP... would not talk to them till... the CP had sorted out their... own internal problems... Mr Marais said if the NRP... won seats in the next gen... eral election, they would... be prepared to participate... along with coloureds and... Indians... Under the new constitution... It happened, he said, when... Dennis Smith announced that... the Prime Minister had been... "If the Government, despite our objections... tion to support this momentum... and other obstacles, succeeds in receiving... such co-operation and support from the... coloureds and Asians that it implements the... new constitution, then I will recommend that... the PPP must try to make the best of the... situation under the new circumstances.

Slabbert hints at going in if the support is right

A Rand Daily Mail reporter... threatened that he would have his... knocked off his rump" by a female... porter of the CP when he tried to... graph the melee... The NP victory has finally... HNP hopes to take the Middelburg... after the HNP had slashed the NP... jority from more than 5 000 to just... 1 400 in the previous election... CP supporters said they had vot... the HNP in the previous election... protest against NP policy... The HNP received 2 028 votes... the CP ended in the second place... 4 647 votes. There were 75 spoilt... The combined Rightwing vote... to 404 more than the 6 271 votes rec... by the NP.

Violence erupted after about 200 sup... porters of the NP and CP have spent... in an almost festive atmosphere at party... offices sited next to one another... About 38 minutes before the electoral... officer in Middelburg, Mr Lappies La... buschagne, appeared to announce the... NP win at 3.20am, between 400 and 500... supporters of the two parties gathered... on the steps of the town hall... A tug-of-war started when CP sup... porters tried to take posters from NP... supporters who were chanting "Ja, Ja... by chanting "Kaa-Pee" and "Nee, Nee... "Tempers flared and fists started to... fly.

MR JAAP MARAIS, the... leader of the Herstigte... Nasionale Party, yester... day ruled out any immedi... ate talks with the Conser... vative Party leading to a... new political alliance on... the far Right... Mr Marais said he was "hap... py with the situation as it... is" in spite of the Middel... burg provincial by-elec... tion result — where the CP... and HNP, together out... polled the NP — and the... referendum — where pro... portionately the largest... "No" vote was polled by... Rightwingers in the Trans... vatal rural areas... "As far as we are concerned... we are not at all keen on... having further discussions... with these people... The way in which the CP let... the opportunity slip of co... operating with us in the... referendum showed poor... political judgment... Mr Marais said the failure of... the CP to withdraw from... the Middelburg by-elec... tion, thus allowing the NP... to win, cast doubt on their... political motives... In addition, the CP leader... who was under severe... pressure and the NRP... would not talk to them till... the CP had sorted out their... own internal problems... Mr Marais said if the NRP... won seats in the next gen... eral election, they would... be prepared to participate... along with coloureds and... Indians... Under the new constitution... It happened, he said, when... Dennis Smith announced that... the Prime Minister had been... "If the Government, despite our objections... tion to support this momentum... and other obstacles, succeeds in receiving... such co-operation and support from the... coloureds and Asians that it implements the... new constitution, then I will recommend that... the PPP must try to make the best of the... situation under the new circumstances.

Sugar may

cost more

out of town

③ Sugar
4/11/83 Mercury
Finance Reporter

SHOPPERS in remote areas will probably have to pay more for sugar now that control on the wholesale and retail price has been abolished from today, although this should not affect the price of sugar in metropolitan areas.

In a statement yesterday Dr Dawie de Villiers, Minister of Industries, Commerce and Tourism, announced the lifting of control, but said the industry price of sugar would still be controlled.

Dr Frans Oosthuizen, national market and communications manager of the South African Sugar Association, said most stores had been selling sugar at less than the set maximum price and he was confident the trade would act responsibly and prices would not be increased or reduced.

Supply and demand and competition should set the price levels, he said.

No change

Personally I believe there will be no change in prices in the metropolitan areas, although there may be in the more remote areas, where competition is less fierce, Dr Oosthuizen said.

Wholesalers and retailers can now set their own prices for sugar.

But the price of sugar sold by the industry to manufacturers is still subject to control, and prices of products made with sugar, such as soft drinks, will not increase.

Dr de Villiers said prices of sugar in the wholesale and retail trade would continue to be monitored. The authorities would not hesitate to introduce rectifying measures in the event of unjustifiable price increases, he added.

Mr Gordon Utian, managing director of Checkers, said the price would not be increased in his stores, but he thought smaller stores may raise the price in search of greater profit margins.

Dr de Villiers said there was strong competition in most areas and it could be accepted that retail prices determined by demand and supply would be realistic.

Although the trade margin allowed at present in the retail price is lower than margins on many other groceries, it is regarded as reasonable, since sugar has a fast turnover and is not subject to ageing and quality deterioration.

In fact, sugar has for a considerable time been sold, especially by departmental stores in metropolitan areas, at prices generally below the maximum controlled prices.

After the abolition of price control, no unreasonable price increases should, therefore, occur, the minister said.

No change to millers' sugar price

Financial Editor

SUGAR millers are not likely to have their sugar price freed of control — as happened with the wholesale and retail price this week.

An industry source said that while they were hoping that the price would be increased to cope with the combined effects of low world sugar prices and the drought, there were wide implications to such a move and there were no signs, at present, of it happening.

Borrowings by the sugar industry are expected to exceed R200 million by the end of this season.

Changes to the basic pricing system of the industry were another matter, he said.

At present the industri-

al sugar price is determined by the Government and is backed by complex calculations which determine a capital return and profit to farmers and millers.

It is understood that the basic question is being discussed with the Department of Industry, Commerce and Tourism as part of the sugar industry's scheme to draw up a long-range plan.

This was a result of the submission of the Rorich commission of inquiry which was handed to the Government last year.

The Government has not yet responded, officially, to the report which dealt with cane transport and expansion of the cane-growing areas as well.

Sugar 5/11/83

MSK

(3) Sugar R004
12/11/83

Govt set to decide on sugar proposals

Mail Correspondent

DURBAN. — The Government is expected to announce its decision on Monday on the recommendations of the Rorich Committee of Inquiry into the R300-million a year sugar industry.

Mr Peter Sale, general manager of the S A Sugar Association, has confirmed that an announcement is expected next week.

Implementation of some of the Rorich proposals could have a radical effect on the sugar industry.

A decision to expand would demand capital, which, with the industry in the red at present by more than R200-million, would not be easily found unless the Government was able to discover a formula to encourage sugar planting.

The committee was appointed in April 1981 and

signed its report in September last year.

Five areas were examined.

These were expansion of the industry, the effectiveness of the local marketing system, sugar exports, how the industrial price should be determined and "any other matters".

Sugar cane transport was examined in detail and the committee proposed that cane growers would be responsible. This controversial proposal was debated at length in the sugar industry.

One important step has already been taken by the freeing of price control on the retail and wholesale price of sugar.

The industry has been drawing up a long-term development programme and it is understood that this has been discussed in detail with the Government.

15/11/83

3 Sugar

The Cape Times, Tuesday, Nov

Govt accepts all but one Rorich recommendations

PRETORIA. — All but one of the recommendations of the Rorich Committee of Enquiry into the Sugar Industry had been accepted by the government, the Minister of Industries, Commerce and Tourism, Dr Dawie de Villiers, announced yesterday.

The bypassed recommendation was that the Sugar Association be given the responsibility of determining the industry's sugar prices within parameters approved by himself, the minister said in a statement in Pretoria.

The most important proposals made last year by the committee concerned the expansion of the sugar industry and the method of

paying cane transport costs.

"The proposed expansion of the sugar industry has been accepted in principle, on condition that no expansion will be allowed before 1985, and that the quantities for expansion as recommended would not necessarily be adhered to, and would depend on future circumstances," Dr De Villiers said.

As far as cane transport was concerned, it had been accepted in principle that growers had to accept responsibility for the cost of transporting their cane to the mill, he said.

"Those growers who will lose as a result of the new scheme will be compensated on a cap-

italized basis by collecting from those who will gain, until the compensation has been paid.

"Thereafter, growers will receive the full benefit of closer proximity to the mills."

The government was prepared to render financial assistance with the change-over to the new cane transport system.

The implementation of the new scheme and compensation payments would be undertaken by the SA Sugar Association and would come into effect on May 1, next year.

A special arbitration board was being appointed to deal with cases of hardship and matters not covered by the rules of the new scheme, Dr De Villiers said. — Sapa

Falling oil prices

Commodities

Sugar farmers must bear transport costs from 1984

Financial Editor

SUGAR farmers will be responsible for the costs of transporting their sugar cane to the mills from May 1, 1984 the Government announced yesterday in its response to the recommendations of the Rořich Committee of Inquiry.

Expansion of the industry has been frozen until 1985 and a proposal that the S A Sugar Association (SASA) be allowed to determine the industrial sugar price after discussions with the minister has been refused.

All other proposals made in the Rořich report were accepted the Minister of Industries, Commerce and Tourism, Dr Dawie de Villiers, said.

Expansion

He said: 'The proposed expansion of the sugar industry has been accepted in principle, on condition that no expansion will be allowed before 1985, and that the quantities for expansion as recommended would not necessarily be adhered to, and would depend on future circumstances.'

Mr Peter Sale, SASA general manager, had hoped that if the Government gave the industry some flexibility in altering the price of sugar they could avoid the present annual large increases.

'We wanted to be able to have regular, but smaller, price increases. This would confound the speculation that goes on in anticipation of a price increase.'

Mr Sale said the industry would have to accept that there would be no change to the current price-setting policy.

'On expansion of the industry' Mr Sale said that there were, and are, too many imponderables.

'We do not know whether there will be an International Sugar Agreement and if there is what the terms will be; whether there will be quotas and how it will operate.'

'Expansion will be on ice until 1985 when the situation, desirability and extent can be reassessed.'

Mr Sale said that a number of schemes for cane transport had been put forward to the Rořich Committee, who had decided that the cane-farmer would be responsible for the costs from May 1984.

'It is a very complicated matter and because so many people are involved it is impossible to produce a scheme that would please everyone. The association will have to implement this one.'

The Government said that during the initial period there would be a system of the 'winners' paying into a fund from which the 'losers' could draw.

Dr De Villiers said the Government was prepared to render financial assistance with the change-over to the new cane transport system and a special Arbitration Board was being appointed to deal with cases of hardship and matters not covered by the rules of the new scheme.

The implementation of the new scheme and compensation payments would be undertaken by

the S A Sugar Association from May 1 next year.

'Those growers who will lose as a result of the new scheme will be compensated on a capitalised basis by collecting from those who will gain, until the compensation has been paid. Thereafter, growers will receive the full benefit of closer proximity to the mills.'

Mr Sale said that 'in theory' the farmers who 'lost', those furthest from the mills, would receive a capital sum and would then have to assess their situation.

'It would be a free-market position. If there were special factors such as plentiful supplies of water, or good soil which would offset the costs of sending cane to a distant mill, the farmer might continue with his cane.'

The Government's decisions will apply to the Transkei's sugar farmers where 289 ha has been planted to cane and the first cane was milled during September.

Proposals

While the plans for expansion have been shelved the principle has been accepted.

The Rořich Committee dealt with a number of proposals for adding to the cane lands. These included enough expansion (21 330 ha) in the eastern Transvaal and KaNgwane to justify another sugar mill or large extensions to the mill at Malelane.

Substantial plantings were envisaged in devel-

oping areas such as KwaZulu (33 200 ha), Transkei (4 000 ha) and the Mangete (1 000 ha) and KaNgwane.

Smaller areas were suggested at Pongola (2 623 ha) and Highflats in the Ixopo area (3 5630 ha).

Problems under control

JOHANNESBURG—South Africa's 1983/84 sugar crop and exports have been hard hit by drought but customers have accepted substitutions and the situation is under control, Sugar Association manager Peter Sale said.

The Association has asked customers in Japan, South Korea and Canada to accept sugar from other origins. 'Substitutions have gone ahead, and customers have accepted the situation... things are under control,' Sale told Reuters in a telephone interview.

The latest official crop estimate for the season ending in April is 1,41m tons, of which 1,15m is expected to be taken up for domestic needs.

This would make it the worst crop since 1970/71 and compares with last year's record 2,13m tons. Last year South Africa ex-

ported some 950 000 tons, but trade sources say that even with imports for re-export it will not export more than about 450 000 tons this season.

This season it has had problems meeting its export commitments, and trade sources say it has declared a 144 500 ton shortfall from its 850 000 ton International Sugar Organisation (ISO) export quota.

Sale confirmed a shortfall had been indicated to the ISO but declined to give a figure.

The sources say South Africa's shortage of sugar for export has been compensated for by substitutions of around 300 000 tons, by drawing from stocks and by importing sugar — some for re-export and some for domestic use which frees local sugar for export.

They say just over 200 000 tons has been im-

ported this season, some 100 000 tons of raw from Swaziland mainly for re-export and the rest in refined form from various sources such as Brazil.

Although the main sugar growing area in Natal has been very hard hit by the drought and needs rain, Sale said that rain now would actually reduce the crop tonnage by diluting the sucrose content of the cane.

But favourable planting conditions are important for future seasons. Preliminary official estimates put the 1984/85 crop at around two million tons.

South African producers are hoping that the ISO will not reduce the country's 850 000-ton export quota but grant South Africa a 'deemed performance' on the grounds that the drought constitutes exceptional circumstances. — (Reuter)

Bitter-sweet move for sugar farmers

(3) Sugar RDM 17/11/83

Financial Reporter

DURBAN. — Sugar farmers will be responsible for the costs of transporting their sugar cane to the mills from May 1, 1984, the Government has announced in its response to the recommendations of the Rörich Committee of Inquiry.

Expansion of the industry has been frozen until 1985 and a proposal that the SA Sugar Association (SASA) be allowed to determine the industrial sugar price after discussions with the Minister has been refused.

All other proposals made in the Rörich report were accepted, the Minister of Industries, Commerce and Tourism, Dr Dawie de Villiers, said.

He said: "The proposed expansion of the sugar industry has been accepted in principle, on condition that no expansion will be allowed before 1985, and that the quantities for expansion as recommended would not necessarily be adhered to, and would depend on future circumstances."

Mr Peter Sale, SASA general manager, had hoped that if the Government gave the industry some flexibility in altering the price of sugar, it could avoid the present annual large increases.

"We wanted to be able to have regular, but smaller, price increases. This would confound the speculation that goes on in anticipation of a price increase."

Mr Sale said the industry would have to accept that there would be no change to the current price-setting policy.

On expansion of the industry, Mr Sale said there were too many imponderables.

"We do not know whether there will be an International Sugar Agreement and if there is, what the terms will be, whether there will be quotas and how it will operate.

"Expansion will be on ice until 1985 when the situation, desirability and extent can be re-assessed."

Mr Sale said a number of schemes for cane transport had been put forward to the Rörich Committee, which had decided that the cane farmer would be responsible for the costs from May 1984.

"It is a very complicated matter and because so many people are involved, it is impossible to produce a scheme that would please everyone. The association will have to implement this one."

The Government said that during the initial period, there would be a system of the "winners" paying into a

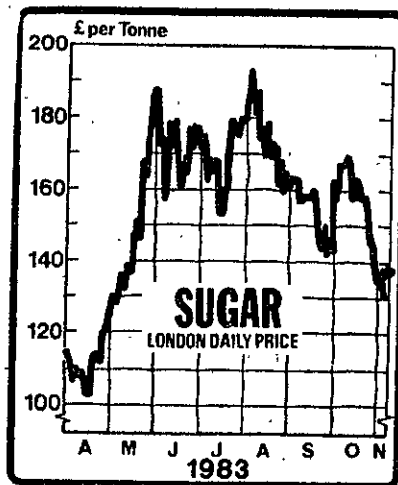

fund from which the "losers" could draw.

Dr de Villiers said the Government was prepared to give financial assistance with the changeover to the new cane transport system, and that a special arbitration board was being appointed to deal with cases of hardship and matters not covered by the rules of the new scheme.

The implementation of the new scheme and compensation payments would be undertaken by SASA from May 1 next year.

"Those growers who will lose as a result of the new scheme will be compensated on a capitalised basis by collecting from those who will gain, until the compensation has been paid. Thereafter, growers will receive the full benefit of closer proximity to the mills."

Mr Sale said that in theory the farmers who "lost" — those furthest from the mills — would receive a capital sum and would then have to assess their situation.

"It would be a free-market position. If there were special factors such as plentiful supplies of water, or good soil, which would offset the costs of sending cane to a distant mill, the farmer might continue with his cane."

While the plans for expansion have been shelved, the principle has been accepted.

The Rörich Committee dealt with a number of proposals for adding to the cane lands. These included enough expansion (21 330 ha) in the Eastern Transvaal and KaNgwane to justify another sugar mill or large extensions to the mill at Malelane.

Substantial plantings were envisaged in developing areas such as Kwa-Zulu (33 200 ha), Transkei (4 000 ha), the Mangete (1 000 ha) and KaNgwane.

Smaller areas were suggested at Pongola (2 623 ha) and Highflats, in the Ixopo area (3 5630 ha).

AFRICA, and especially black Africa, is getting left behind by most of the Third World.

While Asians and Latin Americans have more cash and more food than in 1970, black Africans have less. And while population growth rates are slowing down in many Third World countries, in most of black Africa the rates of growth are still rising.

Most African nations need to perform economic miracles merely to keep up with the flood of new citizens each year.

Exceptions are Botswana, Namibia, Gabon, Zaire and some others where numbers are low relative to natural resources, such as agricultural land and minerals.

The task of providing additional food, jobs, housing, schools, hospitals and so on is made all the more difficult by global recession, high oil prices and growing indifference on the part of the rich nations.

Some would argue that Africa is still comparatively empty and, indeed, the ratio of people to space is relatively favourable.

But who wants to live in the middle of the Sahara or in the heart of the rain forest, with infertile soils and hosts of diseases for humans, livestock and crops?

When we calculate the extent of "favourable" territories, we find that much of Africa is bursting at the seams.

The people overwork the soil, they farm fragile environments where soil and nutrients wash or blow away, they try to raise too many cattle, sheep, goats, camels and donkeys, and they chop down woodlands for fuel.

To make way for landless peasants they over-harvest fish from the Great Lakes of eastern Africa.

There are few people who cause more harm to natural environments than an impoverished peasant: seeing no alternative way to secure the night's supper, and figuring there is no point in considering next year's environment if he is to starve next month, he ravages the basis of his livelihood.

And there are few nations that match the wretched poverty of most African nations, demonstrating the twin theses of the World Conservation Strategy; development obviously needs conservation, and conservation certainly needs development.

If millions of peasants are not helped to improve their lives, they will continue to degrade Africa's environment. (Of course, we must not forget that the affluent citizens of the world waste as much energy each year as the entire Third World consumes.)

So much for the bad news. Now let us look at some better news: forestry, for example.

Trees are a staff of life in Africa because they supply firewood (the predominant type of energy), they help to prevent soil erosion, they exert a "sponge effect" to release water in regular amounts throughout the year and they form "green belts" to stem creeping deserts.



Trees, not tanks, to help Black Africa

3 Pd Timber RDM
19/4/83

Beyond the inhospitable deserts and humid rain forests, much of the African continent is over-grazed and over-cultivated, under pressure from growing numbers of peasant farmers. NORMAN MYERS, who was recently awarded the World Wildlife Fund's Gold Medal, looks at what can be done to protect Africa's besieged natural environment and finds that the prospects are not entirely bleak

But despite these many services, trees are cut down more quickly than forests can restore themselves. This is especially true in the Sahel, where the desert sands creep southwards with every month.

One answer is to plant more trees. But this is more difficult to achieve than one might think.

Villagers have little time for tree-planting, and if Mr X plants 200 trees a day, how can he be sure that when he wants to harvest them they will not have been eaten by goats or chopped down by a neighbour?

Not so obvious, but more effective an answer, is to get the tree-planting undertaken as a community activity so that an entire village protects an entire village's trees.

In sub-Saharan Africa as a whole, the planting rate needs to be stepped-up at least 10 times immediately (the average for the Third World is only five times).

And in the worst-hit areas, such as the Sahel, Kenya, Madagascar, Somalia and Ethiopia, between 20 and 50

times.

To establish a cut-price plantation, using village labour and land available free, costs at least R150 a hectare.

But generally the situation is not as simple as raising money, tough though that might be.

Villagers realised the need for plantations years ago, yet they did not get on with the job.

The difficulty lies with the pattern whereby a forester arrives in a remote village, exhorts the villagers to plant trees, then rushes away to the next village — a "top-down" approach, which takes little note of villagers' perceptions of their needs.

Far better is "social forestry" whereby the community plays a big part in the planning of the plantation from the beginning.

One successful initiative is the Kenya Energy Non-governmental Organisation (Kengo), a coalition of citizen activists who have decided to take tree-planting into their own hands.

The participants include women's clubs, church

groups, university departments, polytechnics and scouts and guides.

Kenya's forests have declined from about 5% of national territory in 1963 to 2½% today.

Representing large numbers of citizens, Kengo has planted more fuelwood trees in its first two years than the Government accomplished in the previous five years.

As a result, Kenya in 1985 should have more trees than it did in 1980.

Equally good news is that Kenyans are experimenting with new tree species for fuelwood plantations.

The US National Academy of Sciences reveals that over 1 200 tree species can qualify, 700 of them characterised as front-rank candidates. Of these, several score are available.

Curiously, certain native tree species can serve as "fertiliser factories".

Legume species, such as the acacias, take their own nitrogen from the atmosphere and transfer it to the soil, as well as to their own tissues.

In West Africa, trial plots of maize and cassava, interspersed with leguminous trees, produced at least one-fifth more food than had the maize and cassava been grown on their own, even though fewer stalks were planted per hectare.

Similarly, certain tree species produce their own insecticides, and when these trees are planted among crop plants, yields again increase.

If farmers could be encouraged to draw on natural sources of fertiliser and pesticides, they would reduce their needs for two expensive elements of Green Revolution agriculture.

A second aspect of the environmental story in Africa is good-quality water for domestic use.

The great health scourges of Africa, such as malaria, bilharzia and diarrhoea, are associated with contaminated water, or insufficient water. They strike particularly severely at children and high child mortality is a great barrier to family planning.

As long as black Africa does not have access to adequate water, it is unlikely to be able to tame its population growth.

Why isn't suitable water available to both urban and rural populations?

The immediate answer is that hydrological systems in Africa are being disrupted as watershed tree cover declines — which brings us back to forestry.

A less apparent answer is that governments have not yet accepted that investment in water is a front-rank development measure.

One pioneer is Malawi, a little-noticed nation with a public health record that draws praise from many observers.

The water pipes and stand taps in Malawi's villages accomplish more than the swankiest hospital in the nation's capital.

Regrettably, bilateral aid agencies prefer to support big gleaming hospitals rather than humbler stand taps.

Much remains to be done to improve the environmental picture in Africa, and the backlog expands each day. But if the outlook is less than hopeful, it is far better than hopeless.

If the positive examples cited were to be implemented across Africa, the situation could be massively improved in just a few years.

The remedies need not be expensive or based on high technology. Rather, they depend upon creative imagination and, as ever, political commitment by national leaders.

Regrettably, too many leaders see prestige in the shape of gun barrels rather than stand taps, in tanks rather than trees.

Ethiopia and Somalia are cases in point. The two nations have spent vast sums on arms — with encouragement from the super-powers.

If one-hundredth of the monies spent on armaments had been allocated to tree-planting, agriculture and the rest, the impulse to armed conflict would have been reduced, if not removed. — PEOPLE News/Features.

DURBAN, NOVEMBER 20, 1983

③ Sugar

Rorich sugar industry inquiry leaves

Finance Reporter

IT TOOK two years to gather evidence and prepare its report which was officially accepted and announced by the Government this week.

It was the Rorich Committee of Inquiry into the sugar industry which privately has been labelled by many sugar producers — growers and millers alike — as a waste of time and money. Peter Sale, general manager of the South African Sugar Association, told Tribune Finance, that the Government announce-

ment contained "so little that will have an immediate effect" on the sugar industry and virtually "everything that the industry sought has been deferred".

Basically, he said, nothing had been changed and the price of industrial sugar was still subject to Government control instead of the industry being allowed to determine it according to costs and the laws of supply and demand.

The association had submitted a number of alternative

methods of improving viability and profitability to the committee but had had to leave the final decision to the Government.

Only one point had emerged clearly from the Government announcement, made by Minister of Trade, Industry and Tourism Dr Dawie de Villiers, and that was that from the beginning of next season on May 1 growers would be responsible for the costs of transporting their cane to the mills, instead of those costs being shared by

millers and growers.

But even that is controversial for it means in effect that the more efficient growers will have to compensate for the transport costs of others before the final price of domestic sugar and the sucrose price are determined.

Since the major milling companies, such as Tongaat-Hulett, C G Smith and Transvaalse Suikerkorporasie, are also major cane growers and the new ruling is expected to have little or no real effect on

the sugar industry as a whole. About the only advantage to the private cane growers, said Mr Sale, would be that they would have greater freedom of choosing where they wanted to farm without first having to negotiate with millers on transport costs and the sharing of those costs.

"If a man finds a good farm with good soil and he is satisfied he had adequate water and he knows what his transport costs will be, he can then weigh up his total costs and decide

whether it can be viable," said Mr Sale. "It will be entirely up to him."

Cane transport costs, however, remained "a very complicated issue" and the Government pronouncement was not going to suit everybody.

Biggest disappointments to sugar men are the glaring gaps in the Government's final ruling.

What about the long-mooted development of the Makatini Flats to grow cane for conversion to alcohol as an alternative

fuel to petrol?

This would have provided jobs for thousands of blacks and eased tension stemming from widespread unemployment.

What about the production of alcohol fuels from any agricultural resource, sugar cane or casava, as a permanently renewable source of raw materials at a time when fossil fuels are diminishing?

Not a word.

What about assistance to farmers in KwaZulu to encourage them to grow sugar cane as

a source of cash income and another barrier against rampant poverty?

Not a word.

All that the Government has to say is that large scale expansion of the sugar industry anywhere has been deferred for two years, until 1985, when a decision, one way or the other, will be taken.

Taken by and large the Government ruling on the Rorich Committee recommendations has left the sweeter industry with a slightly sour taste.

SUGAR (3) *sugar* Lumpy prospects

The soaking rains now falling over the sugar belt have done little to brighten prospects for the embattled sugar industry.

On the local front, Minister of Industries, Commerce and Tourism Dawie de Villiers has refused a request to allow small, but frequent, price increases for industrial sugar to offset declining revenues from ex-



Financial Mail November 25 1983

*Am (3) ~~Wagner~~
28/11/83*

and there are doubts that a new agreement will be struck before then. In this event, most observers see the international sugar market developing into a free-for-all, characterised by widespread dumping and price-cutting, as happened in 1973-1978 when no ISA existed.

Some observers point out that SA came through the previous non-agreement period in good shape. One advantage is that it has a fairly limited exposure to the export market — about 1 Mt or about half its total production. Other countries, like Australia, sell nearly all their sugar on the international market.

Hardy says SA has built up a reputation as a reliable supplier of high quality sugar and that it should be able to retain its customers in the face of the anticipated heavy price cutting.

In the longer term, an international sugar war could only depress export earnings which will do nothing to ease the industry's critical debt burden.

Not surprisingly, the industry is working on a plan, which over time, will reduce its export dependency and concentrate more on the domestic market.

SUGAR - 1984

JANUARY - NOV.

By GERALD REILLY
Pretoria Bureau

CONSUMERS can brace themselves for a series of food price shocks in the first half of the year.

These include likely increases in the prices of dairy products, bread, sugar and maize.

This week the dairy committee of the Transvaal Agricultural Union met and, it is understood, will recommend to the National Dairy Committee of the SA Agricultural Union that an early meeting be arranged with the Minister of Agriculture, to demand a rise in the producer price of milk.

The national committee recommended a price rise last November, but this was rejected by the Dairy Board on the ground that there was a milk surplus and the time was not right for a price adjustment.

However the Minister gave the industry an assurance last year that from now on the milk price would be ad-

14/11/84

Big food price shocks on the way for SA

3) Sugar ~~SA~~

3) ~~SA~~

justed early in January.

The TAU's milk committee is expected to be strongly supported by the other provincial milk committees in its demand for an immediate price rise.

The consumer price of milk was increased last year by 7,5c/l. In July producers were granted a 3c/l increase and distributors 2,5c/l.

Then in November, distributors increased their margins by another 2c/l.

The bread price will also almost certainly be raised

long before the middle of the year.

Justification for a price increase is "overwhelming", according to Pretoria sources.

The issue is now with the Cabinet. It will either sanction an increase in the bread subsidy — which is considered highly unlikely — or a price rise.

An increase in the producer price of sugar is expected during the first quarter of the year. The general manager of the SA Sugar Association,

Mr Peter Sale, said application for an increase was submitted last year.

The last increase was granted a year ago. Since then, Mr Sale said, there had been big rises in costs in the industry.

A maize price rise is also certain in May. Producers were dissatisfied with last year's 9% increase.

And if maize rises, price increases for a whole series of foods will follow — meat, poultry, eggs and pork among them.

Jockeys



African jockeys, with their manager Mr Wally Colours. They are from left (standing) Gavin Michael Roberts and crouching, Felix Coetzee, Colours have been granted in recognition of an international jockey team in two tests to

Picture by ANTHONY McMILLAN

Price for owners

under 200 kg, has been raised from R5 to R20 although authorities point out it was still less than in other provinces where such fees ranged from R24 to R33.

A company using a truck with a weight of 3 600 kg will now have to find R275 in licence fees instead of last year's R220, while the flat-rate fee for caravans and trailers of R20 will be increased to R25.

Motorcyclists will have

Huge cut for Natal varsity

Mercury Reporter

A GOVERNMENT decision to slash subsidies will push the University of Natal into the red by more than R1 000 000 for the current financial year.

This was confirmed last night by the university's chief public relations officer, Mr Ray Carroll.

The university received a letter yesterday informing it of subsidy cuts to universities across the country totalling R10 m.

The spokesman said: 'Having raised our fees by 15 percent, which we con-

Sugar farmers face losses of R100 million

③ Sugar Mercury 10/2/84

Financial Editor

MEMBERS of the Umfolosi Sugar Co-operative face an estimated R100 m damage to fields and equipment and a four-year lapse before they can get any cash from their flood-devastated cane.

Mr Eric Buchanan, technical adviser for the South African Cane Growers' Association, just returned from the area, said the farmers needed financial help from the Government urgently.

'They are very despondent,' he said

'Twenty farmers, each with land worth R1 000 000, have lost their livelihood. Some 2 000 ha are buried under between 2 m and 3 m of sand.

'Other cane will rot and we think about 42 percent of the total crop has gone

'It will cost them R5 000 a hectare to clear if they do it themselves but a contractor would charge R10 000, which is more than the land is worth.'

They have lost 160 000 tons of cane worth R25 a ton. The loss for the whole area is about 420 000 tons — or about 45 000 tons of sugar.

Mr Buchanan estimated it would take between three and four years to clear the land of sand, turn over the fertile soil, plant new cane and wait for the crop.

Subsidies

Many of the farmers were still paying for 1977 flood damage and would be hit now by the loss of cane and diminished

profits from the co-operative mill.

The situation would prove a test of Government policy to keep farmers on the land and provide rural employment

He said the Government had paid out more than R12 m in subsidies and loans to southern Cape farmers flooded in 1981.

Some farmers might have to buy new farms and there was Government land available

The millions of tons of sand dumped on the land by the floods would be a problem to move and probably would have to be formed into dikes. If it were dumped in the river it could change the course and raise the level

At Pongola there was damage of R35 m caused by flooding through the

village and only parts of the farms were flooded as they were narrow strips going down to the river

Permits

About 600 ha were washed away and 1 000 ha were under sand. There would be a crop loss of about 160 000 tons

Pongola mill had 25 000 tons of sugar in storage which it cannot get to the local market because rail links were broken. Mr Glyn Taylor, managing director of C G Smith Sugar, said after a visit to the mill earlier this week

'We are going to arrange for road transport permits to move the sugar,' he said

Irrigation canals had been blocked and 8 km of tramlines used to take cut cane to the mill across five bridges had all been lost.

Raquel wins damages

London Bureau

FILM star Raquel Welch won large, undisclosed libel damages in the High Court here yesterday over nude pictures said to be of her which appeared in a girlie magazine.

The 43-year-old actress had been 'outraged and degraded' by the magazine as she had never posed for photographs in the nude, said her counsel, Mr Patrick Milmo.

He told Mr Justice Comyn that the three black and white nude pictures had appeared in Paul Raymond's Club International in February 1982 in a feature headed 'Raquel Welch bears all'.

NOW

England's
Luxury Cigarette

BACK IN TINS

RDM 1/3/84 (3)

Sugar^{Sugar} firms borrow R323m

Mail Correspondent

DURBAN. — The sugar industry will have borrowed R323-million by the end of this season, according to the latest industry estimates disclosed yesterday at the end of a two-day briefing of financial journalists by industry leaders.

It is a massive 72% increase on the amount borrowed, and outstanding, at the end of the last season in April 1983.

And with an anticipated gross income of R644-million for this season it will take a number of years before the loans can be repaid.

The interest bill this year is estimated at R28-million.

The precise level of borrowings will be determined by the Government.

They are expected to decide on increasing the price of sugar soon and the Government also must guarantee the loans raised with foreign bankers.

The Government, in taking this decision, will have to decide how much cash can be ploughed back into the industry which has been hard-pressed by drought, the recent floods and a low world price for sugar.

The industry has discussed the principles of a five-year plan, which could radically change the direction it is taking, with the Government and will be drawing up the details of a multiple pricing pool within the next few weeks.

Under this scheme farmers, and cane millers, would be presented with three different prices.

The industry has to supply the domestic market first and it will try and persuade the Government to lift the sugar price so that it will cover more of the industry's costs.

At present the domestic market carries about 55% of the fixed costs, which is low in comparison with many countries where the domestic sugar price is high but sugar is exported at a loss.

This would form the first pool.

The second pool would be governed by the export price but there would be guaranteed volumes to meet the needs of South Africa's traditional sugar importers.

The third pool would be paid for at whatever price the industry could sell the sugar for.

ATTENTION
TEACHERS AND INSTRUCTORS
HOW YOU CAN AFFORD
AN OVERHEAD PROJECTOR



AT
 Only
R299

IDEAL FOR SCHOOLS,
SEMINARS AND CONFERENCES

NEW OVERHEAD PROJECTOR
 retail price R379

- standing features:
- 30 degree projection angle
- overheating safety device
- transparency and roll format

cameraland
 FOR THE BEST PRICE AND PROFESSIONAL ADVICE

<p>THE TOWN Cameraland Long Street 4150 1/2 3/4</p>	<p>CLAREMONT Scala Cameraland Medical Centre Main Rd. Tel 61-7076</p>
<p>PAARI Westman Cameraland Grey Street (02211) 2-5555</p>	<p>BELLVILLE Mini-Kem Cameraland 187 Voortrekker Road Tel 97-0616 ext 7, 94-1606</p>

CLOSED SA1

C.T. 2/3/84
 Milk Producers Association
 yesterday which pointed
 out that the present in-
 crease would go into the
 pockets of the produc-
 ers alone — and that for
 the moment factories
 would absorb the infla-
 tion on their costs

The chairman of the Dairy Board, Mr Jan van Vuuren, said in a statement that the increase, approved by the Minister of Agriculture, was "essential to keep fresh milk producers in the industry in the Peninsula area".

The latest estimate had shown that there would be a surplus of only 1.35 percent in the area in 1984/85, while at least 10 percent was needed to ensure that producers could meet the daily need for fresh milk in the area.

Drought

Producers argue that because of daily fluctuations in fresh milk demand, a surplus has to be held to cover the demand on busy days.

The 10 percent sugar increase was attributed by the chairman of the South African Sugar Association, Mr Ian Smeaton, to the drought, which affected sugar production last year.

The drought had reduced sugar production by about 800 000 tons, he said. This had had a severe effect on the financial position of the industry, which would have to borrow a further R135-million to cover the expected costs of production in 1983/84.

Milk, sugar prices to rise

By MARTINE BARKER
CONSUMERS were struck a double blow yesterday with the announcements that the price of milk in the Peninsula will increase by 4 cents a litre next week and that from today sugar throughout the country is going up 6 cents a kilogram.

Both increases will be carried fully by the consumer.

The proposed increases, which follow the announcement earlier this week that train fares are to rise by between 7,5 percent and 17,5 percent, and the recent bread price increase of 6c a loaf, will hit the poor hardest.

Third-class commuter

train fares will increase by 12.8 percent, while first-class fares will go up by 9,1 percent.

Milk, sugar and bread are basic foods and the sugar price increase is expected to affect some canned foods, such as jams.

Milk, which presently costs 66c a litre if delivered at home, was last increased by 2c in December. The dairies' recommended price to retailers is 69c without GST.

A further increase in the price of milk seems likely in the near future in view of the statement from the Cape Dairy

 To page 2

bs on spies

At the outset, the five trainees lost the two "agents" and the "defector" while following them in Melbourne and had to ask the secret service base where they had gone.

They were told the targets were hiding in Room 004 of Melbourne's Sheraton Hotel. Its management had not been warned of the exercise.

The trainees booked into the hotel, spending three days in a room adjoining the agents before being told to move in for the rescue.

The trainees, already with party masks to their identities, asked for equipment, including handcuffs, three pistols, two sub-machineguns and a hammer.

The rescuers then made one dressed as a waiter (out party mask) and tried to persuade the agents to open the door to Room 004.

The group then smashed down the door with the hammer, to the con-

INSIDE

TV	2	Racing	7	Aircraft ..
Focus	8	Classified ..	15-22	Bridge ..
Weather ...	8	Comics	16	Burger ..
				Business ..
				Column ..

Sugar no longer so sweet down on the farm

By Duncan Collings, deputy Financial Editor

As far as the South African sugar industry is concerned the old adage that trouble always comes in threes, has certainly proved correct.

● First, there has been the weather. As if the disastrous drought which reduced the crop to 1,4 million tons last year was not enough, severe flooding this year brought on by two cyclones has lost the industry just over 3 000 hectares of prime growing land.

● Secondly, the low prices prevailing internationally and locally have resulted in the industry operating at a substantial loss for the past few years. This was aggravated by expensive import arrangements which were made last year as a result of the drought to enable the industry to meet its domestic and export obligations.

● Finally, while not yet a major problem as it only reduces the crop by one or two percent,

there is the Eldana Borer. A worm-type bug which is increasingly worrying the industry and which could have a major long-term affect on both the quality and size of the crop.

And there is little on the horizon to brighten the picture. Against the background of the government's anti-inflation programme any substantial upward adjustment in the domestic price — a key element of the proposed three-pool marketing arrangement designed to rescue the industry — has little hope of being accepted by the authorities.

On the international front, while the industry believes that the downturn in sugar prices has bottomed, there is little chance of any major upward movement while world stock remain as high as they are, as a result of overproduction.

Exports, once the saviour of the industry's financial situation

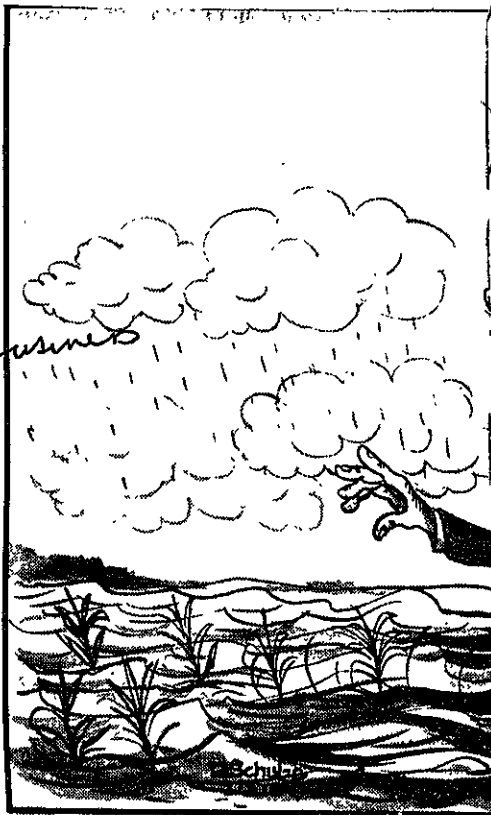

Mr Peter Sale, Sugar Association general manager

link for investors with PCs

By Malcolm Fothergill

A new service aimed at 8 African investors with portf worth R20 000 or more star Monday.

The service, which will a investors anywhere in the c try to tap in to the Olby in ment service's data via A American group company t puter Sciences, will be avai 24 hours a day, seven da week.

It will offer investors i stock market information comment through personal puters operating through Office modems or high-s terminals linked through phones.

Information packages wi

are now decidedly unprofitable and as part of its three-pool system, the industry proposes reducing its exposure to the foreign markets. But, as SA Sugar Association general manager, Mr Peter Sale explained, if South Africa were to withdraw from this market completely, it would find it extremely difficult to get back.

The idea therefore is to aim for a profit from local market operations, while retaining exports, albeit at a lower level and unprofitable for the foreseeable future.

The major problem on the international front is the fact that only roughly 18,5 million tons comprise the total free movement of exports world-wide out of total world production of around 100 million tons.

This small amount which comprises the world export market is theoretically controlled by the International

Sugar Agreement. But this is largely an ineffective agreement as the EEC countries have repeatedly refused to abide by it.

The current agreement — in terms of which South Africa may export 840 000 tons annually — runs out at the end of 1984 and there is little prospect of a new agreement being reached.

STOCKPILE

In this event the world sugar trade could be thrown into total disarray, worsening the already crisis-level situation. In this event South Africa would probably opt to stockpile its sugar until sanity returns.

The Eldana borer is also a seemingly unanswerable problem. Biological and insecticide methods of control have been conspicuous failures and while the experiment station of the industry at Mount Edgecombe in Natal is hopeful that in the longer term it will come up with an acceptable biological answer probably in the form of a parasitic ant — Eldana continues year-by-year to make inroads into the crop.

Overall only one to two percent of the total crop is lost annually as a result of Eldana, but in some areas the situation is far worse with up to 10 percent being lost.

So, what is the answer to the seemingly Catch 22 situations in which the industry finds itself?

This year that answer is to

borrow a further R135 million bringing the industry's total indebtedness to over R320 million but this must be strictly of a short-term nature.

PRICE RISE

In the longer term, if the industry is to survive — and it has reached that sort of proportion — the consumer and the government will have to accept that the local price must rise significantly.

Even with the 10 percent increase granted yesterday to the industry, South African sugar remains one of the cheapest in the world.

But even here the industry is in a cleft stick. If the local price rises too much, the maize industry may be tempted to start producing high fructose corn syrup — a sugar replacement displaying all the qualities of cane sugar without the stigma of being a chemical substitute.

In the US high fructose corn syrup has already made significant inroads into the sugar market because of the high price of US sugar. The industry would certainly not like to see this situation developing in South Africa.

Whatever the solution, and answer ensuring the long-term financial security of the industry must now be found, a very narrow path will have to be followed.

3 Sugar
Slow Business
3/3/84

the Professionals. UXTC
tributes of a Professional
ork. 2 (3) July 1987
Professional Land Area
chemical Engineers' B
OVT Printer.

~~3~~ (3) Sugar Star 2/3/84

Dearer sugar will hit cold drinks, sweets, canned fruits

Pretoria Correspondent

The 10 percent rise in the price of sugar is only one of a series of price increases consumers can expect, says the Consumer Council.

In a statement in Pretoria, the council's director, Mr Jan Cronje, said that the higher sugar price would inevitably cause many other products to go up in price.

But, for the moment, the three biggest supermarket chains — Chequers, OK Bazaars and Pick 'n Pay — will stick to the present price of sugar.

Prices of cool drinks, sweets, chocolates and canned foods will be pushed up as a result of the increase.

Spokesmen for leading manufacturers and retailers said the increase was likely to heighten a swing from the use of sugar to alternative sweeteners and from canned foods to fresh produce.

But the biggest impact probably would be on canned fruits, already suffering from consumer resistance, they said.

Spokesmen for the cool drink and sweet industries said their prices would be affected but they could not yet say by how much.

Higher sugar prices are reported to have decided the Coca

Sour news for sweet teeth

Cola group to increase its usage of high fructose corn syrup from 50 to 75 percent of its sweetener content.

Mr A N Zulman, managing director of Beacon Sweets, said that, for the sweet industry, there was no suitable alternative to sugar and he expected that sweet prices would go up.

But the increase in the sugar price — by R48 a ton for white and R43 a ton for brown — will not substantially ease pressure on the sugar industry.

Even after this increase the industry will still be producing sugar at below the cost of production.

It sells about half its annual

production on the home market and has an obligation to satisfy its local customers first. The balance is exported.

But there is a world surplus of sugar and, due to the switch to artificial sweeteners and the activities of the anti-sugar lobby, there are no immediate prospects of supply and demand coming into balance.

Nor is there any chance of this position being offset at home as the price is controlled.

The result is that the industry was R188 million in the red after the 1982/83 season and its total debt this season, which ends this month, will be R323 million.

SA sugar price lift loses despite

By Barry Sergeant

SOUTH Africa produces sugar more cheaply than nearly any other country — and yet the SA housewife pays more for her sugar than her counterpart in most countries.

SA consumers will give the industry what amounts to a subsidy of more than R300-million this year because of the low sugar price in London. The SA Sugar Association says the London price is depressed by dumping.

Dr Frans Oosthuizen, Sasa national market and communications manager, says: "Despite inflation above that of our trading partners, our price of R510 a ton is well below that of our major trading partners. Producer prices this week were R867 in the US; R703 in England; R673 in Germany; and R555 in Australia."

The 10% price increase takes the cost of a ton of white sugar to R510. The free-market sugar price in London this week was less than R250 a ton.

Ian Smeaton, chairman of the South African Sugar Association, says: "The new prices are less than the cost of production. Control of wholesale and retail prices was abolished in November 1983."

Shoppers will pay about 6c a kilogram more for sugar, depending on where they live.

After transport costs and profits by wholesalers and retailers, the effective price of packets of sugar is nearly R700 a ton in Johannesburg.

Threat

The new price threatens South Africa's R600-million a year sweet and chocolate business. Imported confectionery can be landed below SA product costs.

Mr G E Craig, chairman of the South African Sweet and Chocolate Manufacturers Association, says: "Although imports are only about 5% of consumption at present, exporters from overseas can buy raw materials such as milk powder and sugar at well below the South African price."

The soft-drink industry, the biggest user of sugar in SA, will have no choice but to pass the increased price on to consumers. Coca-Cola says:

"There will be price rises, but not for some time."

If SA consumers could buy on the world market, the annual needs of 1,2-million tons would cost about R300-million. Instead, the bill will be more than R600-million.

Dr Kees van der Pol, vice-chairman of Sasa, says: "No country in the world can produce a ton of sugar at the London price. There are producer nations which will sell at any price to earn foreign exchange."

The 10% increase, which is in line with inflation, compares with the 7,5% on February 25 last year, about half of the then inflation rate.

Buttressed

The general manager of Sasa, Peter Sale, says: "Although the industry will be buttressed by the increase in the producer price, it will have accumulated a record debt of R323-million by the end of the 1983-84 season."

Dr Oosthuizen says: "The industry can produce 2,2-million tons in a normal season. Last year's drought caused the loss of 800 000 tons."

"Although this season's estimated crop of 1,4-million tons will satisfy SA demand, the tonnage lost represents R195-million computed on the lunatic world price."

Since 1961, the sugar industry has used probably the most sophisticated financing found in any agricultural commodity. The industry price of R510 a ton is negotiated with the Government.

It is based on the cost of growing and milling cane, including an allowed return on capital. About 40% of this price goes to the millers, the rest to the growers. The traditional crop easily satisfies SA demand and the rest is exported.

Growers and millers take their fixed cut from domestic sales and whatever they can get from exports. Any surplus between their take and the overall income goes into a tax-neutral stabilisation fund; a deficit is financed by loans.

Sasa export manager David Hardy says: "But in the past nine seasons, the industry has made surpluses only twice — 1974 and 1981."

Mr Sale says: "The industry lost about R200-million between 1972 and 1976. The world price was high, and Government's pricing policy resulted in the consumer price being around half the world price."

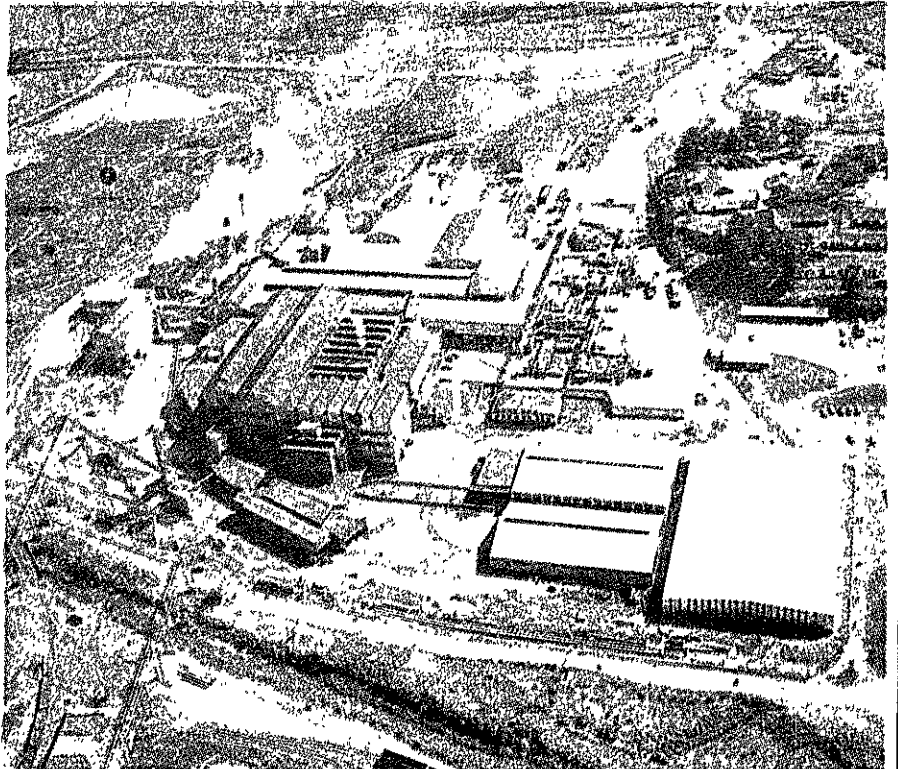

C G Smith Sugar's Gledhow mill near Stanger — embattled by drought and a dumped world sugar price

Raw 8/3/84

E. Sugar

Low rise in world sugar consumption forecast

By SIMON WILLSON

DESPITE possible global economic recovery, the Australian sugar industry predicts world sugar consumption will grow by only about 1.6% in 1983-84 to 95.6-million tons.

But a cyclical recovery in the falling world sugar price is expected as international sugar stocks are depleted.

The Queensland Cane Growers' annual report says the main retarding influence on any parallel recovery in world sugar consumption is the extreme balance of payments pressures on many developing nations.

"Without recovery of consumption in the highly populous Third World, any significant improvement in sugar absorption is unlikely.

"In developed countries, consumption will continue to fall because of stable or falling per capita consumption and the effect of sweetener substitutes.

"High-fructose corn syrup and other alternative sweeteners as well as sugar are now facing competition from aspartame, a new low-calorie sweetener."

India has generated a gross domestic oversupply because mills have been forced to pay high prices for cane. Farmers have therefore been growing cane in preference to other crops.

Supply and demand in world sugar are expected to be in balance in the 1983-84 season, chiefly because of a late improvement in the European crop. But world stocks of about 38-million tons make net supply much greater.

The Queensland growers say two major factors are limiting any movement back to balance of sup-

ply and demand:

● Market distortions brought about by the EEC support arrangements for sugar, and

● Debt crises facing many countries whose consumption is vital to any take-off in world sugar consumption.

"On the other hand, forward estimates cannot include natural disasters, and twice in the last five years world production has been reduced by more than 4m tons through weather-related crop problems.

"Experience suggests that such problems can change the market outlook from surpluses to shortage almost overnight."

Production in 1984-85 is likely to rise following the return to more normal climatic conditions in the world's major sugar-growing areas, but this will not reduce significantly the large world sugar stocks overhanging the market.

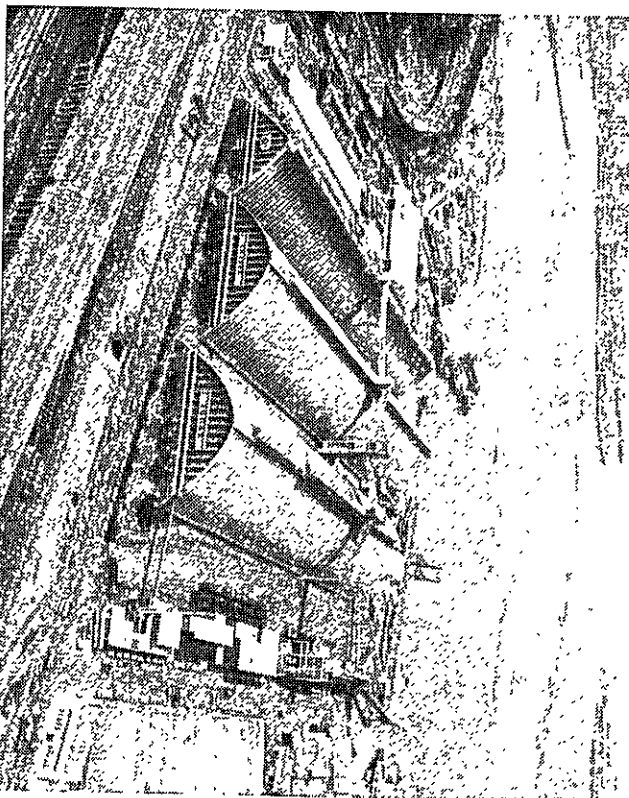

The South African sugar industry predicts a free-for-all among world sugar producers if, as expected, efforts to negotiate a new International Sugar Agreement end in deadlock this year. Local cane growers and millers have indicated that they will not put South African sugar on the world market in such a free-for-all as the price would be driven down as exporters fought for markets. Domestic production will, instead, be stored in the South African Sugar Association's dockside silos pictured above at Maydon Wharf, Durban. The three existing silos can store 520 000 tons of sugar, and this capacity can be expanded. Plans for a fourth silo have been drawn up and would cost about R30m. The extra silo would be to the left of the three pictured above.

Deadlock

in sugar

industry

wage

talks

By Carolyn Dempster,
Labour Reporter

Official wage negotiations covering some 11 000 workers in the sugar industry reached deadlock in Durban this week after unions rejected the final offer made by employers.

The deadlock came after weeks of negotiations and after a private meeting between two major sugar employers and unions had failed.

The new Industrial Council agreement was due to be implemented on April 1.

In a statement released yesterday, Mr Barry Horlock, vice-chairman of the employers' association, said in view of the fast-approaching April pay day, employers had decided to implement their final offer despite the deadlock.

"Within the next 48 hours employees throughout the mills will be advised of this decision," he said.

OFFER

The offer amounts to an increase in minimum wages of 10 per cent, and not less than eight per cent on current rates; the introduction of a washing allowance; the introduction of weekly, fortnightly or monthly pay to be negotiated at each mill only for members of the National Union of Sugar Manufacturing, Refining and Allied Employees; and recognition of June 1 as a public holiday this year.

Mr Horlock said he hoped the move would maintain industrial peace, but it was not without risks as the industry could not operate indefinitely without an agreement.

The unions have called for another meeting under the auspices of the Industrial Council on April 27.

Facing up to the crunch

Sugar

All that is sugar is not sweet, as many a farmer from Natal will tell you. In fact, despite rains and a normal crop this year, the sugar industry is in for some rather bitter pills in the months ahead. Not least among them is a growing — although perhaps belated — recognition of the need to reassess its own cost efficiency.

Like all enterprises that have their destinies rooted in the soil, some of the problems sugar men face are beyond their immediate control. Typical are the drought, softening export markets and the rising cost of farm inputs.

But the sugar industry's problems could be more intractable than those, for in-

The tough economic truth is at last getting through to the sugar industry. Good rains, a normal crop and easily available loans are not sufficient to pull it out of trouble. It will have to look also to its own backyard.

stance, of the maize industry. Good rain over the Magaliesberg at the height of the growing season could rapidly restore vigour to SA's maize crop. Instead of importing maize and burdening the Treasury, SA would then be in a position to earn valuable

foreign exchange from maize exports, as it did before drought gripped the subcontinent.

The same, unfortunately, cannot be said for sugar. Good rains over the cane belt this season, while boosting crop expectations, have done little to improve prospects for the debt-ridden industry.

After two successive droughts and a sustained period of low world sugar prices, the industry has an accumulated debt of R323m. And with world prices hovering around £115/t and little immediate prospect of a price rally, the future looks decidedly bleak — even though, for the first time in a while, the industry is headed for a crop

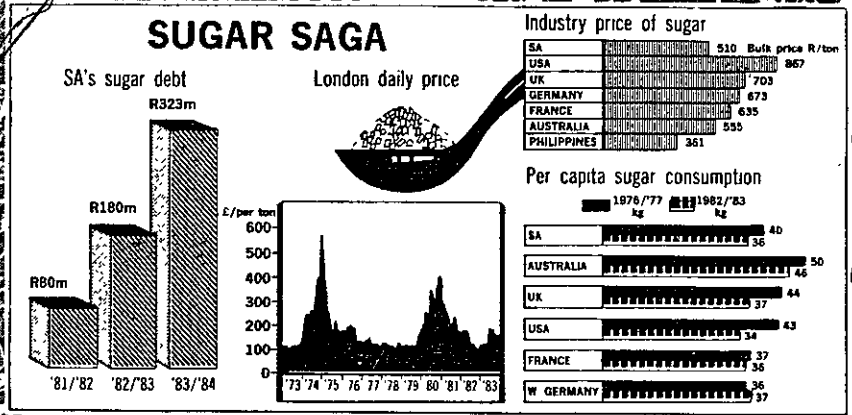
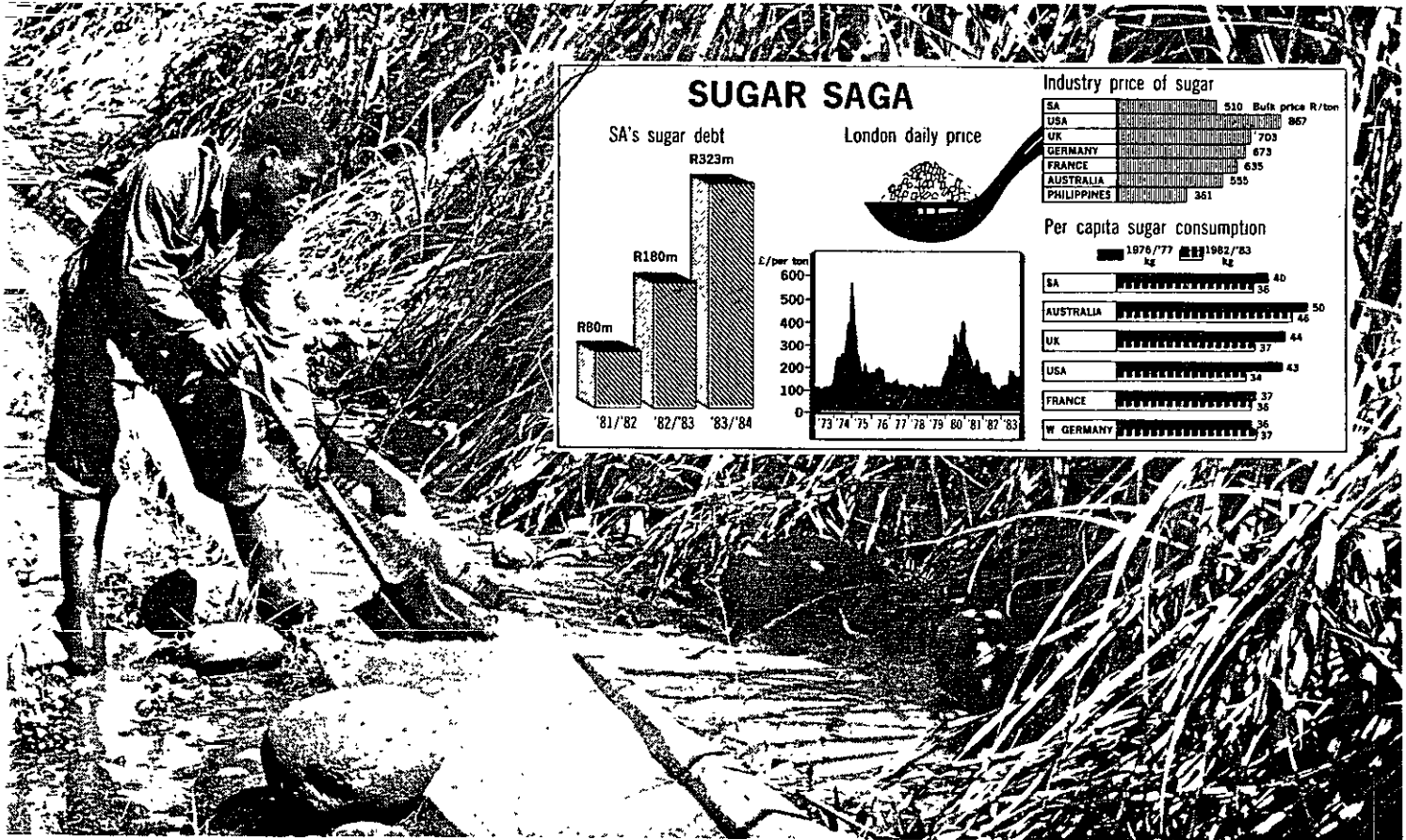

W.A. Taylor (3) 12/14/84

of normal proportions

Says Glyn Taylor, MD of Smith Sugar: "Even though there has been great cane recovery, the current season is not expected to make any contribution to the industry's loan position. In fact, the way things are stacking, we will probably be looking for further price support." In sugar parlance, "price support" is a euphemism for loan finance.

The size of the industry's debt is now of major concern to both growers and millers. It has grown from a modest surplus in the 1980-81 season to R80m in the 1981-82 season, R180m in the 1982-83 season and R323m in the 1983-84 season. At its current level, it is costing the industry around R45m/year in interest charges alone.

Sugar men, including Taylor, now openly talk of their disquiet. There is much debate over whether it would be desirable for the industry as a whole to extend its borrowings.

That further loans can be obtained, there is no doubt. Peter Sale, GM of the South African Sugar Association (SASA), says loans for the previous season's full shortfall of R135m have already been secured in the Eurodollar market. The debt crisis in Central and South America and elsewhere has encouraged bankers to seek SA business, which is much less risky. Loans to the sugar industry are government-backed and government has assisted by being prompt in supplying the necessary guarantees.

SASA officials lament that the industry would not be in such a parlous position if it were not for the low world prices. At £115/t, prices go nowhere near covering what the industry calculates are the costs of production. Even the higher local price of R510/t (there was a 10% price increase in February) does not cover full costs, including growers' and millers' allowable returns on capital. Worst of all, they are committed to selling about 1 Mt sugar/year on the export market at the currently depressed prices. Low export earnings, while making some contribution to the industry's fixed costs, add little to revenue, which has to be buffered principally by local market sales.

Ten-year cycle

Some may argue that one solution could be to withdraw from the export market. But that appears to be easier said than done. As SASA's Sale points out, sugar has a 10-year crop cycle, which means that customers who are unprofitable now may indeed be just the opposite at a different stage in the cycle. So the retention of market share can be important. In addition, SASA is committed to long-term supply contracts.

The optimists tend to point to the cyclical nature of the sugar industry and venture that, given time, all will come right. True, in the mid-Seventies, the world sugar price was around £600/t and the healthy surpluses built up in the



Raising cane ... the costs will have to be met

stabilisation fund did go towards wiping out previous deficits.

But what the industry may stumble over, or neglect to react to, is that there has been a fundamental structural change in the world sugar market since the heady days of high world prices. Huge stocks of around 30 Mt — about 40% of annual consumption — now overhang the world market; consumption, at least in the industrialised societies, is declining; and artificial sweeteners are gaining an increasing share of the sweetener market.

In short, exposed as it is to the slump in the international market and not being in a position to increase its borrowings indefinitely, the industry, in the words of one grower, is "caught between a rock and a hard place."

A new International Sugar Agreement, with the regulatory effect it would have on world sugar stocks and production, would partly ease the pressure. But talks in London and Geneva have failed to yield anything positive. If there is to be a new agreement, it will have to be struck before the current one runs out at the end of the year. But the need for sugar exporters to retain their markets in the face of the heavy subsidies enjoyed by producers in the EEC and US have put them in no mood for compromise.

Given the circumstances, SASA's export manager, David Hardy, is not hopeful that a new agreement will be forthcoming. And

if one does emerge out of panic as the deadline approaches, he frets that it may do the local industry more harm than good. He says: "There are such big mountains to climb, it is difficult to imagine where they will come out."

In the absence of any sound alternatives, an inescapable conclusion is at last beginning to dawn: a shake-out of the higher-cost producers and the more inefficient farmers is inevitable. No longer can the industry keep on borrowing to cover its costs of production. At some point or other, the piper will have to be paid. Nor can it expect the local market to pick up a bigger share of its costs. Domestic sugar prices are already about as high as they can reasonably go.

Bearing transport costs

In some respects, the Rorich Commission report and the changes it proposed for the cane transport system, as well the industry's experimentation with multiple pools, is an attempt to face up to the problem. The new transport scheme is expected to "flush out" higher-cost producers by making growers bear the burden of transport costs. The hope is that land far from mills will eventually go out of cane production. Multiple pools, with price support for a portion of the export market only (the balance being uncovered), will eventually allow growers to determine their own exposure to the international market. The consensus, however, is that both are long-term palliatives. Still more immediate corrective action is needed.

According to sugar industry sources, there are several options. The industry can increase its borrowings — something which it is clearly reluctant to do in the light of its already heavy debt. It could look to the local market to cover a bigger proportion of its costs — at the risk of price resistance and opening the door to alternative sweeteners. Government could be approached for a direct handout — something which would probably invite tighter government controls. It could renege on its export commitments or it could borrow only a minimal amount, say the difference between the local market price and its costs of production — on the understanding that growers and millers would have to cover any shortfall themselves.

"The feeling now," says one industry spokesman, "is that if proceeds do not cover costs of production, then growers should be allowed to go to the wall."

If that happens, it will herald not only a move away from the feather-bedding and a return to more free-market principles, but also pretty tough appraisal of what is regarded as costs. That, in itself, can only be good for an industry that has a legacy of overprotection. And if the weak and inefficient have to suffer in the process, that must be seen as an acceptable price to pay for restoring the vitality of the industry and reducing the domestic costs of a staple food over the longer term.

Ruined farmers slam

Umfoloji disaster could have been avoided, they say

THE heartbreaking devastation of 2 500 hectares of prime land in the Umfolozi Flood Plain need never have happened.

Farmers in the area, many of whose land is now irreparably damaged, have blamed the agricultural conditions and bad management in the Umfolozi catchment area for their predicament.

And officials of the Umfolozi Co-operative Sugar Planters' Limited agree.

Said farmer and chairman of the co-op, Derek Heaton-Nicholls: "If there had been correct conservation and storage facilities, like a dam in the catchment area, we would still have had flooding but not to the extent it occurred."



Stories by JO TYLER

"We would still have our land — probably one of the most arable regions in the country — intact if there had been better management in the catchment area," members of the Umfolozi Sugar Farmers' Association said.

"Bad farming methods and lack of storage facilities in that area contributed to the devastation. The sand that was washed down came from the catchment area. It

was not here before and would not be here now had there been better planning.

"We want to emphasise this point because as a co-op and a farming association we have been pushing for a dam to be built in the catchment area for at least 15 years.

"We realised something like this could happen. We paid consulting engineers and hydrologists out of our own pockets to draw up plans and reports for this.

"These experts assured us that had there been a dam, the devastation would not have occurred. The sand would not have been carried down and our land would still be productive and one of the best in the country," the farmers said.

A dam would have cost about R30 million.

The farmers said that when they had submitted the experts' reports to the authorities, ecologists had slammed the suggestion for a dam because they felt the natural riverine vegetation would be lost.

"But during the flooding this vegetation was lost anyway. And far more was lost — the best land in the country.

"A dam in that area would not have benefited only us farmers. It would have provided irrigation in KwaZulu as well as here and it would have helped in the transportation of fresh water down to St Lucia and in the Richards Bay complex."

During the flooding, the volume of water at Umfolozi was estimated about 20 000 cubic metres a second. "Our experts estimated a dam would have reduced the amount of water by about a fifth," the farmers said.

"If the authorities still refuse to build a dam there is a potential hazard that flooding will occur again and more land in the flood plain could be irreparably damaged."

The farmers said people had questioned why they had settled in the delta area in the first place. "World-wide the best arable land is found in delta areas. Civilisation actually began around delta areas. There would have been no risk to us had there been better planning in the catchment area," the farmers said.



□ Peter Hitchens surveys the devastated land. All that is left are the tops of the

Cane farmers face uncertain future

DESPONDENT Umfolozi sugar cane farmers, who are grateful to the Government for rescuing them financially, are still uncertain about their future.

There's a chance some of them will be able to get nearby State land and a chance to start again. And they say they're not too frightened to do so.

But there's also a chance that some of them will have to abandon farming and look for jobs in the cities.

Twenty-six farms in the Umfolozi Flood Plain were devastated and irreparably damaged when Cyclone Demoina brought rain and flooding to the once fertile region.

Now the area looks like a desert.

This week Minister of Environmental Affairs, Sarel Haywood, estimated the rescue operation of the devastated 2 500 hectares, 1 935 hectares of which were irreparably damaged, could cost about R25 million.

The money would be used to buy the land from the farmers at pre-cyclone market prices. And the farmers would, as far as possible, be encouraged to continue farming on State-owned land made available by the Government.

But after waiting four months for an announcement by the Government, the farmers are hardly better off. Only a limited amount of State land is available and farmers fear that some of them may have to leave the area and buy land elsewhere, or worse, forget about farming and move to the cities.

"If we had wanted to live and work in the cities, we would have sold up long ago. As it is most of us have lived in the area for years, some of us have been here for generations. Farming is in our blood," members of the Umfolozi Sugar Farmers' Association said.

"Although we are very grateful to the Government for the money, we are still despondent about our futures.

"First we don't know

how much money each of us will receive. We don't know how much suitable State land will be available. And we don't know how many of us will have to sell up and move to another farming area, or maybe to the cities to find work.

"This indecision is very unsettling. And the Government announcement, although it has helped us financially, has not made decisions any easier for us," the farmers agreed.

"We can't help feeling a little bitter about what has happened. Everything we worked for has been destroyed. There are small stretches on some of the 26 farms that could still be farmed but it is not viable for any of us to keep the farms going for these.

The Government announced farmers would be encouraged to consolidate these small stretches of healthy farmland. "But we don't feel this is really a viable proposition because the land is in a very vulnerable position.

"For four months we have been living with indecision. Most of us have kept all our labourers on. Some of the indunas have been on the farms for 40 years or more. We felt it would be unfair to kick them out just like that.

"Obviously we would like to continue farming, especially in the area; we have all worked towards building up the Umfolozi Co-operative Sugar Planters Ltd. But at this stage none of us can say what will happen."

About six weeks ago several other farmers in the area who suffered extensive, but not irreparable, damage to their property — involving about 7 500 hectares — were given State aid to help them recover.

Other aid, announced this week, included a subsidy of R430 000 for the private sugar mill of CG Smith.

Meanwhile the Umfolozi co-op will receive a maximum of 75 percent of the costs of repairing drainage systems from the Department of Agriculture and a 75 percent subsidy from the Department of Environment for repairing damage on river banks.

The co-op had also been advised to apply for a loan from the Land Bank to repair its transport system — it will receive a 30 percent loan on the subsidy from the Government.

Money can't buy what we've lost, says farmer's wife

"NO money can buy what we have lost. I still can't believe it when I look out the window — instead of beautiful lush sugar cane, I just see sand ... mounds and mounds of white sand. It's heartbreaking," said Cherie Morkel, as she described her once flourishing Umfolozi Flats farm.

"When the wind blows, you can't keep the sand out. There's sand everywhere, in everything. I never believed this could happen."

Cherie and husband Ralph have been on their land for 20 years. They've survived bad crops, floods and drought.

And then Cyclone Demoina struck.

Demoina brought the worst flood in memory and what was once the best sugar cane land in Natal was transformed in a dry and dusty sand bowl.

The Morkels own one of 26 farms, totalling about 2 500 hectares, all of which were devastated and irreparably damaged by the floods.

All of the farmers in this area, some of whom have been here for generations, have lost their livelihood. It is unlikely that sugar cane will be grown on their farms again — at least not for many years.

An ecological study has shown at least 1 935 hectares of the estimated 2 500 has been irreparably damaged. The study suggests the land should be taken over by the Directorate of Forestry.

In place of rich fertile soil most of the land is now covered in two metres of fine sand, in some places the sand is four metres deep.

"The Government has been very generous but no money can buy back what we had. We have been living with indecision since the floods and the Government money hasn't changed that.

"At least we will be paid a reasonable price for the land — although none of the farmers know exactly how much each is getting — but if we cannot find other suitable land in the area we will have to leave everything we have worked for.

"The thought of starting from scratch is horrifying," Mrs Morkel said, looking at the beautiful farmhouse that was a tiny brick building when they moved to the area.

None of the farmhouses in the area were damaged by the floods because they are on higher ground, although many of the farmworkers who do not live as high up, lost their belongings and their homes were either destroyed or badly damaged.

"Together the farmers need 2 500 hectares of suitable cane land. If that cannot be found, some of us will have to move. Some of us may even have to go to the cities. I just don't know what will happen," Mrs Morkel said.

"When the floods came I don't think anyone expected the devastation that occurred. While it was happening, I knew it was bad but I didn't realise how bad.

"Finally the water subsided and I saw the sand. It was terrible. And then the wind blew and everything was covered by clouds of fine dust. It still happens.

"It has effected the men the most. As farmers they are used to waking up at 5am and they still do that out of habit. But instead of going out to tend to the lands, they just lie back and look at the four walls.

"The indecision is terrible. We just don't have any idea at this stage what we are going to do."

authorities

'Average sugar farmer owes 30pc of his farm value'

Financial Editor

THE average sugar farmer now owes 30 percent of the value of his farm, despite the fact that the sugar industry has obtained R327m in loans, Mr Lawrence Gordon-Hughes, chairman of the S A Cane Growers' Association, said at the annual meeting in the city yesterday.

Farmers who live in sugar producer in the drought-stricken areas owe even more and 'further losses during the coming season will aggravate the already precarious financial position of a large number of our members.'

Turning to the crop forecast he said it was ironic that after the drought there should be floods, followed by good rains: the estimate was that the 1984/5 season would produce a record crop of 19,8m tons of cane. This beat the previous record in 1981/2 of 19,6m tons.

The interest burden over the last five years has risen from R1,35 per ton of cane to R3,21 cents and net farm incomes have declined from R2,50 to R1,18 cents a ton.

'After paying interest the average grower was incurring a farming loss of R2 per ton of cane during the past season.'

He said the industry was planning to restructure to allow cane farmers to make up their own minds on production and determine their profits.

Instead of the industrial headquarters deciding on production and then being forced to sell on often below-cost export markets, the decision would be in the hands of farmers.

Two pools

The scheme would provide two pools.

Pool A would allow a cane price of say R30 a ton and the amount of cane each farmer could provide would be related to the best three years of production in the past seven.

Pool B, aimed at supplying the export market — would have a price of, for example, R12 a ton, but in the years when the export price was high this pool price would be high too.

'The thrust of the present planning in the industry is towards a more marketed-orientated industry with less control by Government and a simplification of the rules and regulations of the sugar industry agreement.'

Mr Gordon-Hughes said that a recent survey had shown that South Africa was the second cheapest

But the sucrose price was only R177 a ton — against R245 in the previous season — and relief could only be sought from domestic consumers, the State or the industry.

At times export profits had been used to

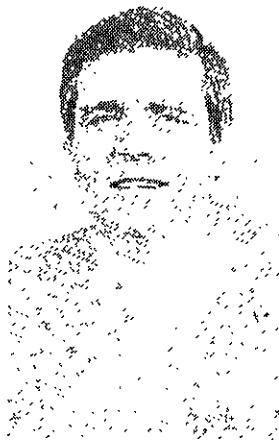

Mr L Gordon-Hughes

subsidise the domestic market and as a result the loss of revenue at current prices was about R550m. 'Now the tables are turned and the industry requires urgent assistance from local market consumers.'

He pointed out that other agricultural activities had enjoyed substantial help from the Government in various fields which the sugar industry had never had.

The sugar industry was an effective 'decentralisation of industry' activity as well as providing income and jobs in activities related to the industry.

Sugar exports provided much needed foreign exchange for the balance of payments.

Call for the small grower to be protected

Financial Editor

SMALL sugar cane farmers could not be allowed to go the way Mr Tony Ardington, vice-chairman of the S A Cane Growers' Association, said at the annual meeting yesterday.

He said that sugar cane agriculture in KwaZulu represented the largest and most successful small holder development on tribally-held land in Southern Africa.

'A setback of this nature would not only be a catastrophe to the many thousands of individuals concerned, but also a major reversal in the rural development prospects of these areas based on agriculture. It must not be allowed to occur.'

Mr Ardington said that full extent of the tragedy, facing the industry, could not be appreciated unless the farmers who could not get commercial finance and whose 'very livelihood depends on the income that flows from their cane production' was examined.

There were thousands of small cane growers and they made up a significant part of the industry.

'At current prices they have no hope of generating a surplus for their own consumption needs. In order to exist it will be necessary for these people to run down their investment in cane.'

'This will leave them with a continuing debt but with no means of paying it off.'

Discussing the prospects of an international sugar agreement (now being negotiated in Geneva) he said that all the ingredients for negotiation were in place — great economic hardship, possible economic ruin for some producers, and no optimists or bulls left in the market place together with a desperate desire to reach a political solution where the economic solution had failed.

Mr Ardington believed that the prospects for an improvement in prices in 1986 were good.

Sugar industry to be restructured

Own Correspondent

DURBAN. — The average sugar farmer now owes 30 percent of the value of his farm, in spite of the fact that the sugar industry has obtained R327m in loans, the chairman of the SA Cane Growers's Association, Mr Lawrence Gordon-Hughes, said at the annual meeting yesterday.

Farmers who live in drought-stricken areas owe even more and "further losses in the coming season will aggravate the already precarious financial position of a large number of our members".

The interest burden over the last five years has risen from R1,35 a ton of cane to R3,21 and net farm incomes have declined from R2,50 to R1,18 a ton.

Farming loss

"After paying interest, the average grower was incurring a farming loss of R2 a ton of cane in the past season."

He said that the industry was planning to restructure to allow cane farmers to make up their own minds on production and determine their profits.

Instead of the industrial headquarters de-

cidng on production and then being forced to sell on often below-cost export markets, the decision would be in the hands of farmers.

The scheme would provide two pools.

Pool A would allow a cane price of say R30 a ton and the amount of cane each farmer could provide would be related to the best three years of production in the past seven.

Pool B, aimed at supplying the export market — would have a price of, for example, R12 a ton, but in the years when the export price was high this pool price would be high too.

Planning

"The thrust of the present planning in the industry is towards a more marketed orientated industry with less control by government and a simplification of the rules and regulations of the sugar industry agreement."

Mr Gordon-Hughes said that a recent survey had shown that South Africa was the second cheapest sugar producer in the world.

Turning to the crop forecast, he said it was ironic that after the drought there should be floods, followed by good

rains. The estimate was that the 1984/85 season would produce a record crop of 19,8m tons of cane — this beat the previous record in 1981/82 of 19,6m tons.

But the sucrose price was only R177 a ton — against R245 in the previous season — and relief could only be sought from domestic consumers, the State or the industry.

Export profits

At times export profits had been used to subsidize the domestic market and as a result the loss of revenue at current prices was about R550m.

"Now the tables are turned and the industry requires urgent assistance from local market consumers."

He pointed out that other agricultural activities had enjoyed substantial help from the government in various fields which the sugar industry had never had.

The sugar industry was an effective "decentralization of industry" activity as well as providing income and jobs in activities related to the industry.

Sugar exports provided much needed foreign exchange for the balance of payments.

Sugar industry must weigh up free

enterprise

By MIKE PEIRSON,
Finance Editor

SHORTCOMINGS in the Government's marketing of its new policy on free enterprise were highlighted this week by the managing director of the Tongaat Hulett group, Dr Geoff Cleasby, when he spoke to the Sugar Technologists Association in Durban.

"It is a fact that much of South Africa's industrialisation over the past 25 to 30 years has taken place behind protective barriers of tariffs and import controls," said Dr Cleasby. "These have shielded our infant industries from the winds of international competition. Also much of our industrialisation has involved State or para-

State organisations.

"Unfortunately the sugar industry, whether we like it or not, falls into both these categories of its new policy on free enterprise. Complete protection and this week by the managing director of the Tongaat Hulett group, Dr Geoff Cleasby, when he spoke to the Sugar Technologists Association in Durban.

"It is important to note that the Government's new economic policies emanate chiefly from the recommendations contained in the Kleu Report on the Steenkamp Commission Report on the textile industry; and these new policies will, I understand, be embodied in a White Paper at the end of the year.

"It is encouraging that a broadly based committee has been formed that is representative of both the Government and the private sector to consider the implementation of the new policy.

"But it is regrettable it will deal only with the application of the new industrial protection policy and not the basic principles of adopting a free enterprise system and the free trade approach to the economy.

"With any free enterprise system it is clear that there must come a time when the infant industry argument can no longer be used to justify what amounts to a subsidy by local consumers of the local producer.

"The consequences of this change to a free enterprise policy can be extremely serious for certain industries although sound theoretical reasons are advanced in its support — such as the need to control inflation so we can remain in exports for manufactured goods and export our way out of unemployment.

While it was true, Dr Cleasby explained, that commerce and industry were continually faced with price increases from State or para-State services and industrial organisations.

The problem of inflation had to be tackled but what was not so clear was whether the "carrot" of increased export incentives for industry would not be more effective in achieving this objective than the "stick" of withdrawing protection and import controls too quickly, as the Steenkamp Report appeared to be recommending for the textile industry.

This was a real dilemma and to find a balance between the carrot and the stick would need a good deal of fine-tuning by the Government and the private sector over a long time if the new policy was to be effective and not harmful.

Higher productivity was a top priority, too, and could be achieved only through more enlightened and competent management, vastly expanded skills training and a considerable improvement in black education. But this came at a time, unfortunately, when the Government did not have the money.

Dr Cleasby surmised, however, "There is no doubt we will emerge from our recession (possibly much later in 1985 than is widely predicted at present) and our economy will grow again at real rates which will be envied by most industrialised countries.

"It is possible, however, that we will not see again the boom times of the late Seventies and early Eighties, at any rate not for some time to come. This is because the economic recoveries in the US and Western Europe are still fairly fragile and certainly have not yet resulted in an upsurge in demand for our basic raw materials.

"The economic future is, therefore, like a jigsaw puzzle in pieces and the challenge for the future is to make sure Government and private sector fit the pieces together in the correct way."

He said, while the country could not afford double digit inflation, jobs had to be provided for better educated future generations with greater expectations than ever before.

"We want the free enterprise ethic but we dare not dismantle the protection and controls in a way which, in the short term, will add to the problem of unemployment both in industry and agriculture.

"We would like to decentralise our industry but at the same time we have to cope with and find a solution to the ever-increasing urbanisation around our cities."

How the new free enterprise policy would be applied was difficult to predict but there could be a pragmatic and flexible, even inconsistent, interpretation because the direction of the policy was not quite clear.

It was important the sugar industry appreciated the importance of the change in policy and how it would be affected. To ignore it would be fatal.

"Just as the Rorich Commission's recent recommendations on cane transport were implemented when millers and growers could not agree on what was best for the industry, the new economic policy could be forced on the industry unless it decides what it wants and has the determination to go in that direction," Dr Cleasby said.

Sugar seeks major industry overhaul

(3) Sugar 1/7/84

THE sugar industry may introduce a multiple pool system at the beginning of the 1985-86 season.

This was announced by Lawrence Gordon Hughes, chairman of the SA Cane Growers Association, at its annual meeting.

Drought, fixed prices and a poor export market have forced a re-examination of the industry's fundamentals.

Drought cut 800 000 tons from the normal crop of 2,2-million tons this season, and the resulting 1,4-million tons is only enough for domestic demand. It is the smallest crop since 1965.

R139-m loan

Mr Gordon Hughes said about 170 000 tons of sugar was imported to meet domestic refined-sugar requirements, and exports were reduced to 230 000 tons. The revenue forgone by the industry was an estimated R200-million measured on the average world price.

To meet production cost requirements, a loan of R139-million was raised, increas-

By Barry Sergeant

ing the industry's debt to R327-million. Loan sources were SA and foreign banks under facilities guaranteed by the SA Government.

Growers and millers are paid after annual R40-million interest costs.

Real fall

The cost to the industry of the 1983-84 drought was R400-million measured on exports lost. The domestic price rise in March 1984 was not enough to obviate raising the new loans.

Mr Gordon Hughes said that since 1970, the real cost of sugar to the consumer had fallen from 75c to 63c a kilogram.

Analysing the past five seasons, he said that had loans not been resorted to, the average grower's income would have fallen by R75 000. In 1983-84 alone, without a loan, the average grower's income would have been reduced by R42 000.

In spite of the additional revenue, the average indebtedness of growers had increased to 30% of farm value — worse than in many other sectors of the farming community.

Although a survey had shown SA to be the second-lowest cost sugar producer in the world, the Government had allowed loans instead of prices to increase.

Mix

The Government's move to a freer market had to be assessed by the industry against its inter-related mix of agriculture, industry and international quota obligations. As a result of the Kleu report, the Government had fixed the sugar price with reference to market forces rather than by reference to production costs only.

The present pricing formula for domestic sugar needed

overhauling. When introduced in the early 1970s, it was understood that more responsibility would be given to the industry in setting prices. However, even after the Rorich Commission report, this had not been implemented. sectors of the farming community.

Multiple

He said: "It is obvious that the Government no longer accepts the present formula, so much so that price increases granted by the Government have consistently been below the general price increases in the economy."

The two unrelated markets — the domestic where prices and demand were stable and the export where prices were volatile and an oversupply existed — had to be faced by producers.

Instead of having a pool price, there should be a price for each market. If there were a multiple pool system, the producer would have to reduce production for the second pool if world prices dictated it.

Incentive

"At present a reduction in output reduces income by the average cane price and, during periods of low world prices, incorrectly provides an incentive to maintain production in certain marginal areas. Conversely, during periods when export prices are higher than domestic prices, current arrangements would not correctly reward those who increased production for that market."

A multiple pool system would correctly structure incentives and would not transfer the risk of producing for the export market from those who chose it to the rest of the industry.

Sugar farmers' bitter harvest

20/7/84

3 Sugar

S few



Sugar leaves a bitter taste in my mouth lately.

I have just returned from looking at the rampant development along Natal's South Coast — at the request of local people who invited me down because they fear that property firms (mainly from Transvaal) are wrecking their coast.

More about that next week. Quite apart from coastal development, I was struck by what is going on beyond the mental stockade which whites have erected against the "black hills" of the interior.

The great patches of kwaZulu are still spectacularly beautiful and not anywhere near as ravaged by bad farming as I had imagined.

This says a lot for the Zulu women (who do all the farming), because the sugar industry has grabbed the best land and left kwaZulu only with land too steep for cane.

And so the people grow their crops on narrow terraces cut into gradients which would test a sherpa.

Watching women, babies on their backs, carrying huge 50 kg head-

boards of firewood up from the valleys many kilometres below the treeless canefields, ecologist Dr T C Robertson of Scottburgh commented:

"The State should strike a medal for the women of kwaZulu".

Right now the sugar price is high and labour costs low. "When that happy situation ends one must pray hard that mealies don't replace cane," Dr Robertson said.

He pointed out that row crops like mealies would lead to enormous and rapid soil erosion.

Sugar, because it grows densely, at least protects the soil.

It is difficult working up a love for Natal's sugar farmers. In so many valleys I saw cane planted, quite illegally, in river courses.

They know perfectly well the risks. In the 1960s, conservationists warned Natal farmers that planting within the flood lines would damage the land.

The Government ignored the problem. Came this year's floods in northern Natal and the

cane and the soil was swept away for ever. Farms lower down were smothered in silt.

The naked valleys increased the velocity of the floodwaters and thus the Umfolosi Valley was devastated.

Farmers made fortunes while the soil held. Now they want the taxpayer to compensate them! We should be suing them.

Indeed, the police should be chasing them around those ruined hills like the common felons they are.

Mercury 26/7/84 (3) Sugar

Business
Mercury

Sugar industry must be rescued, says chairman

Financial Editor

THE SUGAR industry must be 'rescued' because it is a cornerstone of the entire economy of Natal Mr Ian Smeaton, chairman of the S A Sugar Association, said at the annual meeting yesterday.

The highest density of rural black people was found in Natal, KwaZulu and Transkei and 'poverty in these rural areas poses a continual threat of massive immigration to the cities, with the attendant problem of squatting and inadequate facilities.'



Mr Ian Smeaton

The sugar industry had a vital role in stabilising the rural population — some 20 000 black farmers were involved in the sugar industry and farmers and millers employ, directly, 150 000 workers who support 750 000 dependants.

Additionally, Natal has one of the highest unemployment rates in the country. Without the sugar industry the economy of Natal would shrink dramatically.

'Many ancillary activities such as transport, engineering, general commerce and industry would collapse, with a further adverse effect on the labour market.'

'Fat cat'

Mr Smeaton said he had heard that the industry had a 'fat cat image' and was therefore not considered to be in need of assistance.

'I would have thought that the "powers that be" would investigate our po-

sition rather than act on an assumed idea.'

While the industry's founding fathers had 'established the industry and created an image of wellbeing — perhaps even affluence — the 1980s had been disastrous' with drought (in 1983/4 it was the worst in living memory) and low world prices.

'I would point out that this industry has had no drought assistance other than Land Bank loans to certain farmers. This industry is deserving of better treatment by Government.'

Mr Smeaton said the sugar industry should continue to export, provided that in the long term it was economic and 'is of benefit to the country as a generator of foreign exchange.'

It should be borne in mind that the Government was always encouraging exports and provided incentives — but not to the sugar industry.

Mr Smeaton said that the industry was working on a multiple-pool system to be introduced from next season (May 1985)

Outline

The main outline of it was being discussed with the Government and consisted of two pools.

The first would meet the needs of domestic consumers and half the sugar needed for export contracts. This would be paid for at a 'reasonable remuneration to the producer under normal circumstances.'

There would be some price stabilisation in this pool, which would have a minimum level of remuneration. Below this, loans would be raised; above, the surplus would be diverted to a reserve fund.

The second pool would deal with the balance of production — about half the exports.

There would be price support in this pool, which would be

voluntary, and 'producers who elect to participate will have to accept whatever proceeds are realised on the export market for their production, whether this be high or low.'

'The onus will be placed on each individual grower or miller to decide whether his particular cost structure permits him to economically participate in the second pool.'

Quota

Mr Smeaton pointed out that the application of this system could see high-cost producers reducing their production to the first pool level, which would operate on a quota system.

'This could lead to a stronger and more viable industry overall as weaker elements reduce production.'

A vital component of the pool system would be the price and the industry 'must be remunerated on a fair basis for sugar sold on the domestic market.'

~~SECRET~~ Fm 27/7/84

by the demand for gas oil (diesel) rather than petrol. Output of the latter, boosted by local synfuel production, is considerably in excess of gas oil. Even in the present recessionary phase, there is little to suggest that demand for diesel has flagged.

Longer pump trading hours and easier speed limits suggest the authorities have motorgas to burn; the severe speed clamp (80 km/h) on 9 000 kg vehicles suggests there is a fine balance between demand and supply of gas oil.

With SA coastal refineries operating at less than 60% of capacity, owing to factors such as the recession and increased Sasol synfuel output (which gets preferential market treatment), current levels of crude imports must be substantially reduced. On the other hand, procurement agencies are having to pay for their oil with a rand that is

teetering around \$0.65. The balance between the two factors is delicate, but it cannot be quantified, because of official secretiveness.

Nevertheless, there should be a good case to be made out for holding fuel prices a while longer by dipping into the strategic stockpile. Energy Minister Danie Steyn has proclaimed that it has been done before. It should be done again. The trouble with oil price increases is that they push up production costs. With SA's generously accommodative money supply policy, this abets our inflationary psychosis, something we could do without right now. The country needs a little price stability.

If that can be achieved by borrowing from the stockpile, the lion's share of which was assembled at less than \$3/barrel, then government should do it.

THE SUGAR PRICE

The consumer's premium

③ Sugar Fm 27/7/84

When a sugar baron is quoted in the press saying that export prices are so low government will be asked to increase local prices, it suggests he believes the country owes him a living.

His colleagues maintain he was quoted out of context. Nonetheless, they cannot deny that, over the last five years, SA produced so much sugar that nearly half had to be sold on volatile world markets, with this year's exports going at less than half local prices.

Neither can they deny that SA could import raw sugar at about R200/t as against the local price of about R460/t.

Whatever the context of the sugar baron's remarks, it is clear that without a high local price, producers would have no incentive to grow so much and then to have to dump the surpluses on world markets.

Under the present system, sugar mills guarantee to buy, at an agreed price, all the cane farmers can deliver. It is thus not surprising there has been over-production even when demand has been slack and even during the last drought. One shudders to think of what would happen to the economy if our mining and manufacturing sectors were run by the same rules.

Another reason why the industry consistently produces more than local needs is its hope of making a killing on world markets should prices move up — as they sometimes do.

But why should consumers help carry sugar's business risks? If the industry did strike it rich overseas there is

scant chance it would share the bounty with others.

Government and the industry are now drafting a "multiple pool" system. Growers will be issued quotas calculated to cover local demand, for which they will receive guaranteed prices, with excess production being bought at world prices.

Industry sources admit this would limit production and help keep down local prices. But it would also increase bureaucracy and opportunities for corruption in the trafficking of quotas.

A simpler method of containing prices, short of removing all controls and protective mechanisms — a measure few governments would risk — is to freeze the local controlled sugar price.

The latest price increase is being requested on the grounds that escalating costs have brought the industry's average return on investment below levels allowed by government and to "prevent bankruptcies."

If these are the only reasons the industry can come up with, the authorities should have no compunction in turning down its request. Government has shown a growing disenchantment with the idea of rigging prices to guarantee profits — as the newly-rationalised fertiliser industry already knows. Why should it not apply the same thinking to sugar?

The threat of bankruptcy has been known to spur competitiveness in other sectors of the economy — so why not in sugar?

US POLITICS

In the face of prosperity

In present circumstances it is difficult to see the Mondale-Ferraro ticket as anything but a losing one. The choice of a woman as the Democrats' Vice-Presidential candidate — intended to draw off support for Ronald Reagan in one area in which he is perceived as vulnerable — is likely to be little more than an historical footnote to a campaign in which the state of the US economy will be the real debating point.

As the strength of the dollar testifies, the US economy is growing at a pace unprecedented in two decades. Whatever other Western nations may feel about the side-effects of this burst of prosperity, voters have a sense of well-being which, rightly or wrongly, will translate into support for Reagan at the polls.

Sexist it may not be; but the Democrats' choice looks to be the wrong team at the wrong time.

Does cane wreck the land? The debate continues as . . .

Sugar men fight back

James Clarke, recently back from looking at environment problems on the South Coast, suggested sugar farming was damaging. The sugar men invited him back, saying: "Let US show you around . . ."

I stood on the Spanish-style balcony watching a yellow sun rise over the Indian Ocean. There were dolphins leaping in the polished waves just beyond the rocks they call Umhlanga.

I was about to face the sugar farmers. They were upset. In my column a week previously I accused them of flouting soil conservation laws and wrecking the land. I suggested the police should be chasing them round their hills for the common felons they were.

My tangle stemmed from a recent visit to the South Coast where Dr T C Robertson and others had shown me how the industry "has cost us the almost complete destruction the coastal forest". Said Dr Robertson: "All we have left are the riverine forests and lagoons — now even these are threatened."

I do not think, even now — even after enjoying the excellent hospitality of the sugar farmers — that he was exaggerating. Not as far as the South Coast is concerned.

"I am prepared to debate the proposition", said Dr Robertson, "that the sugar industry has no economic necessity in South Africa."

He feels the South

Coast is not good sugar country and, in any event, "why use scarce cropland to grow carbohydrates when it's protein Africa needs?"

From Umhlanga I found myself whisked 100 km north to Mandini to meet sugar farmer Tony Ardington — a charismatic ex-Michaelhouse boy who was a Rhodes Scholar and read at Oxford. He runs an immaculate 300 ha farm of his own and helps run a long-established 400 ha family farm nearby.

He is on numerous committees, civic and provincial, from Durban to Ulundi. He is involved with the sugar industry (chairman of the SA Cane Growers' Association *et al*); with regional development (the Buthelezi Commission for instance) and is a committed conservationist (black conservation education in particular) with a knowledge of birds bordering on the expert.

He is definitely not the sort of fellow I would put the police on to.

He showed me his own carefully contoured farm — a model of conservation farming.

When I later suggested to the Sugar Association that it had shown me the best farm in Natal — that it was a bit like pre-tending Buckingham Palace was a typical London house — it assured me there were better. I wondered, but have since found there is an annual award for the best conserved cane farm in Zululand and Tony Ardington, who enters every year, has never won it.

"White" Natal, along the North Coast, is just about two farms wide. Its rolling canelands have a lush and uniform texture, the farmsteads are well-spaced and prosperous — and I saw no erosion. On the kwaZulu side there are also extensive canefields but the texture is not as smooth, reflecting the differing skills among kwaZulu's 18 000 black growers. But there is still an air of prosperity.

I had remarked in my column that along the South Coast, where the land becomes too steep

for cane, it has been given to kwaZulu. On the North Coast this is certainly not so.

Tony Ardington was not convinced that the juxtaposition of the canefields and black farms of the South Coast was a result of white chauvinism. It was, he said, more because of historical happenstance. The canefields were planted along the railway line and that happened to be where the gentler slopes were. The blacks got what was left.

Both Mr Ardington and the Sugar Association's researchers felt strongly that sugar was a legitimate contributor to national well-being — economically, ecologically and from a health aspect.

They conceded that not all cane growers are saints. They admitted that some do plough to river banks, risking wash-aways in a flash flood.

But, curiously, this is not illegal. Not according to the association's legal men. The Soil Conservation Act is certainly fuzzy on the point. And, apparently, before a prosecution can be made there must be "visible evidence" of damage. Hardly a preventive law.

After the Domoina floods earlier this year, more than 2 000 ha of sugar land were buried so deep in silt that they have been written off. The Umfolosi valley — the worst-hit area — was devastated, its ancient sycamore fig trees washed out to sea. Was this the fault of careless sugar farmers upstream who had left their lands vulnerable to erosion?

"Yes," say several conservationists. Critics include people such as Ian Garland — highly respected by the sugar industry and, indeed, quite generously funded by them.

"No," says Tony Ardington. "There are no sugar cane farmers upstream on the Umfolosi. That silt came from far upstream — way beyond sugar farms."

Professional ecologist Bruce Liggitt pointed out some time ago that sugar men had drained swamp-



When the Umfolosi River of Northern Natal came down in flood during February, large areas of canelands were ruined by being covered with silt.

land to plant cane, reducing the swamps' "shock-absorber" effect on floods.

This led to sugar farms, near the estuaries, being smothered in silt from sugar farms higher up. In the time available I was unable to settle this matter but it is being investigated by Professor John Hanks of the Institute for Natural Resources in Maritzburg.

Bruce Liggitt suggests that canefields in the former swamplands be bought by the State and the land returned to its natural state.

On the other hand, argued Tony Ardington, "is it really as bad as it is made out? Throughout history man has planted the flood plains."

True, but South Africa has no flood plains. A swamp is certainly not a flood plain. A flood plain is an extensive piece of flat land which is inundated from time to time and enriched by nutrients carried from up-river.

Conservationists have argued that sugar farmers frequently break open sandbars at the mouths of estuaries so river levels are kept low and they can grow cane almost into the river beds.

The sugar industry is vigorous in defending its economic importance —

even if it is currently facing massive losses because of successive droughts.

Mr Ardington pointed out that, unlike maize or cattle farming, sugar farming is labour intensive, and that is vital for Natal. He told me how the industry is trying to make rural work as attractive as possible. But it is not easy.

A top class cane-cutter can earn around R10 a day — plus free housing and other perks. But, given half a chance, he would still rather work in a factory at a lower wage.

What really makes the sugar farmer angry is that in 1974 when sugar was fetching around R1 000 a ton (about 20 times, in real terms, what it fetches now), the Government took the advantage and reduced the price of sugar on the domestic market, thus robbing the farmers of a very fat profit that year.

On the question of whether the lands should be used for protein or carbohydrates: several slopes are nowadays planted to pasture. I saw some fat cattle grazing on the Ardington family farm. "What are those?" I asked. I meant what breed.

"Protein," said my host.

(3) Sugar
Star
30/8/84

Govt raises wholesale price of sugar 12,5%

14/9/84 (2/4) (3) Sugar C. Times

Own Correspondent
JOHANNESBURG. — The government has taken a brave, but unpopular step for the consumer, of lifting the wholesale price of sugar by 12,5 percent from today, more important, it has given the go-ahead for the industry to embark on a pool system which could protect it from low export prices.

White sugar will now cost R573,75 a ton — up from the 10 percent increase in March which took the price to R510 — and brown sugar slightly less.

But the price hike has only brought the price to the farmer and miller to the break-even level.

They will still have to shoulder export losses and the constantly rising costs of farming and milling inputs should push the industry into a "loss" position in six months.

Financial risk

Full details of the pool system are still to be announced but it appears that each farmer will decide whether he wishes to produce for export and he will carry the financial risk.

The industry will not have to carry the financial burden of exports and will, most likely, act

as an agent using its established export channels.

The Minister of Industries and Commerce, Dr Dawie de Villiers, said the financial problems faced by the industry were "now reaching distressing proportions".

This had been caused by the droughts and the low international sugar price.

While the "yearly increase" of 10,4 percent in the wholesale price had been allowed in March, the industry had borrowed R327m, partially to bridge the yearly deficits.

"The present high interest rate results in an interest burden of R47m a year."

Deficits

"Further deficits could compel the industry to increase the loans, which could cause permanent damage.

"The government has considered various alternative forms of assistance but decided that a further price increase in these circumstances was unavoidable.

"It has agreed to an increase which would possibly prevent a number of growers from discontinuing their farming activities.

Dr De Villiers noted that the government and the industry were engaged in restructuring the industry to make it more cost-efficient.

Because sugar cane had a cycle of between eight and 10 years, "changes could not be affected overnight".

From this year onwards a new cane transport system was in operation which could to a large extent assist in placing the industry on a sound economic footing.

"As from the 1985/6 season (May 1, 1985) the industry will introduce a pool system. Further particulars will be made available later."

Dr De Villiers said these steps would lead to a rationalization of the industry and to considerable cost savings.

Consumption

"It should be emphasized that the application for a price increase by the industry was not made lightly.

"It is realized that the two large price increases have a detrimental effect on consumption, in addition to the danger that alternative sweeteners could possibly affect the consumption of sugar."

The chairman of the SA Sugar Association,

Mr Ian Smeaton, reacted to the increase by saying: "We appreciate the fact that the government has recognized the serious financial plight of the industry and taken steps to provide a partial solution to the problem.

Production costs

"Domestic sugar has been selling at below the level of production costs and this increase will do no more than bring the consumer price closer to the correct level at which it should have been set at the beginning of the season.

"At this new level, the domestic consumer would not be providing any financial support of the sugar industry's export operations.

Regarding the production pool system which would be introduced from May 1, 1985, he said its terms were that the decision to produce for the export market and the financial consequences of that decision would be carried by individual growers and millers rather than remaining with the industry as a whole.



CG Smith's Sezela sugar mill among best in the world

By Stan Kennedy

The current season will see the C G Smith Sugar group producing close on 900 000 tons of sugar, with 245 000 tons coming from Sezela, where a R55 million expansion programme to increase production by 25 per cent has just been completed.

In 1980, the Sezela mill — one of six in the C G Smith food division — was crushing at 360 t/hr. To cope with an expected crop of 2 300 000 tons of cane in 1987/88, crushing capacity had to be increased to 450 t/hr.

As a result, the mill is the largest in South Africa and among the top five in the West.

It is in third position on sugar recoveries of the 17 mills in the industry, which also means that, technologically, it is among the best in the world.

A fifth phase of the programme would raise crushing capacity to 500 t/hr, but this will only be done if extra cane supplies warrant it, Mr Glyn Taylor, managing director of Smith Sugar, said during a media tour of the mill this week.

Sezela operates a company, Inkanyezi, to develop cane land for black growers in Kwazulu. This is where the extra supplies could come from, once they become more proficient and can produce higher yields.

There are 2 100 growers, with 4 800 ha of developed cane land, capable of producing 150 000 tons of cane a year.

Smith Sugar produces about 40 per cent of South Africa's sugar production of 2 300 000 tons a year, which is about the

same tonnage as the Tongaat-Hulett Group.

The rest is made up by six independent mills.

The mill is capable of crushing 2 300 000 tons of cane and producing 250 000 tons of sugar a year.

Technology and automation to increase efficiency and productivity and reduce operating costs has made the mill almost self-sufficient.

The mill produces its own steam and electricity, and it obtains much of its water requirements from the cane itself.

Bagasse, after being processed at Smithchem, adjacent to the mill, for the extraction of furfural and furfuryl solvents is returned to the mill where it is used as fuel for the boiler.

Expansion at the chemical plant, which cost R32 million over the past three years, has made it the second largest producer of furfural products in the world. Exports of the products have climbed from R4,5 million a year to R20 million a year.

The plant produces 16 000 tons of furfural and 12 000 tons of furfuryl alcohol, of which 90 per cent is exported. Main markets are the United States, Japan and Europe.

Furfural is used in the purification and manufacture of lubricating oils, and furfuryl alcohol is the major ingredient of resins used in the foundry industry.

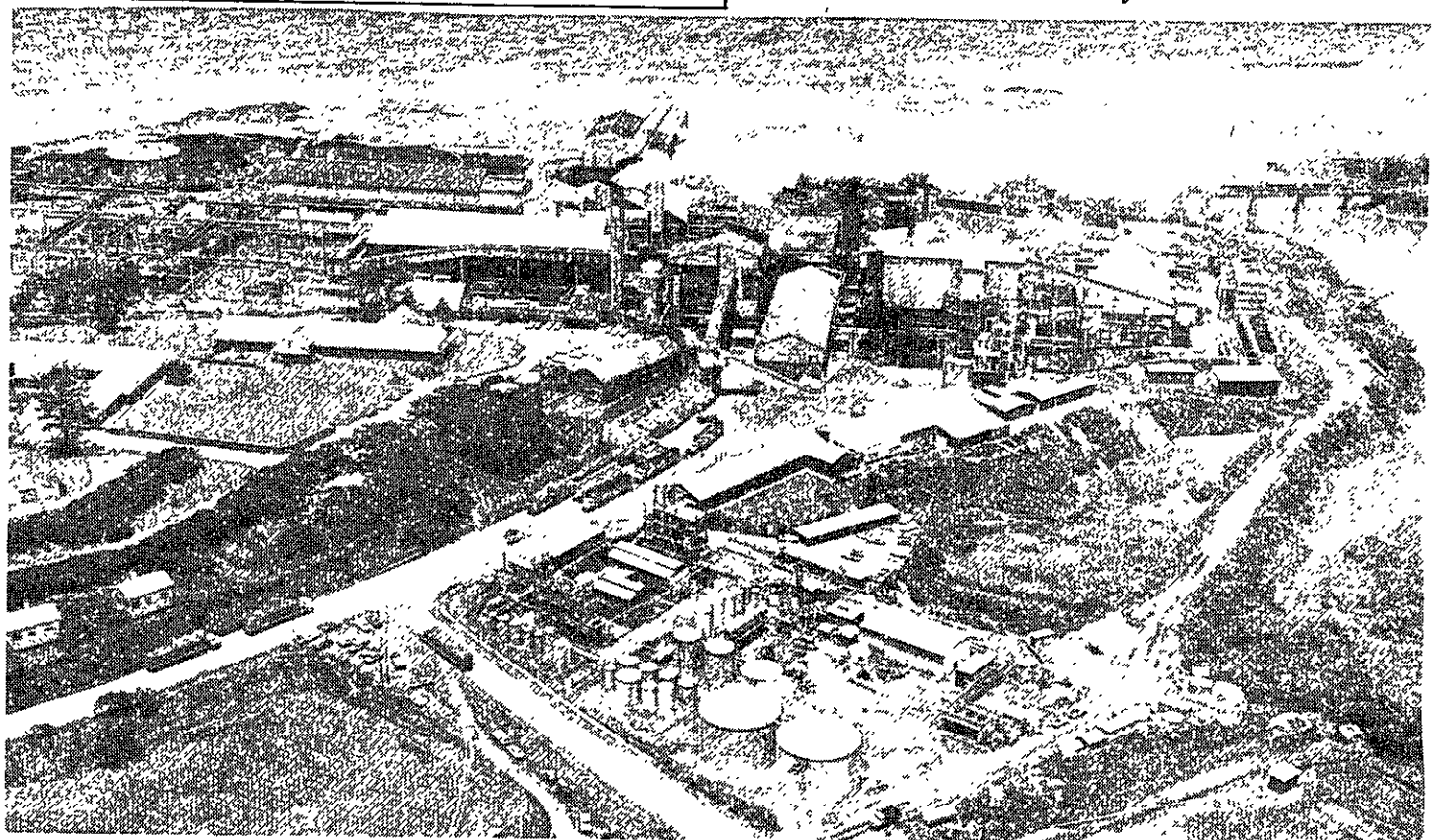

C G Smith Sugar's Sezela mill, south of Durban, with the Smithchem plant in the foreground.

Mercury 20/11/84 (3) Sugar (4) (55)

Sixteen North Coast families in fear of the future

Sugar workers to lose their jobs, housing

SIXTEEN families in company housing on a sugar estate at Doringkop near Stanger have been given notice to vacate it by the end of December. Their breadwinners have been retrenched by the giant Tongaat-Hulett group.

Some of them have been living in company quarters for more than 30 years and were among the original workers at Doringkop while the local mill was under the control of its former owners, the Illovo Sugar Company.

Their services were retained after the mill was taken over by the Ton-

Labour Reporter

gaat-Hulett group.

They are desperately worried about their future.

Mr Thumba Naidoo, a former turbine driver with the company, told the Mercury: 'Working and living at Doringkop has become a way of life

for most of us.

'Most of the retrenched workers are above 50 years of age and finding suitable alternative employment at this stage in our life is going to be very difficult.'

Mr Naidoo, 54, a father of five, said the workers had been given three months' notice of their retrenchment at the end of September and had been told to vacate their company houses by the end of next month.

Meanwhile an air of uncertainty hangs over the small Doringkop valley housing the workers and their families near the lifeless sugar depot.

Tongaat-Hulett group public relations spokesman Ron Phillips said yesterday that the workers had been retrenched after the shut-down of the tramway system of transporting cane — a common sight on sugar estates in the early days.

He said the workers had been given 'very favourable' retrenchment benefits and the company was doing everything possible to help them find alternative accommodation.

'We'll probably allow them to continue staying there at a nominal rental if the houses are not required immediately



Mr B Naidoo and Mr Y N Naidoo in front of the families of the end of ne

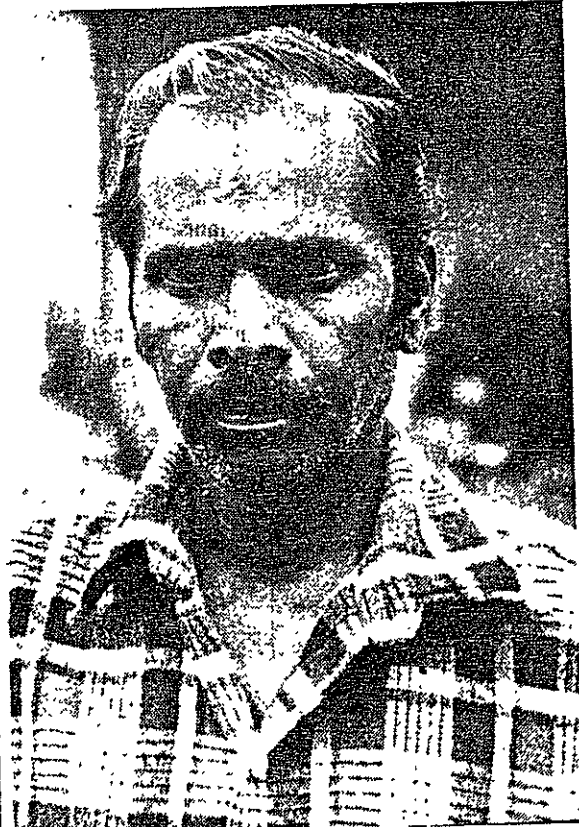

Mr Thumba Naidoo, who was among those retrenched at Doringkop.

SUGAR —

AGRICULTURE — SUGAR

1985

TO - METAL CONTAINERS AND ALLIED PRODUCTS INDUSTRY, CERTAIN

AREAS.

Superceding w.d. nos: 320 & 408

AREA A: Municipal Areas: East London and Harrismith

AREA B: Bellville, The Cape, Goodwood, Paarl, Port Elizabeth, Simonstown, Uitenhage, Wynberg, Durban, Inanda, Pinetown, Sasolburg, Alberton, Benoni, Boksburg, Brakpan, Delmas, Germiston, Johannesburg, Kempton Park, Klerksdorp, Krugersdorp, Nigel, Oberholzer, Pretoria, Randburg, Randfontein, Roodepoort, Springs, Vanderbijlpark, Vereeniging, Westonaria and Wonderboom

Footnotes

1. Overtime hours - The maximum hours overtime per week in factories manufacturing metal containers or allied products used in canning of perishable raw materials is 20.

Zulu canegrowers flourishing

Financial Reporter

THE Financial Aid Fund established in 1973 by the sugar industry to stimulate rural development of sugarcane growing by Zulu, Indian and Coloured small cane farmers has increased cash incomes for growers from R2,7m in 1974 to R25m in 1981 and this could be as high as R42m by the end of the present decade.

During that period sugarcane production, with the financial and technical help of the fund, has increased from 405 827 tons to 1 227 366 tons.

Since the inception of the fund the scheme has provided loans totalling more than R20,9m to Indian, Zulu and Coloured small canegrowers.

Glendale Sugar Mill has been particularly well-served by the scheme, with 46 percent of the mill's total crushing last season being supplied by Zulu growers financed by the fund and the Kwazulu Development Corporation.

Zulu farming in the rugged scenic Glendale valley, 15 kms inland of Stanger, dates back to the 1950's, although it is highly probable the 'domesticated few' downed their tools of war for the hoe and farmed alongside their white immigrant counterparts as far back as 1880, when the boldest of the early settlers established farms in the area at Glendale Heights.

Red banks

However, records show that it was only in the early 50's that the Zulu farmer began to extract some of the wealth from the fertile red banks that cradle the snaking Mvoti River through the 9 km long valley.

Today the cane-lined Glendale hills contribute a more meaningful way of life to the many black families that have improved their way of life considerably through the fund.

The maximum loan offered by FAF to growers is R1 402 per hectare and is only available to growers who produce an annu-

al crop under 1 000 tons.

The interest is a fixed 10 percent over a 10-year repayment period although many of the growers make settlement within six years.

Glendale, despite being the smallest sugar mill in Southern Africa, last season received the highest percentage for any mill from growers and their dependence on this reliable source is steadily increasing.

Zululand born-and-bred, Gavin Wiseman, agriculture manager for the mill, said the black growers' contribution to the mill has risen from 30 000 tons in 1975 to 133 000 tons last season, which provided a net profit for the local black growers of about R2,2m.

Glendale

The size of the plots at Glendale average about two hectares and they are determined and allocated by the tribal chiefs; but as Mr Wiseman points out, two hectares only produce between 50 to 75 tons of cane per hectare every two years.

'The plot sizes are insufficient to generate a full time wage, so it's more a discretionary income, but it does provide a useful injection to their incomes,' Mr Wiseman said.

Most of the owners are migrant city workers who leave the running and care of their plots to their families and wives and return to 'farm' at weekends.

Growers at Glendale are classified into dry areas, which are dependent on natural rainfall in the higher altitude areas, and wet areas which are irrigated from the Mvoti River.

Glendale has two areas under irrigation.

The smallest is the gravity-fed Mthandeni irrigation channel scheme, which was designed and built for vegetables in 1954, but converted to cane ten years just after FAF started.

The 98-hectare scheme with 36 participants had long been a source of hope and expectation to other growers on the opposite banks of the river, but it was only in 1982, after a severe drought had slashed their yield from 80 tons per hectare in 1980 to virtually nothing, that the other villagers made a firm resolution to have their own irrigation.

Scheme

The topography of the land precluded a gravity fed scheme, like the Mthandeni.

The only suitable irrigation would be through a sprinkler system whereby the water, at considerable expense, would have to be pumped up from the Mvoti.

Mr Wiseman said the Mansomini irrigation scheme was an entirely self-initiated project by the villagers, who paid the development costs and are responsible for the repayment of the loan which was put up by the fund and the Kwazulu Development Corporation.

Project

'The project required tremendous support and co-operation from the local chiefs, the Kwazulu Department of Agriculture and Forestry and the locals and it is a testament to their co-operation that it has become a reality,' Mr Wiseman said.

Much of the inspiration and motivation for the project came from Mrs Cecilia Khuzwayo, a great-grandmother in her 70's, who had also been the prime mover in galvanising her fellow villagers into digging rudimentary roads in the early 50's to allow the first vehicles into the area.

A legend

'She's a real leader and motivates people by the sheer strength of her personality. She also controls the thinking of the community in a most positive way and not in a dictatorial fashion,' Mr Wiseman, who has known her for many years added.

Mrs Khuzwayo is indeed a legend.

As she stands proudly surveying the new pumping station on the banks of the Mvoti which feed the Mansomini scheme's sprinkler system, she smilingly recounts some of the bitter opposition to the scheme and how, after completion, the most eager detractors were won over.

Promise

The scheme has already produced its first cane and is a tangible promise to 345 applicants who now patiently wait for a share in the other 935 hectares earmarked for irrigation that Mr Wiseman believes, subject to funds, will be completed by 1990.

Such is the overall success and the desire to own their own plot that there are a further 700 prospective Zulu growers waiting for plots in the dry-land areas. The Fund has also established three community farmers' centres and a community hall.



The tall cane supplies a successful backdrop to the efforts of four key members of the Glendale Sugar Mill involved with the small cane farmers in the area — from left: Mr Gavin Wiseman, (Agriculture Manager), Mrs Dorothy Mthimkulu (manageress of Mthandeni irrigation scheme), Mr Elk Ntshangase, (Development Supervisor), and Mr Tony Newson, (Development Manager).



A worker at the Mthandeni scheme re-routing an irrigation channel.



A legend — great-grandmother, Mrs Cecilia Khuzwayo, who spearheaded the Mansomini irrigation scheme which she now manages for the 63 participants.

Dieldrin found on sugar cane farms — Minister

By BARRY STREEK
Political Staff

PARLIAMENT. — About 200kg of the killer poison Dieldrin were found by Government inspectors on Natal sugar cane farms earlier this month, the Minister of Agricultural Economics, Mr Greyling Wentzel, said yesterday.

And, in reply to a series of opposition questions in the House of Assembly, it was said Dieldrin was exported from South Africa to Swaziland, Zambia, South West Africa and Botswana.

A team of 35 inspectors visited 400 sugar cane farms in Natal between February 5 and 7, Mr Wentzel said in reply to a question tabled by Mr Errol Moorcroft (PFP, Albany).

The inspections were held after "recent allegations in the media that Dieldrin is being used on sugar in Natal", Mr Wentzel said.

But he said "no evidence could be found that Dieldrin is still being used".

He also said no instances of Dieldrin contamination had been reported in the past 12 months, nor had any contamination of food resources been reported.

However, "approximately 200kg of Dieldrin which is more than six years old was found on farms".

The Deputy Minister of Trade and Industry, Mr Kent Durr, said in reply to a question by Mr Peter Soal (PFP, Johannesburg North) that Dieldrin was not manufactured in South Africa but "technical Dieldrin" was imported and formulated into a usable form.

The use of Dieldrin was not permitted in

either South Africa or SWA but "import permits have been issued to Shell Chemicals (Pty) Ltd to import materials for the chemical industry, which may include technical Dieldrin".

Dieldrin was exported to Botswana, Zambia, Swaziland and SWA.

Mr Durr said neither his department nor any agency falling under his department was involved in the export of the substance.

The Rand Daily Mail Correspondent in Cape Town reports that Dieldrin was used on pineapple farms in the Border area of the Cape until early last year.

This was confirmed yesterday by the registrar of agricultural and veterinary drugs, Mr Max Orban, who said a special dispensation was given to members of the Pineapple Growers' Association (PGA), despite the ban on the chemical.

The dispensation was given in 1982 and renewed in 1983 specifically for the control of white grub. The concession was ended in March last year when an alternative insecticide was found.

Mr Orban said the exemption to pineapple farmers in the Border area had only been made after discussions between experts from various departments.

He said it was distributed under the strict control of the PGA and when the concession was ended the Shell company undertook to remove all stocks. The Department of Agriculture had checked that this had been done.

● Although Mr Wentzel said Dieldrin is banned in SWA, it appears from his reply the poison is being used there to fight tsetse fly.

BE INFORMED — BE A SUBSCRIBER

Have your newspaper home delivered
and SAVE 16% Tel 633-2579

The Star
TELLS IT LIKE IT IS!

The Star

Gold

London open.	\$290,40/290,90	O
Zurich open	\$290,20/290,70	A
Hong Kong close	\$291,26	It

No capital return for three years

Why sugar industry puts up price again

3 Sugar Star 15/3/85

By Duncan Collings

Deputy Financial Editor

The South African sugar industry will record a shortfall of R157 million in the 1984/85 season ending in April this year and is headed for an estimated R200 million shortfall in the 1985/86 season.

However, the industry will not raise further loans in either of the two years but will absorb the shortfalls, says SA Sugar Association general manager, Mr Peter Sale.

Mr Sale outlined the state of the finances of the sugar industry at a press briefing at which the 14 percent increase in the industrial price and 12,5 percent increase in retail price of sugar was announced.

The shortfalls are based on a formula whereby allowed cost of production includes roughly a 16 percent return on capital and thus the true picture is that in the current season actual costs of production and income were nearly in balance and a small shortfall is anticipated for next year.

RECORD CROP

But the industry has had no return on its capital investment for three years and is already indebted to the tune of R327 million, and Mr Sale says that in his opinion the industry has reached the limit of its borrowings and thus will have to absorb the shortfalls.

The crop for the current season, ironically, will be a record 2,74 million tons. The domestic market will take 1,2 million tons and the balance is available for

export.

In view of the depressed state of the world sugar market, the local industry will not be exporting all that it has available and has started stockpiling sugar.

There are currently 500 000 tons stockpiled which is virtually the capacity of the sugar export terminal in Durban, but no decision has yet been taken to increase storage capacity by erecting the proposed fourth storage facility.

The industry will lose R277 million on its exports in the 1984/85 season and exports the following season will continue to run at a similar loss, says Mr Sale, unless there is a dramatic and, at the moment, unexpected increase in the world sugar price.

Further down the line Mr Sale is confident that the world sugar price will increase again as a number of world sugar producers withdraw from the market as they will not be able to absorb the losses on their exports.

On the export front the 70 000 tons a year export contract to supply Israel with refined white sugar comes up for renewal shortly and if negotiations are successful a bulk white sugar export storage facility will have to be erected.

The existing terminal handles only unrefined raw sugar.

The domestic market ran at a R76 million surplus last year after a loss of R193 million the previous year, and after taking into account the latest announced increase in produce

an estimated R20 million surplus next year.

Mr Sale said that all of the industry's loans — the majority of which are denominated in US dollars — have been covered and the industry therefore recorded no foreign exchange losses.

But rising interest rates have hurt the industry and interest last year was R47 million and will probably rise to R50 million next season.

The cost of interest is included in the estimated loss figures for this and next season.

LOCAL INDUSTRY

Referring to the latest price increases, Mr Sale said that it is true that while the world price remains extremely depressed, at present sugar could be imported into this country and sold for less than local sugar, but as soon as the world price recovers, which it must do shortly, this will no longer be the case.

He pointed out that one cannot simply mothball the local industry while imports are cheaper and then re-activate it again when the world price once more rises above the local cost.

He points out that the local industry directly supports 186 000 people and indirectly more than another one million.

He says that if the local industry were endangered it would destroy the structure of Natal and Kwazulu and would swing an average of R180 million in foreign exchange earnings into a R500 million deficit based on the current world price for import of sugar.

In past 10 years sugar prices have risen over 300 percent

1984
16/3/85
S. Karan Shan

Increase will have ripple effect

Mr Bernard Hellberg, assistant director of the Consumer Council, said: "In a sense we are dealing with a luxury but we are afraid that we will probably see the soft drink manufacturers using this as justification for a price increase in their product even if it contains artificial sweeteners.

"The increase will affect biscuits, jams and sweets. But you can survive without them."

Mr Richard Cohen, a director of Pick 'n Pay, said the price increase was not unexpected.

"One has a lot of empathy for the sugar farmers but on the other hand it's another nail in the coffin of inflation and the man in the street.

"We have certain stocks of sugar and while these last we will keep the prices down. It is difficult to say how long this will be."

Miss Peta Lomborg, Checkers' public affairs manager, said: "Any sugar increase at this time will fuel inflation because it has repercussions on so many other products.

"We do have some stocks and we obviously will hold the price for as long as we can depending on the quantities people buy.

"The increase could start impacting on the other products in anything from two weeks to two months, depending on the product and how far production is ahead of demand."

Mr Phillip Botha, deputy general manager (local market) of Langerberg Koop Canned Foods, said: "Although this is a substantial increase we will have to absorb it because our last increase — an average of 5.8 percent — was only on March 1."

Mr P Beyers of Cadbury Ltd said: "The increase was expected and this was taken into consideration when we worked out our pricing policy this year. Some products have already gone up and others will go up in the near future."

But Mr K Blumberg, chairman of the Sweet and Chocolate Association, said he had no mandate to comment for the whole industry but the price of sugar would most definitely be passed on to the consumer.

by Maud Motanyane and Jackie Ushin

A spoonful of sugar won't help the medicine go down this time. The increase in the retail price of sugar announced on Thursday, which will result in an increase of about 12.5 percent in the consumer price, will have a ripple effect on about 200 household shopping items.

The retail price of sugar has increased by 39.88 percent over a 12-month period.

There is no price control on either the wholesale or retail prices of sugar, but it is estimated that the retail price of a 2.5 kg pack of white sugar will go up by about 25c from about R1.96 to R2.21, and that of a 1 kg pack of brown sugar by about 9c — from about 73c to 82c.

But at least some of the manufacturers of sugar-based products said their prices would not rise any further at the moment because the sugar price rise had been anticipated and built into this year's pricing policy.

'Disastrous Drought'

This is the second sugar price increase within six months.

Mr Ian Smeaton, chairman of the SA Sugar Association, said the price adjustment in September 1984 was necessary to provide some alleviation to the industry following the serious financial problems resulting from the disastrous droughts.

He said the new price increase will bring the industrial selling price up to the level of the estimated cost of production for the 1985-86 season.

Mrs Joy Hurwitz, president of the Housewives League, said: "I fail to see why in a recession we must have an increase in this commodity. There has been an over 300 percent increase in the sugar price in the past 10 years.

"In a recession an increase of this size is unacceptable whatever the state the sugar industry is in. Consider the state consumers are in. We cannot afford an increase of this size.

"I hope and pray we are not going to have similar rises with maize and bread prices, which

Business Day

More sugar for export

By PRISCILLA WHYTE

SUGAR exports, according to the latest South African Sugar Association (SASA) estimates, are expected to increase to around 1-million tons for 1985.

However, raw sugar export prices have tended to soften during the last year.

A year ago, according to Mr Peter Sale, general manager of SASA sugar export prices averaged £113 a ton for raw sugar and \$165 a ton for white sugar.

The London raw sugar price was around £88 a ton this week and the price of white sugar was \$130,50.

Mr Sale does not see any major change in the sugar price for the foreseeable future and expects the price to drift between £80 and £100.

SASA does not envisage installing a fourth sugar silo for export sugar storage because of the current debt situation — R327m — in the sugar industry.

Mr Sale says exports during the new season starting May 1, 1985, and ending April 30, 1986, will not enable a repayment of loans but the interest commitments of R50m will be met.

Domestic consumption amounts to 1,3-million tons a year. The recent hike in the local sugar price seems to have been accepted by the market although it is believed that consumers, who anticipated the increase, stockpiled supplies.

The local industrial sugar price increased by 14% in early March when the international spot price had come down to £99 a ton from a peak of £650 in 1974.

This resulted in a price increase to the consumer of about 12,5%.

However, the spot sugar price differs markedly from that on the domestic market of sugar producing nations.

The domestic sugar price per ton in Australia was R966, West Germany R942, Holland R1 032, the United Kingdom R824, the US R1 283 and SA R658 in March 1985.

ing), says a Sats workshops spokesman.

Changes will also be made to other facets of Sats' container handling system, he says.

Rail trucks will have to be converted to accommodate the new-size containers, but "the total costs here have still to be worked out."

However, finance has been allocated for the first 8 000 units to be built this year, and the first eight of a pilot batch of 88 have been

made.

Gavin Millar, GM of Middelburg Steel's sales and marketing division, estimates that up to 15 400 t of stainless steel, worth about R28,4m, will go into the container contract.

A Sats marketing spokesman says the new generation train-sets on test were made by Japan's Hitachi and Germany's MAN. But he says Sats "may mix some of the better features of one set into another in our final

choice."

Financial provision has already been made for the first eight stainless steel 12-coach sets, with every second one motorised. These will be 275m long — the same length as the 14-coach trains now operating — but will be lighter, faster, stronger and easier to clean and maintain.

They will be used on the Soweto-Johannesburg route and in the Cape. ■

AGRICULTURE

Crookes into crocs

3 Sugar

FEATURE

Crookes Brothers has a message for Natal's sugar farmers looking to diversify in the face of falling international sugar prices — get into crocodile farming.

Hitherto croc farming has been the preserve of a few plucky tourist entrepreneurs who capitalised on people's tastes for the offbeat and bizarre.

Crookes' venture on the Natal South Coast, the first commercial crocodile farming operation of its kind in the country, removes reptile farming from the realm of pure tourism. Further, it puts the seal of legitimacy on what could be a burgeoning new business in which SA is well placed to corner major world markets.

On 17 ha of land previously planted with cane near Scottburgh, the company has spent R3,2m on creating the third-largest crocodile farm in the world, run by world-renowned crocodile expert and former Parks Board game ranger Tony Pooley.

Crookes Brothers MD Dudley Crookes admits the move was made with diversification in mind. He says it was board policy that the company should diversify, but the bottom line was that it should stay in agriculture.

That turned out to be more difficult than it seemed. With the high level of interest rates and the rising cost of farm land, one of Crookes Brothers' priorities was to see how it could profitably put its own farm land to use. One of their assets happened to be an abundance of water.

"We looked at prawns, oyster farming, freshwater fish ... the lot, before we tumbled on the idea of crocodile farming," explains Crookes. "Our feasibility studies showed that there were good markets for crocodile skins in Europe and the far East which, as far as we could ascertain, were under-supplied."

According to Crookes, the supply of skins to tanneries is diminishing because the trade is increasingly attracting the attention of the Geneva-based Convention for International Trade in Endangered Species (CITES). The legal supply of skins is down to about 3,5m/year compared with 5m a few years ago. Many tanneries have closed as a result.

Crocworld was started with a nucleus of 60 breeding females, 13 males, 10 sub-adults

and a host of hatchlings mostly sourced from Botswana and Zimbabwe (in SA crocodiles are recognised as an endangered species and may not be captured commercially).

Crookes says he hopes to build the croc population to around 8 000 in five years which should provide him with about 2 000 hatchlings a year. The skins from these will be sold to tanneries in Europe and the far East for which contracts have already been negotiated.

On paper, at least, the business appears to pay handsomely. A crocodile takes three years to reach culling stage during which it consumes roughly R120 worth of fresh meat and fish. A 32 cm skin with a 15 cm belly width sells for around \$300, and more in some cases.

Then there is the meat. Crocodile flesh is regarded as a delicacy in many parts of Europe, the far East and the US.

On the initial R1,5m investment in the farming operation, Crookes says he hopes to be seeing a return of around 18% in three years. On the tourist side of the business, which includes a restaurant appropriately named *The Crocodilian*, he is looking at around 30%. "That's a lot better than one

can do in agriculture these days," he observes.

Ultimately Crookes says he would like to establish a tannery on the site. It would, however, require a population of 30 000 crocodiles and a supply of 10 000 skins a year to be viable. It remains a long-term objective, but the IDC has already said it will consider providing a soft loan to cover the investment.

Other downstream products could include freshwater fish farming in the effluent ponds into which all the breeding and rearing ponds drain, and possibly exotic flowers fed on the nutrient-enriched waste water.

Other farmers, including some in the climatically suitable eastern Transvaal, are said to be watching Crookes Brothers' progress closely and are prepared to cash in if the crocodile skin market proves to be as lucrative as forecasts indicate.

But, novelty of the undertaking aside, entry is by no means easy. Just for starters they will have to satisfy the rigid requirements of CITES.

Happily, that's one hurdle which Crookes, as the only CITES-approved skins dealer in Africa, has already managed to surmount. ■



Crocodiles ... hatching a new industry

3 Sugar

QUOTAS TO INCREASE PRICES?

Farming's maize and sugar sectors are set to change the basis of their pricing systems. They will do this by exposing the price of production in excess of domestic consumption to the risks of world prices. Production in terms of quotas to the level of domestic consumption will be given guaranteed prices, based on production costs and the inflation rate.

The rationale behind these changes is that farmers should not be given an incentive to produce unlimited crops by a single price. Instead of market prices signalling what and how much farmers should produce, control is imposed by paying fixed prices only for quota production based on domestic consumption levels.

The sugar proposal is for an A-pool and B-pool system. The A-pool will have a

requirement of 1,8 Mt of sugar (1,3 Mt of sugar for SA and 500 000 t of contractual export sugar). The price will be based on the costs of production.

For the B-pool, farmers will produce entirely at their own risk as prices will be based entirely on export market prices. Presently, these are substantially lower than the SA price.

The sugar industry contends that the restructuring should be beneficial as the present average price system, based on domestic and export prices, has tended to disguise the true cost of producing for individual markets. In addition, the need to maintain quotas resulted in producing at maximum capacity — irrespective of whether land was marginal or not.

The proposed system for maize farmers is based on the same logic as the sugar

growers' pool system, but no date of implementation has been set. It is thought that the system, based on costs of production, could substantially increase domestic maize prices.

The sugar industry will implement its proposed multiple pool system in the 1985-1986 season. Unfortunately, the change is unlikely to effect local sugar prices.

So it seems that the proposed quota systems will do nothing for domestic prices, and may actually increase them. More worrying is that quotas, such as KWV's wine quotas, tend to acquire a value of their own, for the produce from quota land gives a guaranteed income. Indeed, the principle of quotas is contrary to the change to market pricing systems now sweeping the world.

out of the pricing system. That seems a fair expectation, given that the farming regulatory system has not been updated since 1937.

Another vital move is the deregulation of SA's 320 farming co-operatives, with their R10 billion/year cash flow and extraordinary market powers. These co-ops are a pivotal component of agriculture and could be quickly unshackled to participate in a

freer market.

But the final determinant might be the current recession and the necessity for government to trim spending to current revenues. By reducing the huge flow of subsidy funding to the farm sector and also refusing to grant excessive commodity price increases, government could give agriculture the medicine it so sorely needs.

Forced insolvencies could weed out inefficient producers, push down farm prices and reduce the strain on the taxpayer. Simultaneously, more moderate produce price increases — also egged on by growing consumer resistance — could reduce expensive surpluses and bring the whole of agriculture closer to the market-related, realistic level that would benefit the whole economy. ■

PERSONAL SAVINGS

And then there was none . . .

South Africans should be saving, but they are not. On the surface, attractive propositions abound. For example, assuming that inflation will average 12,5%/year over the next three years, current long-term rates should yield a real return of 4%/year. Few investors would jib at that. The reason they do is not difficult to see: the propensity to save is being undermined by nagging inflationary expectations and, as bad, the demoralising effect of high marginal tax rates.

Over the past eight years, personal savings have dwindled to a meagre 8,2% of gross domestic savings from a high of 29,2% in 1977. Since that year, there has been a 70,8% drop (in 1977 rand terms) from R2,864 billion to R835m at the end of 1984. To make matters worse, savings have declined dramatically in real terms — notwithstanding the massive weight of contractual savings through the life assurance industry and private pension schemes.

On the other hand, corporate savings as a percentage of gross domestic savings rose to 35,9% in 1984 from 15,6% in 1977.

What should alarm economic policy-makers is that, since 1977, total savings have risen only 3,7% in real terms, while gross

The decline of personal savings is alarming. It reflects a kind of condemned-man syndrome. Despite attractive long-term yields, the pervading mood is to spend rather than surrender proceeds to inflation and the taxman.

domestic investment has increased by 13%. The difference has been made up by borrowing overseas, often short term.

Savings can come from three sources — individuals, corporations or government. But

if the level of total savings is to keep pace with SA's need for investment, then corporate and government savings are not enough — the present downward trend in personal savings will have to be reversed.

Saving money is essentially a hedge against inflation for the man-in-the-street. Although projections for inflation vary, a reasonable, if not slightly optimistic view would peg it at an average of 12,5% for the next three years. For example, an individual who puts money away in fixed deposit for three years could expect, at present rates, his investment to grow at 16,6%/year.

But tax casts gloom over his expectations.

PERSONAL SAVINGS — CONTRIBUTING LESS Components of savings as a % of Gross Domestic Savings

	1977	1978	1979	1980	1981	1982	1983	1984
Personal	29,2	19,1	21,1	18,3	11,1	9,0	6,9	8,2
Corporate	15,6	22,9	29,3	34,3	34,5	24,7	35,4	35,9
Government	5,2	7,9	7,1	10,9	7,3	1,5	-3,8	-8,8
Depreciation	49,9	50,0	42,4	35,9	47,2	64,8	61,5	64,7

Source: Reserve Bank Bulletin.

By Duncan Collins
Deputy Financial Editor

Little relief in sight for sugar industry as

World price slumps

3-Sugar

Star 9/5/85

The drastic fall in the world sugar price is putting further pressure on the already beleaguered local industry and there is very little chance of any relief in the medium-term future, according to Mr Peter Sale, general manager of the South African Sugar Association.

"In fact the world price seems destined to decline further," he told *The Star* in an interview.

Mr Sale said it was extremely difficult to predict when world sugar producers were likely to come up with a workable solution to massive overproduction and large stocks.

This was because it was impossible to gauge the degree to which other producers are subsidised by government either through a direct production subsidy or a high enough domestic price of sugar to cover the full cost of production of their total crops.

Many major producing areas — including the very big European Economic Community (EEC) sugar beet producers — did not feel the effects of the slump in world prices because their production was subsidised.

Consequently ~~there~~ was practically no pressure to bring the world market back into balance.

In countries like South Africa and Australia with no subsidy and exports at a heavy loss, the industries were being severely harmed.

Mr Sale said he found an increasing awareness among other producers that something had to be done.

"Even in the EEC which traditionally has been fully subsidised, the subsidies are being cut back and pressure is building to take active steps to improve the world market by reducing production or holding back on exports."

Mr Sale pointed out that surplus

world stocks — that is stocks in excess of safe and normal levels — now total nearly 15 million tons. This compared with the total volume of sugar traded on the world export markets in an average year of 17 million tons.

"It will take many years to work this surplus off whatever agreement may be reached by producers," he said.

On the local front he said there were no plans to press the Government for a further increase in the domestic price of sugar after the recent increase announced in April.

But the fall in the world price meant "our income no longer matches up to the calculations we did to set the domestic price and we are starting to lose out".

To assist local producers and cut back on South African production, making the industry less reliant on the unprofitable export market, a two-tier marketing system was introduced this month.

The A pool of 1.8 million tons comprises 1.3 million tons for the domestic market — where the price is set to cover both the cost of production and fair return on capital.

The balance of 500 000 tons is destined for the export market at world related prices.

"Thus even income from the A pool will be below the industry formula, of cost of production and return on capital for farmers," Mr Sale added.

From the B pool, which based on the past season, would have a further 500 000 tons for export at market-related prices, producers would receive an amount which would not even cover basic cost of production.

The volume of deliveries to the A pool were fixed on a quota system for all producers, while deliveries to the B pool were at the discretion of producers.

A bitter dilemma *FM 17/5/85*

If they weren't so serious, the labour problems faced by C G Smith Sugar as a result of multi-level bargaining would be almost comic.

Inter-union rivalry at Smith's sugar mills has reached such a pitch that it has become impossible to implement effective wage agreements. As a result, management has thrown away the rule book and has resorted to crisis measures to keep industrial peace.

Observes personnel director Barrie Horlock: "This is one problem where you won't find the solution in a university business school library."

The problem stems from inroads made by Fosatu's Sweet Food and Allied Workers Union (SFAWU) at Smith's mills where it is squeezing out the larger National Sugar and Refining and Allied Industries Employees Union (NSRAIEU).

The NSRAIEU, headed by Selby Nsi-bande, negotiates at industrial council level and SFAWU negotiates at a corporate level on behalf of unskilled and semi-skilled workers at Noodsberg, Umzimkulu and Pongola mills. To implement agreements struck with SFAWU, exemption from the industrial council agreement is required.

Last April agreements were reached with both parties. While the packages differed in details, the cost of the awards was roughly comparable. Exemptions from the industrial council agreement were granted — except at Pongola where the NSRAIEU claims to be representative. Rival union claims at the

plant have given management a big headache.

Says Horlock: "It became clear that both SFAWU and NSRAIEU had 50% support at Pongola with the majority of 51% swinging backwards and forwards almost on a daily basis. All employees are accommodated on company property and the tension and rivalry, both within the factory and the village, was reaching impossible levels."

After consultations with the unions, it was decided at the beginning of this year to implement both agreements at Pongola for a period of three months (April to June). Thereafter, an audit will be conducted to establish whether a clear majority has emerged. In the interim, employees may vary their employment package merely by switching unions.

But as Horlock says: "At least that is better than changing the whole labour force as the majority swings between the two unions."

Meanwhile, negotiations for the 1985 agreement have begun at both industrial council level with NSRAIEU and at plant level with the SFAWU. But there are indications that SFAWU now has the majority at its biggest mill, Sezela. So in future it seems likely that exemptions will have to be extended to include Sezela. Clearly C G Smith will have to re-examine its relationship with

the industrial council unions.

Notes Horlock: "It seems like the multi-union industrial relations problem, a scenario sketched by academics, has arrived. We must keep a cool head and take the right decision at the right time ignoring, if necessary, the law and the text books. Our objective remains to maintain a happy and contented labour force in what is a very complex situation." ■

'Next 2 years important for S A sugar industry'

3-Sugar

NM 2/15/85

Finance Reporter

THE NEXT two years would be very important to the future of the South African sugar industry, according to Mr David Hardy, export manager of the South African Sugar Association.

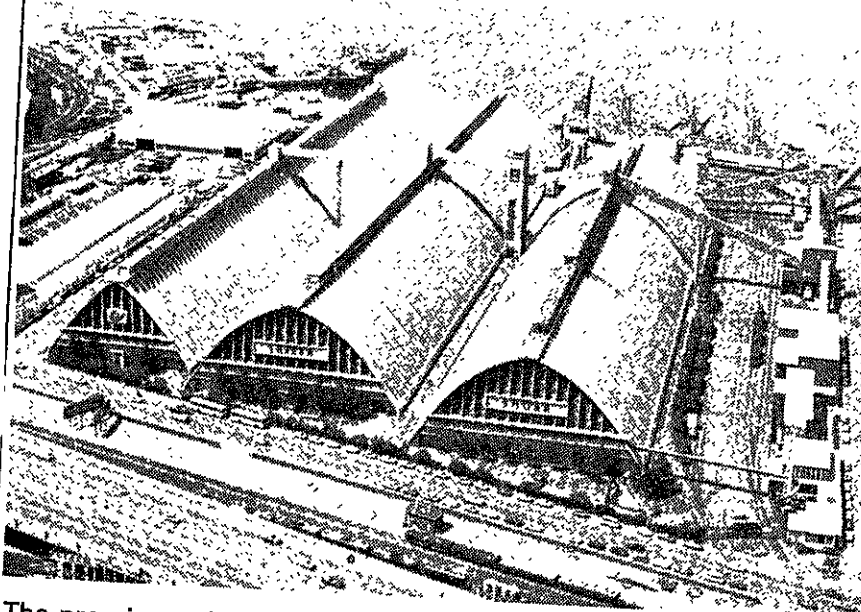

The prominent three massive dome-shaped silos of the Bulk Sugar Export Terminal at Maydon Wharf, which celebrates the 20th anniversary of its first export shipment today.

Mr Hardy was speaking at the 20th anniversary of the Bulk Sugar Export Terminal which, with its three massive dome-shaped silos, has grown to become one of Durban's more prominent landmarks and busier centres, having bulk-loaded over 14,9m tons of sugar to 939 ships for distribution around the world.

Mr Hardy said that within those 24 months 'the impact of the world economic sugar situation, which has been brought about by five successive world seasons of surplus production, would have taken its effect and countries would have either cut back production to reduce the world surplus or gone out of production.

Exports

He said that although South Africa might have to reduce the size of its production during the period and make other considerations that would mitigate against reducing the size of its export quota, it would still maintain its export availability.

He said that South Africa was very conscious of its contractual arrangements with countries such as Japan — South Africa's biggest sugar customer — Canada, Korea and Israel, and would be meeting those commitments.

'Another major problem threatening the industry was the inroads being made by artificial sweeteners into the traditional sugar preserves, Mr Hardy said.

'The whole of the US mineral water industry has changed from using sugar to alternative sweeteners and this has probably cost the industry 3m tons of sugar.'

teners

rs, bakers and manufacturers also gone over to alternative sweeteners and this could probably bring the total to 4-1/2m tons of sugar lost to the industry.

Yesterday at the terminal there was little sign of celebration of its 20th anniversary as the Press were conducted on a tour, and it was very much a case of business as usual as the MV Bright Star was being speedily loaded with 16 000 tons of sugar destined for Japan.

The terminal, which has a storage space of 520 000 tons of sugar has certainly justified its inception since it delivered its maiden load to the MV Celerina which was also bound for Japan 20 years ago.

But probably the most startling fact to emerge from the tour was that if a terminal replacement of the same size had to be built today, it would cost over R100m to replace the complex which came on line for R15,5m.

Terrorists frighten off the sugar investors

(3) Sugar
B. Day 24/5/85

By ALAN PEAT

TERRORIST activity in Mozambique is frightening off would-be South African investors in the country's ailing sugar industry.

A joint study between C G Smith Sugar and consultants E L Bateman into the industry was started towards the end of last year.

This followed a Cuban report on the industry and was designed to assess the viability of a shareholding interest by C G Smith in a significant proportion of the Mozambique sugar-producing trade.

Mozambique produced about 380 000 tons of sugar a year before the industry collapsed, and now produces only 80 000 tons.

Preliminary discussions were held between representatives of C G Smith and Mozambican officials.

"Our standpoint at this stage was for us to have a controlling interest in the company to be set up to operate the sugar industry," said Glyn Taylor, MD of G C Smith Sugar.

Attention was focused on two mills — the state-owned Maragra and privately-owned Nkomati, respectively 70km and 100km from Maputo.

"Our next move would have been to take a multi-disciplinary group — agricultural, financial and technical — to assess the authenticity of the reports," said Taylor.

"But at this point civil insurrection just got too hot and we have had to put the situation on hold."

Mozambican sugar industry officials are to visit South Africa soon: Details of the Bateman report are not available for scrutiny.

"Everything to do with Mozambique and its sugar industry is just too sensitive at the moment," said Pete Theron, controller of the report.

He conceded, however, that the sugar industry there "is very much worth investing in", despite sabotage damage and the poor state of the present cane-growing land.

● Argentina said yesterday it would cut sugar exports and encourage other producers to follow suit in order to lift world prices from near-record low levels, reports Sapa-Reuter.

Argentine Sugar Association chairman Jorge Zorreguieta, in London for two days of International Sugar Organisation (ISO) executive council talks, said domestic production would be reduced so that exports would fall from 500 000 to 100 000 tons in the crop year.

Argentina accounts for only a small proportion of the 20-million tons a year world sugar trade, and any move it made would have little effect on prices.

Farmers

to get
R3 - Sugar
R375 000

NM 25/5/65
payout

Mercury Reporter

INDIAN sugar farmers in Natal are to receive a R375 645 payout from the Equalisation Fund of the Sugar Industry Central Board this week.

Mr Arjun Jagessur, secretary of the Natal Indian Cane Growers' Association, said yesterday that farmers should collect their cheques by calling on the mill group secretaries.

'This is an annual payout from the fund. It is a form of industrial levy on proceeds from the sale of sugar.

'At the end of each crushing season, the money is divided among farmers with the smaller farmers receiving a slightly higher payout,' he said.

Mr Jagessur said this was in addition to the normal payment farmers received for the tonnage of cane supplied to the mills.

A total of 1 456 cheques with amounts varying from R3 to R1 279 were made out for payment to farmers, he said.

Ethanol plants decision

faces sugar industry

DECISIONS about substantial capital spending on setting up ethanol plants and additional refineries face the sugar industry Mr Frank Jones, chairman of the S A Sugar Millers' Association (SASMA), said at the annual meeting yesterday.

Jon Beverley
Finance Editor

NM 30/5/85

DATA

● R8,4m has been spent on the bulk sugar project;

● The past season had a shortfall of R162m, which was absorbed by millers and growers but which led to a 'financial crisis of unprecedented severity and one in which many producers faced disaster';

● Mills received R11,8m in compensation for the scrapping of tramlines and changes to other transport facilities, which will lead to annual savings of R4,1m — a three year recoupment period;

● Restructuring in the industry (transport and the creation of the pool system) has led to a fall in employment and 'sizeable number of redundancies over and above natural wastage';

● Pressure is mounting on sugar producers to cut input costs. This is already leading to lower fertiliser applications resulting in lower yields, which would create sugar shortages and thus better prices;

● Russian sugar imports are expected to decline and India and Brazil could switch emphasis towards massive exports while China, a potentially major buyer, will probably step up plantings at home.

pect of making any return on capital and will 'indeed face a deficit on its cost recoveries.'

Cane quality could be improved, Mr Jones said, indicating that this would receive attention as there was room for improvement of up to 20 percent.

While it would be unrealistic to believe that the gap could be closed entirely there 'is room for meaningful improvement.'

Other points were:

● Mills had very good recovery figures — the highest since 1979 of 88 percent in the boiling house and 97 percent extraction;

● Domestic market sales rose 4,23 percent, but removing distortions the real growth was estimated at 'nearer two percent,' which was below the long-term average growth of 2,7 percent;

● Black consumers (they account for 72 percent of soft drinks) are resisting artificially-sweetened products;

● Confectioners' use grew by 5,3 percent and fruit and vegetable canners by 2,1 percent, reflecting better exports;

● SATS has built 53 special sugar trucks to take bulk sugar to the Transvaal and will build another 72 in the next three years;

Sugar brokers have been indicating a shift in demand by world sugar users for refined rather than raw sugar and this has also been shown by the higher refined sugar premium.

If this continues, says Mr Jones, the industry would have to give serious consideration to substantial new capital investment in refineries.

With structural changes taking place in the local sugar industry the millers are looking at ethanol production and whether it would attract 'the sizeable capital investment' needed.

Review

Presenting his annual review of the industry Mr Jones said that it did not appear that there would be a recovery in the world sugar price before the middle of 1986.

South Africa's export proceeds had been rescued by the slide in the rand against the dollar; but the industry was facing the lowest price in 15 years and the lowest in real terms ever of \$83 a ton.

Prospects for the crop were that unless there were good soaking rains soon there would not be a large crop. Estimates were for about 2,1m tons of sugar.

Last season saw a record 2,3m tons.

Mr Jones said that rising costs indicated that South Africa has no pros-

The Natal Mercury, 1

'A new industry would create more jobs'

Jon Beverley
Finance Editor

ETHANOL production is firmly back on the sugar industry's agenda. It is now evaluating the prospects, according to spokesmen at yesterday's annual meeting of the S A Sugar Millers' Association (SASMA).

The chemical, distilled from sugar cane waste, can be used to extend or replace petrol while research is being done to see whether it can extend diesel fuel.

A proper study of the matter is now needed, with the sugar industry providing the impetus, which would deal with all the aspects and organisations concerned. Faced with a probable decline (some estimates are up to 10 percent, or 200 000 tons of sugar) in sugar output as the industry reacts more closely to the world sugar price, the millers are searching for ways to maintain throughput.

Technically, says Mr Frank Jones, SASMA chairman, there are no insurmountable problems in making ethanol from sugar cane.

A positive factor is the ability of ethanol to replace highly toxic lead as an anti-knock additive, 'a concept that is attracting support from environmentalists the world over.'

An ethanol industry would create jobs, Mr J D Kritzinger, vice-chairman, pointed out, saying 'substantial benefits could flow from such a venture for the industry as well as the general population and Government of the day.'

It could create an economically more stable area along the border area and in KwaZulu and KaNgwane — which must also be of considerable importance to the Government.

Negative factors, says Mr Jones, are the commitment to producing petrol from coal by Sasol; the need to talk to the oil companies on ethanol distribution; the difficulty of a guaranteed ethanol output as harvests vary; and the current surplus of petrol.

It would seem that its use as a diesel fuel extender would be more practical but the practical aspects have not been researched and 'we could not say with total certainty that it is a commercial proposition.'

Another practical aspect would be the price competitiveness of the raw material — sugar cane — measured against crude oil prices.

Sugar industry urged to consider alcohol fuel

Finance Reporter

THE SUSTAINED low level of world sugar market prices and the increasing impact of alternative sweeteners should encourage the sugar industry to become low-cost producers and look for alternative uses of the product.

This was said by Dr J R Allen, director Sugar Research Institute Mackay, Queensland, Australia, who delivered the opening address at the 59th Annual Congress of the South African Sugar Technologists' Association in Durban yesterday.

Dr Allen, an international authority on sugar research, said that with the world production rate exceeding consumption it was a logical step for the sugar industry to give considerable attention to using alcohol fuel produced from sugar.

He said that Brazil, encouraged by attractive financial conditions to build distilleries, had done a remarkable job of reducing its oil imports by diverting sugar to alcohol.

Alcohol

'But it has not been the result of any special technological expertise on their part, because alcohol has been made in very similar ways throughout the world for many years. The difficulty lies in the cost of the feedstock if sugar is used.'

He said that nowhere in the world was there such a plant producing alcohol from sugar without some form of Government subsidy or some form of Government assistance.

'In Brazil, the sugar mill may produce sugar and/or alcohol and payment is based on 600 litres alcohol being equivalent to one ton of sugar.'

'This readily indicates that at R0,32 per litre, about the price for which they are selling alcohol, the equivalent price for sugar would be R192 per annum.'

'There are few, if any, who would build an in-

dustry on such a basis unless some form of subsidy was provided, especially when oil prices are reducing in real terms.'

Dr Allen said although the increasing effects of high fructose syrups (HFS) on the world's sugar markets were becoming a considerable concern, it was not in the best interests of the sugar industry to manufacture HFS from sugar cane or sugar products.

'This would help build the HFS market and encourage manufacturers to modify their plant and receipts to suit HFS, but after competing with ourselves we would lose out to feedstock suppliers using grain.'

Dr Allen told the congress that over the last 20 years the world's sugar industry had become increasingly aware of South Africa's technological expertise, 'especially in which you have led the world in cane and bagasse diffusion.'

Output

He cited Felixton II and Sezela as outstanding examples of technical excellence of the South African sugar industry for achieving remarkable increases in productivity.

Dr Allen said it was clear that short-term projects were required in the industry for immediate needs and some medium and long-term projects to build for the future.

'But ruthless reviewing is needed to terminate projects that have no future and a progressive updating of an overall plan of development.'

He said there was a clear need for short, medium and long-term projects and a spread of effort across basic, strategic and tactical research fields.

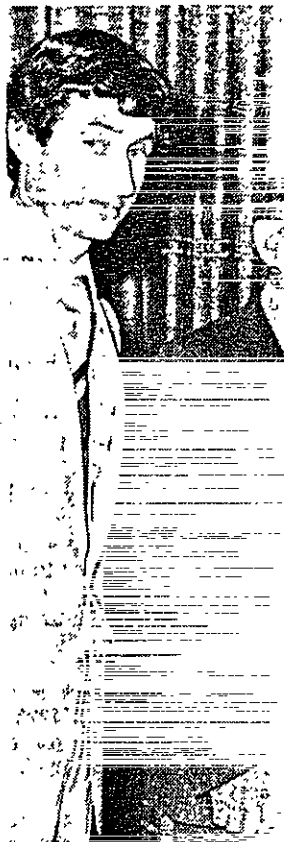

Some of the main speakers at the annual congress in Durban from Australia, who...

Farmers bid to scrap worker levy

Labour Reporter - SUGAR farmers on the Natal North Coast are planning to ask the Natal Agricultural Union to make urgent representations to the Government to scrap the present system of labour control on farmers.

In terms of the system, farmers engaging labourers are compelled to pay a levy of R1 a worker to the Natal Development Board.

A Natal sugar farmer, Mr N Coetzee, appeared in the Melmoth Magistrate's Court this week on a charge of non-payment of the levy, but the Magistrate, Mr J Bester, dismissed the matter after Mr Coetzee produced a receipt for the payment for his 36 labourers.

An irate Mr Coetzee told the Mercury afterwards that the levy on farmers was an absolute waste of money.

Neither the farmers nor the labourers get any benefit in return for the levy imposed by the board. Why should we continue paying this money?

The Government talks of a free market system and yet imposes a fee on farmers for each labourer working on the farms. This is unfair, he said, adding that farmers were planning to make repre-

sentations to the Natal Agricultural Union to take the matter up with the Government.

At its meeting last year, the NAU slammed the Government for ignoring the union's call for the abolition of administration boards in the rural areas of Natal. The union pointed out that the boards were imposing an unwanted system of labour control on Natal farmers, including the imposition of the levy.

NAU director Alywyn Bisschoff could not be reached for comment yesterday, but a spokesman for his office in Pietermaritzburg said the union was aware of the resentment among farmers concerning the levy and added that the NAU was pursuing the matter with the Government.

DURBAN — The SA Sugar Association currently has a debt of R327 million, which is incurring annual interest charges of over R45 million, says chairman Mr Ian Smeaton.

Addressing the association's annual general meeting, Mr Smeaton said the debt would have to be paid out of future surplus proceeds.

"It seems most unlikely that export prices will rise from their present low level fast enough to enable repayment of any portion of this debt, to be made from this source, in the near future," he said.

CROP RECORDS

Presenting the association's annual report for the crop year ended April 30, Mr Smeaton said that among several records established during the year was a record yield of 2 369 695 tons of sugar, which was nearly 1 million tons higher than the previous season.

But the industry's crop records were accompanied by record financial requirements to cover full costs of production and returns on capital.

"As a result the total proceeds fell short of full requirements by some R162 million. This meant that the industry had now experienced the longest period of time — almost three years — during which its members had on average earned no return on capital.

"The reason for the shortfall in proceeds during the past season was of course the fact that, in real terms, the world price of sugar reached its lowest point ever."

SA Sugar Association owes R327-m

3-Sugar
Mr Smeaton said that unlike many other countries, the SA consumer

provided no contribution towards or support of low export prices and the domestic price was set generally on the basis of the level of the cost of production of local market sugar.

To improve its financial position it had therefore, from the beginning of the 1984-85 season, changed the transport system, with growers now having to bear the full cost of transporting their cane to the mill.

"There should be scope for reduction in this major cost item, as in the last season the total cost of cane transport amounted to R113-million, representing nearly 20 per cent of total growing costs," Mr Smeaton said.

Another major change was the production pool system, introduced at the start of the current season. This consists of a two pool system, with the first pool totalling 1,8-million tons and comprising the local market tonnage plus the minimum quantities committed by contract to export customers. The second, voluntary, pool comprised

the balance of export production.

"With this introduction of further free market principles into the industry, it will be up to the individual grower or miller to decide whether his particular cost structure permits him to economically participate in the second pool. The current low world

25/7/85

sugar price could not last for much longer, because there were definite signs that world production was reducing, albeit not dramatically, Dr C van der Pol, vice chairman of the SA Sugar Association (SASA), told the meeting.

But he said it was impossible to predict sugar prices accurately. It was generally agreed that

world sugar prices could be expected to continue acting cyclically.

Current instability in world agricultural commodity prices, including sugar, would last about five years more.

The South African sugar industry had adjusted itself to the situation by tightening its belt — and would have to

tighten it some more if only to try to achieve a positive cash flow.

"I am not sure that the climate is yet favourable for negotiating an effective International Sugar Agreement in terms of which all exporters would make sacrifices."

He said that any unilateral action by South Africa, as one of the big pro-

ducers, in reducing its production by, say, 10 per cent would react favourably on the world sugar market.

But it would not result in a commensurate saving in fixed costs. Unit costs would be forced up and such action would be of no use to anybody. — Own Correspondent and Sapa

Turning sour to a tune of R327m

3 Sugar

Strong medicine to help the sugar deficit go down

B. Day
26/7/85

THE SA Sugar Association has a debt of R327m, incurring annual interest charges of more than R45m, chairman Ian Seaton said in Durban yesterday.

Addressing the association's annual meeting, Seaton said the debt would have to be paid out of future surplus proceeds.

"It seems unlikely export prices will rise from their present low fast enough to enable repayment of any portion of this debt, made from this source, in the near future."

RECORD YIELD

Presenting the annual report for the crop year ended April 30, he said that among several records established during the year was a record yield of 2,369-million tons of sugar, nearly 1-million tons higher than the previous season.

But the crop records were accompanied by record financial requirements to cover full costs of production and returns on capital.

"The total proceeds fell short of full requirements by R162m. The industry had now experienced the longest period, almost three years, during which its members had on average earned no return on capital.

"The reason for the shortfall was that in real terms the world sugar price reached its lowest point ever."

In a drive to make the South African sugar industry more competitive, the industry examined the level of the local market price and its competitiveness in the export market.

Seaton said that unlike in many other countries, the SA consumer provided no contribution towards low export prices

and the domestic price was set generally on the basis of the level of the cost of production of local market sugar.

"In times of drought, when unit costs of production soar dramatically, the local consumer has, under present procedures, not contributed at all to these increased costs and has paid less than the cost of production."

The SA consumer paid one of the lowest prices in the world for sugar. SA was also competitive in the export market.

But the fact remained that due to droughts and low export prices, income had been consistently below the level required to meet costs of production and returns on capital.

To improve its finances it had, from the beginning of the 1984-85 season, changed the transport system with growers now having to bear the full cost of transporting cane to the mill.

MAJOR CHANGE

Another major change was the production pool system introduced at the start of the current season.

This consisted of a two-pool system, with the first totalling 1,8-million tons and comprising the local market tonnage plus the minimum quantities committed by contract to export customers. The second, voluntary pool comprised the balance of export production.

"With these free market principles, it will be up to the individual grower or miller to decide whether his particular cost structure permits him to economically participate in the second pool. This concept should lead to the higher cost producers reducing over a period their production for the higher-risk second pool, leading to a stronger and more viable industry overall." — Sapa.

137 facing ~~the~~ retrenchment at sugar mill

Mercury Reporter

MORE than 130 people are to lose their jobs at the Sezela sugar mill on the Natal South Coast next month.

The workers, most of them Indian and black, have not been consulted but have learned that the company, C G Smith Sugar, plans to retrench 137 of them.

Many of the workers have been with the company for between 20 and 40 years. Some are close to being pensioned.

A mill worker with the company for 30 years said yesterday that people were having sleepless nights since news of the company's plans to retrench workers had leaked out this week.

He said many of them lived in company houses and had nowhere to go if they were sacked.

Mr Henry Zondi, organiser for the Sweet, Food and Allied Workers' Union, confirmed that the sugar mill had decided to sack 137 workers.

'We have had discussions with the company but no decision has been taken in connection with benefits for retrenched

workers,' he said, adding that a further meeting would be held next week to resolve the issue.

Mr Zondi said his union was opposed to retrenchments and would fight to the bitter end to stop any.

'If we cannot save the jobs then we will fight for a good deal,' he said.

He said the union had been informed that retrenchments were due to economic problems and also because of the recent modernisation of the mill.

Worker, Mr Charles Ramsamy told the Mercury that the company should have informed workers last year when it decided to modernise the mill.

'We have not been told of the retrenchments but have heard through the grapevine,' he said.

Mr Glyn Taylor, managing director of C G Smith Sugar, said the company had entered into discussions with the union representing the workers regarding retrenchments.

'I cannot say at this stage how many workers will be dismissed or when they would have to go,' he said.

3/8/85

3-Sugar

Sugarmech 85 Mercury 6 Cyls New tractors cut fuel bills

3-Sugar

A FULL season of transporting cane at Sezela and Illovo has proved the efficiency of special haulage tractors. The new 12-speed models introduced by the C G Smith Sugar group have reduced by one-sixth the fuel used per ton of cane harvested.

The company, which last season produced almost a million tons of sugar, purchased 45 of the new Massey Ferguson haulage tractors (HTs) in early 1984. They were put into action alongside existing eight-speed tractors and by the end of the 1984/85 season had hauled 700 000 tons of cane.

Sezela estate chose the 51 kW MF 275 HT, but Illovo Estate opted for the model 290 HT which is rated at 58 kW.

On trailers

The cane was either transported loose in seven-ton box trailers or in bundles on side-loading trailers. Sezela's 19 MF 275's used just five litres of diesel per hour com-

pared with the six litres per hour of 16 other tractors on the estate.

The output of the two groups of tractors was similar at 13.0 and 12.9 tons per hour respectively, in spite of the MF tractors being less powerful than the others.

Sezela's technical field manager, Peter Braithwaite, said the improved fuel efficiency of the new haulage tractors had saved some R20 000 worth of diesel in their first season.

Our conventional tractors used 20 percent more fuel than the Massey Ferguson's for virtually the same amount of work. The MF 275s, being about R5 000 cheaper than the next tractor size upwards, were in effect more productive than their stablemates. In fact, we saved R100 000 at Sezela by going for the less powerful but equally productive model 275,' said Mr Braithwaite.

Encouraging

In 1983 the eight Sezela sections harvested 415 278 tons of cane and used 237 703 litres of fuel to move it from the field to the zones (1,74 tons per litre).

The following year (1984) when just over

half the tractor fleet was 12-speed Massey Ferguson's, the crop was 562 379 tons and the fuel used totalled 216 944 litres (2,59 tons per litre).

Peter Braithwaite says that these are encouraging figures, but they are 'sensitive' to the quality of the crop — 1984 was a good year and the heavy cane more readily transported.

At Smith Sugar's Illovo estate almost all the cane is transported to the zones in seven-ton box trailers.

Eleven of the 15 haulage tractors are the new MF 290 HTs and in 1984 the estate averaged 17.2 tons per hour compared with 15.1 the previous season. The better crop, trailer changes and other factors will have contributed to the improvement, in addition to the efficiency of the new MF tractors.

Fleet reduced

Illovo has, for example, improved overall efficiency so much that it has reduced its tractor fleet from 24 in 1977 to 15 in 1984, while the harvest rose from 186 000 tons to 267 000 tons over the same period.

Robin Campbell, agri-

cultural manager at Illovo, said he remembers when cane was hauled at an average of six tons per hour.

'Today it is transported at up to 20 tons per hour. Our agricultural engineers produced evidence and put forward proposals, Massey Ferguson did their homework and came up with the right gearbox in the right tractor — and now we are reaping the rewards.'

Malcolm Hatley, a qualified agricultural engineer, said driver response was very favourable to the new MF tractors.

The men quickly discovered the ease and speed of synchronesh gear changes.

At Sezela, section manager Nigel Hawley said haulage driving was a monotonous and tiring job. He and his drivers welcomed features that improved the working situation — such as the power steering on the MF haulage tractors, the easier gear changes, and the comfortable seat.

'We paint the drivers' names on the tractors. They take pride in their machines, and the MF men are envied by the others,' said Mr Hawley.

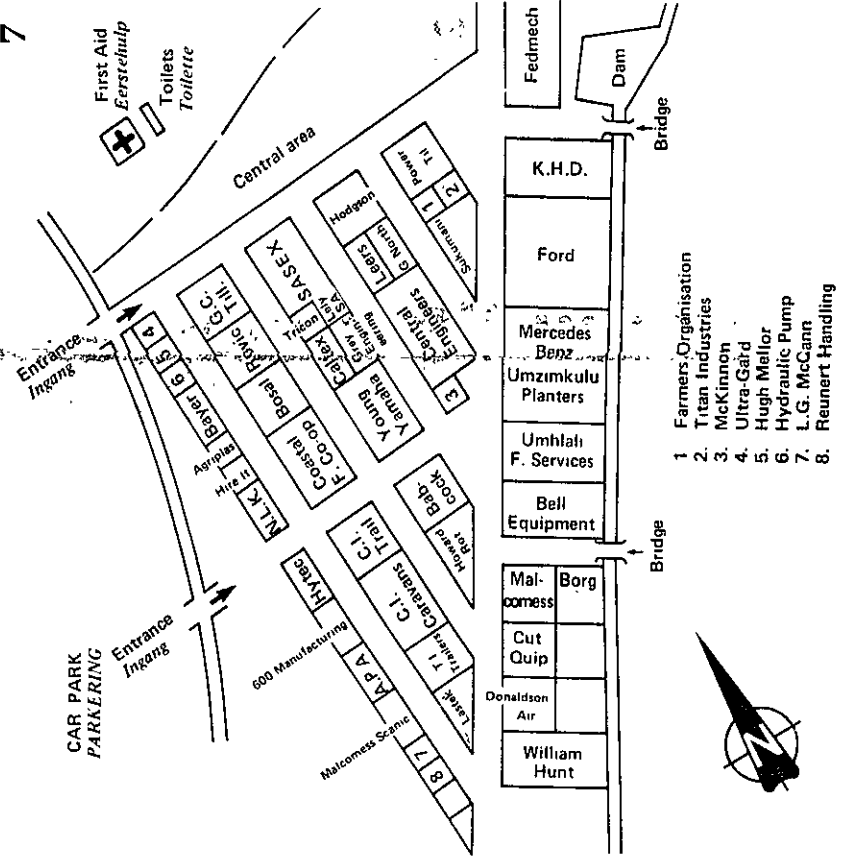
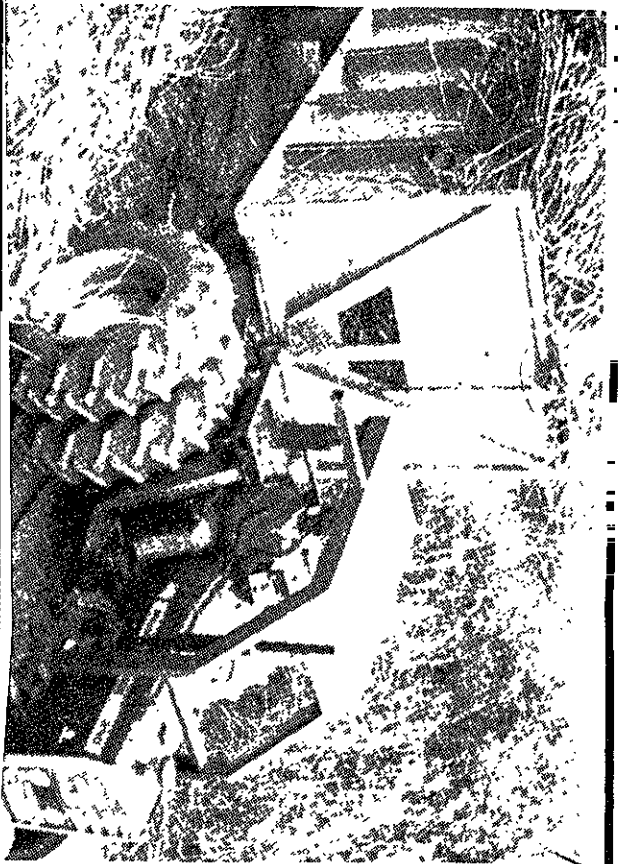

SASA Experiment Station

7

SUC

Sugarmech 85

Co-op's friendly service has paid dividends

3-Sugar

Mercury 6/8/55

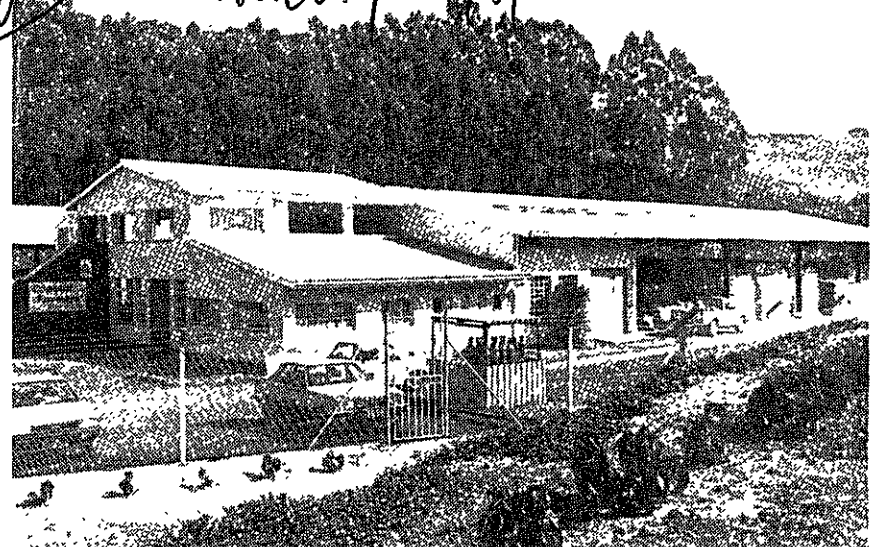

The Coastal Farmers' Co-operative is carrying out a programme of modernisation at all its branches. This is the ninth and newest branch opened recently at Umzinto.

IN THE 39 years that Coastal Farmers' Co-operative has been serving the farmers in the sugar industry the organisation has proved conclusively that bulk buying coupled with friendly service has paid dividends for its 1 100 members.

In 1946 when the co-operative was first formed the sugar industry was, like today, faced with crippling increases in production costs and it was realised by its 24 founder members that the only way to survive would be to use their combined buying power to bargain with suppliers and thereby obtain their goods at more competitive prices.

Coastal Farmers' first branch was opened at Compensation near Umhlali in response to a growing demand from that area for a fast, convenient and efficient source of fertiliser and an ever-expanding list of farm requirements. As membership expanded and farmers from other areas of the Natal sugar belt began to appreciate the benefits of the co-operative, additional branches were opened in Gingindlovu, Eshowe and Empangeni, followed by Stanger, Nseleni and Mtunzini. Two newer branches have recently opened at Mtubatuba and Umzinto.

Popular service

These nine branches have a combined fertiliser storage capacity approaching 20 000 tons. In addition to this facility each branch is stocked with agricultural chemicals and a general product range comprising some 500 different items. This range is constantly being increased to accommodate the needs of farmers.

One of the most popular services offered by the co-operative is its central buying department located at the Durban head office. Should members want any item of equipment not stocked at one of the branches, the buying department will obtain it for them.

The buyers are familiar with the co-operative's many suppliers and can normally obtain very competitive prices because of the co-operative's very considerable buying power.

The co-operative's chairman, Mr Neville Polkinghorne, speaking on the role to be played by agricultural co-operatives says: 'No farmer should use his co-operative unless that co-opera-

60 years' service to sugar industry

THIS year the South African Sugar Association's Experiment Station at Mount Edgecombe will have served the industry for 60 years.

The Experiment Station was established chiefly because there was an urgent need for new varieties of sugarcane to be introduced and because yields were declining.

It was also important that growers should have an organisation to which they could address their queries regarding cane growing.

Early in 1925, a 20 ha site was chosen on Natal Estates at Mount Edgecombe and later that year the institute came into being. At this stage, it consisted of a few sheds and tents in which the first farm manager, seven labourers, nine mules and a few implements were accommodated.

80 ha of land at Shaka's Kraal to accommodate the additional variety selection work that needed to be done.

The search for new varieties continued with the emphasis not only on finding those which produced higher yields, but also varieties which were suited to the range of soil and climatic conditions typical of the industry.

Soil study

The selection programme was aided by the acquisition of a farm at Pongola and another near Mount Edgecombe. Another boost to the programme was the construction of a large glasshouse which facilitated the production of new varieties.

The first study of soils in the sugar belt began in 1936 and was continued by Dr BE Beater when he was appointed

The recently refurbished laboratories contain some of the most sophisticated equipment used in agricultural research laboratories in South Africa.

The Extension Service was begun in 1954 with the appointment of two field advisory officers. As the Experiment Station grew so the need of more officers arose and today there are 17 extension officers located throughout the industry.

They provide a vital link between the Experiment Station and the growers and are the channel through which information and developments are disseminated throughout the Industry.

Valuable work

down from heaven. Those who have died believing in Christ will rise to life first; then we who are living at that time will be gathered up along with them in the clouds to meet the Lord in the air. And so we will always be with the Lord. So then encourage one another with these words. — (1 Thessalonians 4: 14-18)

on television and read about them in the news-ch, papers,' said the Prime Minister, estimating that 99.5 percent of Danes opposed the recent violence. 'We must talk about them with family and acquaintances and contribute to defending attitudes we thought were firmly established.' — (Sapp-AP)

things of the past and we in Natal would laughing all the way to prosperity. We could have Christopher Dingle on our negotiating team to keep the discussions lively. We, unlike the other provinces, do not have grain and bear it; we take our position seriously. It makes you think, doesn't it? N W MEYER Crown Point Prince Street Durban

Higher S A sucrose prices expected this season

8/8/85

Finance Editor

~~2/2/85~~
SOUTH African sucrose prices are expected to be up slightly this season, the chairman, Mr I F G Gillatt, of Crookes Brothers said at the annual meeting yesterday.

7 - Sugar
Provisional sucrose price for the guaranteed price A pool sugar will be R234,24 a ton while the B pool price will be R70,83 a ton plus R4,07 a ton for cane transport refunds.

Mercury
The A pool is expected to cover about 75 percent of the industry's production while the B pool will be sold, at the best price, on the export market.

Mr Gillatt expects that the average price for the group will be R232,28 a ton compared with R219,89 a ton for last season — an improvement of 5,6 percent.

The Swaziland price is expected to fall to R187,49 a ton from R213,44 last season.

Rain has fallen at Renishaw but not elsewhere on the company's properties and the drought remains. Normal spring rains, at the right time, should provide the estimated 378 000 tons of cane. With a higher-than-expected sucrose content this season any drop in cane volume should be offset.

Record prices are being achieved for citrus sales as a result of the rand's exchange rate drop and the industry is having a good 'quality' year, Mr Gillatt reported.

The downturn in the tourist industry has seen a 24 percent drop in expected attendance at the Crocworld complex at Scottburgh.

Mr Gillatt expected they would receive a dividend on their investment in Farm-Ag this year and that total dividend income would be higher than in 1984-5.

Sugar plans pleas on ethanol

Finance Editor

THE sugar industry—as a potential producer of ethanol to provide fuel for cars—does not feature in the draft White Paper on energy drafted by the government.

But the industry, with other energy-related concerns, can indicate its interest in ethanol production up to the end of September.

Yesterday, Mr Peter Sale, general manager of the S A Sugar Association confirmed that they would making a submission on the paper.

But the annual report of the Department of Mineral and Energy Affairs says that private sector interest in the production of fuel ethanol from agricultural products has declined to such an extent that no significant contribution from these sources is expected in the short term.

Low prices

However this report was written before the sugar industry in its recent round of industry meetings found that it needed to take up the sugar cane/ethanol issue with renewed vigour.

Low world sugar prices allied with a glut and gloomy prospects have induced the industry to see whether back-end distilleries at sugar mills could make ethanol profitably.

Umfolosi Co-Operative put their ethanol project on ice earlier this year when economic conditions, and interest rates, went the wrong way.

Next year the draft White Paper will be followed by a full White Paper and the First Energy Plan based on the draft and public comments.

The draft proposes a Central Energy Fund to be used for exploration and specific future energy products as well as energy research and the development of programmes which will be financed by a levy on all energy products.

Planning

Planning in 12 areas (synthetic fuels is one) will be on a long-term 15 year basis, revised every five years; and a short-term five-year plan 'revised biennially and adapted as necessary.'

The 12th area, 'energy survival and contingency plans', will not be published.

Longer range forecasts on the 'present predicted life of known indigenous mineral fuels, particularly coal, uranium, crude oil and natural gas', are to be made.

The White Paper comments on biomass (from maize or sugar-cane) may reveal government thinking on the use of sugar cane to produce ethanol: 'State assistance for the production of alternative fuels from biomass should be considered only during fuel crises because of capricious climatic conditions and potential shortages of food production. In those areas where expertise is lacking, the necessary research should be done in advance.'

Gas

But if South Africa wants to stand on its own feet, in respect of oil imports, government will have to take policy decisions to enable this to come about by its 1990 target when it will be more self-sufficient than now but the energy experts will not reveal figures.

There are many routes to be taken but most are expensive—witness the billions of rand spent on Sasol.

Private enterprise will have to be called in to fund such projects.

The Department of Mineral and Energy Affairs lists three promising routes which the private sector has proposed:

The conversion of natural gas obtained from the Soekor gas field about 100

km south of Mossel Bay. The gas will be changed to methanol and then to synthetic diesel and petrol.

By world standards the Soekor FA-EM field is medium-sized but has proven gas reserves of over one trillion cubic feet and an estimated 30 billion barrels of condensate.

FM-EM could produce, says Soekor, about 150m cubic feet a day equal to an output of 20 000 barrels of liquid fuel a day for 15 to 20 years.

Two private firms have been contracted to investigate and report on this prospect and a decision, according to the department, to proceed with commercial exploitation is expected by the year-end.

In the same area Soekor reported a drill hole earlier this year which yielded 2 600 bpd and one million cubic feet of gas a day—further exploration is needed to establish the size of this reserve.

Shale

Second project which would yield fuel is the distillation of oil shales, or torbanite. A private concern wants to exploit the shales which are found in the Transvaal Highveld coal field.

Anglovaal mined the torbanite shales from 1934 in the Ermelo district and refined them at Boksburg until the deposit was worked out.

They obtained the rights to the process which Sasol now uses to make petrol from coal but sold them to Sasol after the war.

There are oil-bearing shales of poor quality in the OFS, Northern Cape and at Impendhle in Natal while better quality shales are found in the Eastern Transvaal and Northern Natal.

Reserves are believed to be small and the deposits are mixed up with coal and other minerals making it difficult to mine and the seams are thin.

Coal

The third project is the indirect liquification of coal. A plant would convert coal to methanol which could then be mixed with a cetane improver and used in suitable modified diesel engines.

Or the methanol would be converted into synthetic petrol and diesel.

Says the department: 'The location of the coal-based project has not been finalised.'

The design has been completed for AECI's plant to convert methanol over a zeolite catalyst to ethylene and other hydrocarbons.

But says Gavin Relly, chairman of AECI, 'the effect of changed government protection policy and various other economic uncertainties have made it necessary to delay any decisions on the construction of the plant for the present.'

AECI has a 60 kl a day methanol plant, believed to be the only coal-based unit in the world, and there are plans to expand this to 2 700 tons of methanol daily.

Sasol is expected to reach full output of synthetic fuels 'shortly, thus reducing considerably the country's dependence on imported oil', says the department.

Forecasting Sasol Four it adds that 'the possibility that additional facilities may be built in future cannot be ruled out.'

Sasol uses over 33m tons of coal a year from its collieries to produce a vast range of chemicals.

Mozambique officials accept S A sugar plan

3/9/85
Finance Reporter
PROPOSALS recommended by Durban-based company Techserve to rehabilitate the Mozambican sugar industry have been accepted by Mozambican officials.

Research into the proposals, which were commissioned by Instituto

MOCIMBY
Nacinal do Aduca (INA), which is responsible for light industry and food for the sugar industry in Mozambique, required a survey of Mozambique's six sugar factories and recommendations for process of the 1985 crop and general rebuilding of its agricultural

operations.

3 - Sugar
The project, which will cost R11m, is being financed by an IDC credit of R8m with R1,65m paid in cash by INA and a UK credit of R1,35m.

Techserve started the project in February this year with a staff of some 50 engineers, supervisors

and artisans. The first factory rehabilitation has been completed and started crushing at the end of July.

Mr Geoff Walsh, managing director of Techserve, said yesterday, the project when completed will more than double Mozambique's sugar production this year and enable them to meet its premium priced US sugar quota worth some R30m.

He said the project entailed enormous logistical problems which required provisioning of personnel by air as well as shipping thousands of tons of material through Maputo, Beira and Chinde. Much of the material has to be carried by barge from the ports of entry to the factories and the project includes a R2,5m rehabilitation of the Zambezi River barge fleet.

Techserve will provide technical advisory and operational management services to the Mozambique sugar industry for a further period of three years.

Fate of sugar industry

Melmoth farmers decide today

Rodney Hayter

THE FATE of the sugar industry in the rich northern Natal area of Melmoth, which has hung in the balance since introduction of the Rorich Commission findings, will be determined today when cane farmers decide whether to buy the Entumeni Mill.

Farmers now have to pay for their own cartage to the mill and as a result, sugar farming in Eshowe, Nkwaleni, Melmoth, Heatonville and Ntumeni is becoming unprofitable because of recent fuel increases and large distances to the mills.

Representations were made to the Government for a new mill or for farmers to be allowed to transfer their quotas.

At a report-back meeting last week the farmers were told by Mr J Stevenson, who has spearheaded the campaign, that while Government permission had not been given for a new mill, they had released farmers from their quota commitment to other mills.

Deadline

He added that during these negotiations, Premier Milling, owners of Entumeni mill, had offered to sell them the mill, but required a decision by September 23.

The narrow deadline has been viewed with apprehension by many of the farmers, who have seen railage costs of sugar soar by nearly 60 percent in the past year,

but realisation is also strong among them that a local mill is their only real lifeline if they are to continue in sugar.

Mr Stevenson pointed out that further concessions by the Government — approval of further development of 300 000 tons of sugar-cane being grown in KwaZulu — coupled to Melmoth's present 'free-floating' 400 000 tons in the area and Entumeni Mill's present commitment of 350 000 tons, meant that the area could support the mill profitably.

The cost of the mill was not disclosed, but farmers were told an approximate R1,50-a-ton above normal costs during the next five years would pay for the mill, which by that time would have a residual value of about R3m.

Licence

The mill has a current annual throughput of about 350 000 tons of cane and while Premier Milling have refused to discuss the sale, or even acknowledge that it is for sale, acquisition by the farmers would give them automatic licence to continuing milling at Entumeni or build on another site.

The sugar industry is presently facing serious economic problems, but as Mr Stevenson pointed out last week, purchase of the Entumeni mill meant that the future of the local sugar industry was in their own hands.

3-Sugar
19/9/85 Mercury

W
U
t
o
r
i
n
V
S

n
h
c

Glendale mill has peak sugar tonnage

Finance Editor

3-Sugar
DEVELOPMENTS in the sugar industry, allied with pressure from the KwaZulu Government for further sugar areas can only 'augur well for the future of Glendale's sugar mill'.

Mercury
 Reporting in the Lonsugar annual report the mill says that after the disastrous drought last season the cane throughput increased this year and a record 47 000 tons of sugar were made. *19/9/85*

However, the low sugar price, high interest rates combined with the 'lower-than-allowed' return to mills has meant a loss for the mill during the season.

The Glendale estate produced 88 55 tons of cane and the planters, 326 173 tons of cane — both records.

New cane transport rules and the multiple pool system are 'revolutionising the industry.'

'One inevitable consequence of the new transport system will be its rationalisation and a re-distribution of cane supply to the different mills.'

The report said Glendale's present crop is proceeding very satisfactorily, which, with lower interest rates and better world sugar prices, will 'help to restore profitability.'

Commenting on the Swaziland operation at Big Bend, the report notes that the railway line to Maputo is unreliable, 'due to frequent attacks by dissidents in Mozambique.'

'Since the beginning of the season interruptions of traffic have been more frequent and additional storage space and even alternate routing are being contemplated.'

The Malawian sugar mill has been facing the same sort of problem as when the rail route to Nacala was closed last December leaving no other direct route.

The alternative rail routes are more costly and as a result sugar stocks have been increasing.

Melmoth cane farmers will not buy sugar mill

Mercury
Finance Reporter

SUGAR cane farmers in the Melmoth area have abandoned the plan spearheaded by sugar farmer, Mr J E P Stevenson, to buy the Entumeni Sugar Mill and run it as a co-operative.

Instead, Hulett's Sugar has offered to pay some of the farmers an extra R5 a ton for their cane.

They will buy 400 000 tons of cane from farmers in the Melmoth area it was learnt yesterday, but no Hulett Sugar spokesman was available to confirm this new arrangement.

The farmers were given until Monday to decide whether to buy the Entumeni sugar mill from the Premier Holdings group.

Transport

The mill is to the south of their area.

But yesterday Mr Stevenson said he had not given up his idea of 'doing something' for the farmers who were hard hit by the changes in the sugar cane transport scheme.

Farmers now have to pay for transport and this has hit those farmers living furthest from sugar mills.

Mr Stevenson, who has led the campaign since the withdrawal of transport subsidies has left cane largely unprofitable in the area because of the long distances to other mills, said the Hulett move meant total production from the areas other growers was now inadequate to justify their own mill.

Hulett's move follows an announcement last week that Premier were prepared to sell the mill to the farmers and that

the Government had released the growers from their quota to supply certain mills and had given approval for another 300 000 tons of sugar cane being grown in KwaZulu.

This additional cane added to Entumeni's present 350 000 tons and Melmoth's 400 000 tons of free-floating cane, Mr Stevenson said, would make the mill profitable.

Hulett's own the Amatikulu Mill and the new R180m Felixton II Mill.

Mr Stevenson said if farmers in the Eshowe, Nkwaleni, Melmoth, Heatonville and Entumeni channelled their quotas through Entumeni, the loss of throughput at the Hulett mills could be about R5m.

Mr Stevenson said he believed the terms offered by Hulett's were worth about an extra R5 a ton to the Melmoth growers.

Output

He was disappointed by the move because it meant that one of the most consistent cane production areas in the industry was now basically marginal for sugar cane because of the high transport costs.

It is also unfortunate about opportunities and the maintenance of jobs in the area. We as a group are very concerned to promote a stable environment in Natal-Kwazulu. An attitude of co-operation would have been far more fitting in this present economic recession.

However, we will continue to do what is logical and correct for the inhabitants of this area.

P

i
l
t
t
a
i
l
a
k
e
M
t
n

Future undecided for some N Natal cane farmers

Rodney Hayter

WHILE the new season's cane crop soaks up the early spring rains in the Nkwaleni Valley, the future in sugar for many farmers remains just as undecided since their plan to buy the Entumeni Mill became yesterday's dream.

A discreet silence is being kept by the farmers from the Eshowe-Nkwaleni-Melmoth-Heatonville and Entumeni areas, but sources within the industry indicate the last word has not yet been said.

Last week the farmers turned down an offer to buy the Entumeni Mill from the Premier Group, when Huletts — owners of the areas two mills — made some of the farmers a better deal.

Melmoth

The deal, addressed only to the Melmoth farmers within the group, is believed to offer them a 40 percent share of milling profits that could eventually be worth about R5 a ton.

Terms of the offer have not been made known and the discreet curtain of silence maintained by both parties suggests minute legal attention is being given to the offer which is likely to require the approval of the Sugar Industries Central Board.

Chairman of the Central Board, Mr P P Noppe, said yesterday he had no comment and this was echoed by Mr Peter Sale,

general manager of the South African Sugar Association, who said that apart from newspaper reports, he had no knowledge of the offer.

If the farmers had bought Entumeni loss of throughput at Amatikulu and Felixton would have cost Huletts about R5m annually.

Felixton

Such a loss, and coming soon after the commissioning of the R189m Felixton mill, could be a particular burden to a company currently competing on an over-supplied world market with a commodity at its lowest price in real terms.

Additionally, the exceptional high interest rates and the ravages from drought, eldana and hurricanes are still being felt in the industry.

Praise for Felixton for its milling capabilities has been offset by criticism from some growers, particularly in Melmoth, who claim the coastal siting of the mill, in light of subsequent developments emanating from the Rorich commission, was unrealistic.

Huletts claim the area is the 'centre of gravity' for suppliers and because of their commitment to the Mondi Paper Mill near to the mill.

The secretary of the Kwazulu Canegrowers' Association, Mr Geoffrey Bhengu, expressed mixed feelings yesterday at the group's failure to secure

the mill. 11/10/85
He said over 1300 KwaZulu growers in his Association with a total annual output of 106 000 tons were totally dependent on continued milling at Entumeni.

'If the group had purchased the mill and rebuilt in Nkwaleni the extra distance could destroy the profitability of the sugar industry in Entumeni, because of the extra distance to the new site,' he said.

Aid for the farmer to transport his crop to the mill is not allowed for distances over 40 km.

'We did support the group's request for a mill, but only for a new mill, not to resite the Entumeni at Nkwaleni. A relocation would destroy many jobs for which sugar offers the chance of employment.

Confusion

He said Entumeni mill was still for sale, but because of the active disinvestment campaign many companies overseas were reluctant to buy it.

The future for many of the growers in the area remains confused, but whatever the outcome of the Huletts offer, cane for which the area is particularly suited, could be a thing of the past.

Some believe a switch to other crops like lumber, could be the answer, but generally the feeling is strong to stay with a crop that is generally considered one of the best quality among fellow world producers.

White, Indian farmers to fight consolidation

3-Sugar Mercury Reporter

MORE than 300 Indian and white sugar farmers met in Inanda, near Verulam, yesterday and vowed to fight the KwaZulu consolidation proposals in their present form.

7/10/85
The meeting condemned the proposals and decided to send a memorandum to the commission, which sits on October 18, and to the Chief Minister of KwaZulu, Chief Mangosutho Buthelezi, calling on him to reject the proposals.

According to the proposals, more than 4 000 ha of Indian-owned land and four white-owned farms near Verulam would be affected in the Inanda area by the consolidation.

Mr Pat Bodasingh, president of the Natal Indian Canegrowers' Association, and his vice-chairman, Mr Yellan Chinsamy, told affected farmers they could not see the proposals implemented.

They promised to help farmers to fight to the bitter end because the livelihood of more than 300 farmers and several hundred workers would be affected.

Mr Chinsamy said there were more than 6 000 Indians in Inanda and the land was worth more than R20 million.

The meeting also lashed out at the Natal Agricultural Union for welcoming the new proposals.

'This white union which does not accept Indian membership has welcomed the proposals without knowing how it will affect Indians,' said Mr Chinsamy.

He told farmers he had had talks with Chief Buthelezi and had assured him he was against any consolidation.

Rajbansi

challenged
to halt land
takeover

Mercury Reporter

INDIAN farmers who stand to lose more than 4 000 ha of prime land at Inanda, Tongaat and Port Shepstone have challenged Mr Amichand Rajbansi, chairman of the Ministers' Council in the House of Delegates, to stop the incorporation of their land into KwaZulu

Following a weekend meeting of affected farmers at Inanda the Natal Indian Canegrowers' Association also called on Mr Rajbansi to show his teeth and prevent the takeover.

Mr Rajbansi said he could not comment on the challenge, but added that he was prepared to meet affected farmers and the association to discuss their plight.

Real test

Association vice president, Mr Yellan Chinsamy, said it would be a real test to see how powerful the House of Delegates was in protecting Indian-owned land.

'Mr Rajbansi must not confuse lower Inanda with the land proposed for incorporation into KwaZulu,' said Mr Chinsamy, adding that Indians had agreed to hand over their land in lower Inanda, but were against moving out of upper Inanda, near Verulam.

Mr Chinsamy said farmers near Hambanathi in Tongaat were also opposed to handing over their land for incorporation into KwaZulu.

Low rand saves sugar

Sugar *S. Tribune* *20/10/85*

Exchange rate and rise in world price saves SA industry from disaster

By MIKE PEIRSON, Finance Editor

THE sugar industry has been saved from disaster this year by the low rand exchange rate and a recent rise in the world sugar price.

The drop in the value of South Africa's currency, which has more than halved in the past year, coupled with a significant increase in the world price in the past three months, has alleviated what would have been a disastrous financial position.

This is the opinion of John Chance, who heads the South African Sugar Association delegation to the International Sugar Organisation.

He said in Durban this week: "Without that, we would have been totally in the cart."

Only three months ago, the London daily price stood at \$82 a ton. Since then it has risen by 56 percent to an average of \$128 a ton, and has been as high as \$140 a ton.

"The low exchange rate of the rand, with the recent world price increases, undoubtedly have stopped our industry from getting into very serious trouble."

In addition, he said, the major restructuring that had been carried out within the South African sugar industry was having the desired effect. Although the industry was going through a bad time, this was as much a result of the two disastrous droughts as it was of low prices.

There were hints from London this week that discussions on a new round of International Sugar Agreement talks could be on the cards.

For the past 18 months, there has been a stalemate on the question.

"The executive director (William Miller) put up a paper to the last ISO executive committee meeting in London for the first time, banging

False dawn will usher in darker economy

Finance Correspondent

WARNING has been sounded that the moves to push the economy into a recovery will create a premature "false dawn" next year that will fade and darken into a relapse.

The caution comes from researchers at Econometrica, the Johannesburg think-tank whose forecasts to business have an impressive record of accuracy.

They say the rand, on current performance on

exchange rates, will slide further next year and tumble to four rand to the dollar inside the next three years — shrinking to 33 United States cents in 1987 and to just 25 US cents in 1988.

Over the same period, the official inflation rate — as measured by the consumer price index compiled by Central Statistical Services — threatens to increase to 19,4 percent.

The analysis is certain to cause a furor among economists, businessmen and politicians alike, all of

as members of the so-called Group of Six would be bound to be brought in once the talks were enlarged.

The Group of Six was a powerful body that could influence decisions. Mr Chance said the European Commission was "really sweating at the moment" because some of the European Economic Community's losses on exports were supposed to be funded by levies on their quota sugar.

But they have run out of money. The commission has had to put in hundreds of millions of dollars to try to maintain

whom are divided over the course South Africa should follow to pull out of recession.

However, the Economic team sticks to the argument that: "There are already preliminary signs that an attempt by the authorities to reflate the economy could generate an artificial mini-boom during 1986 and possibly the first half of 1987."

"The authorities and various analysts mistakenly believe that the improvement in the balance of payments and a decline in

the export price for sugar, and this is really hurting."

He thought that in any future discussions, if the EREC, which had been a stumbling block in the last round of talks, tried to reopen proposals for the type of agreement based on complicated mechanisms that it had wanted last year, no one would be prepared to go to Geneva.

Australia, too, had been intransigent over what had become known as Cuba's special arrangement for sales to Comcon (socialist) countries.

Most of the other pro-

ducers had been more pragmatic. They had realised that Cuba's production was limited and could not be expanded indefinitely because the country was an island.

The world sugar community could live with reasonable restraints on Cuba.

"So until the Austrians also come round to some rapprochement and agreement with the Cubans, no one is going to go to Geneva as it will just be a waste of time," Mr Chance said.

"However, my own view is that, possibly by the middle of next year,

the interest rate are good economic pointers for a healthy recovery.

"However, these analysts overlook that, as a result of stagflation, the real economy has collapsed."

Econometrica is especially concerned over the possible pace of increases in exchange spending that could push M1 growth no less than 40 percent higher than the forecast horizon.

"The present softening in the interest rate structure will contribute to mild real economic growth,

things might start happening."

How would a new agreement affect the price?

Mr Chance believed that if it was announced there was to be a new negotiating conference, in Geneva, the immediate effect would be a drop in the futures price over the next few months. The reason was that countries which were holding large stocks would try to get rid of these before the beginning of a new agreement that would limit their exports.

However, in the months further into the agreement, prices would rise.

28/10/85 Mercury

Sugar mill to diversify

MBABANE—Swaziland's largest sugar mill, Simunye Sugar Company, has signed a R3 million loan agreement with the International Finance Corporation to diversify the company's farming operations

The loans will enable the company to develop a crop diversification scheme which began early this month and will produce 720 ha of cotton and 360 ha of dry beans on a rotation basis.

The general manager, Mr John Ranger, said that the diversification to cotton and dry beans would not affect the company's sugar production of about 125 000 tons annually.

Mr Ranger said continuing world-wide low sugar prices did not permit the expansion of its present sugar production. He said the new crops to be introduced would enable the mill to utilise its

resources of land, water and management personnel to the best advantage.

The cotton would supply cotton lint to the National Textile Corporation at Matsapa near Manzini. He said there were also ready markets both in Swaziland and outside for dry beans — (Sapa)

3-Sugar

NEW YORK WORLD SUGAR PRICE

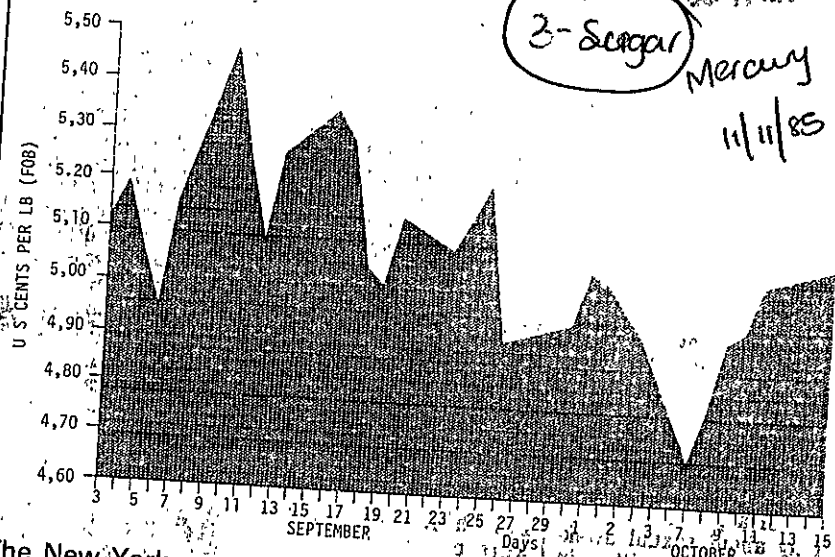

3-Sugar
Mercury
11/11/85

The New York sugar price, in U S cents per pound, is depicted on this graph from the S A Sugar Association.

... (misconstrued) ...

Sugar perks up, but farmers still worried

DUNCAN COLLINGS
Argus Correspondent

JOHANNESBURG. — Thanks to the weak rand, a better international market and a good local crop, South Africa's sugar farmers are more sanguine about the future than they were six months ago.

According to South African Sugar Association general manager Mr Peter Sale, if the current status quo remains the industry expects to generate sufficient income this season to cover its cost of production.

However, he points out that once again there will be no return on capital employed by the industry nor will it be able to reduce its indebtedness — currently standing at R327 million.

But he added: "Although few farmers are beaming, the frowns are not as deep as they were six months ago."

OTHER CROPS

Mr Sale said it was too early to judge the success of the new two-tier marketing system which was introduced at the beginning of this season and which was designed to ultimately reduce the number of hectares under cane in the country by eliminating high-cost growing areas.

He pointed out that cane was an 8-10 year cycle crop and it was uneconomic for farmers to take good cane out of the ground.

"It will only be when the new planting cycle returns that farmers will really be able to assess whether they remain in cane or look to other crops."

However, the outlook for the international market was much better than it had been and current estimates were that in the 1985-86 world season demand would outstrip supply for the first time in about five years with a commensurate small decline in the historically high world stock position.

As a result of this expectation the world sugar price had been improving. From a lowest ever price in real terms of 2,6 US cents a pound recorded in June this year the price had recovered to its current 5,7c a pound. "We now anticipate a gradual further improvement."

EXPORTS

The weakness of the rand was also helping the country's exports and in rand terms income from exports had improved significantly this year.

Also, the current crop — milling would end in December/January — was virtually unchanged from last year's good crop.

"The world price, the weak rand and the good crop give us much more hope for the future."

However, things were not as rosy on the local front where the depressed economy had resulted in estimated local offtake this year declining by about 70 000 tons to around the 1,2 million-ton mark.

At this level of domestic offtake there would be about 1 million tons available for export which was going to the country's traditional markets of Japan, Canada, Korea, the US and Israel.

Sugar production depends on further good rainfalls

4/12/85 BUS. DAY Industrial Reporter

(3) SUGAR

THE latest estimates from the sugar industry put the 1985/86 sugar tonnage at about 2,18-million tons, compared with actual production of 2,3-million tons in 1984/85.

Says SA Sugar Association GM Peter Sale: "The industry will probably face dry conditions this season after the record 1984/85 crop, which was boosted by heavy rain."

Natal, the main cane-growing province, received heavy rains recently, which reduced fears of a drought.

The industry's proceeds in recent years have totalled about R700m a year, apart from the bumper 1984/85 crop with its record R1bn.

Recessive conditions and the effects of unrest have had an adverse effect on local consumption — which constitutes about 60% of total sugar production — but the industry expects population growth to keep sales from dropping significantly.

The industry had also embarked on a marketing campaign, Sale added.

Political comment in this issue by Nigel Bruce. Newsbills by Tony Koenderman. Headlines and sub-editing by Michael Allwright. All of 171 Main Street, Johannesburg.

1985

3-Sugar

11/12/85

S A cane farmers end year R26 000 in red

Finance Reporter

SOUTH AFRICAN sugar farmers, already averaging debts of R260 000, will end the forthcoming season a further R26 000 in the red, in spite of the world price of sugar doubling in the last four months, a weaker rand and a greater world sugar consumption, according to Mr Tony Ardington, chairman of the S A Cane Growers' Association.

The reason, he says, is the extraordinary high interest rates.

Debts incurred by farmers as a result of two seasons of drought have left many farmers with huge liabilities that even a record crop of 2,3m tons last year has made little impact on reducing.

Since May, sucrose has risen from R68 a ton to R115 and is still rising, but Mr Ardington said these prices will not bring much relief to growers, many of whom were locked into rates considerably higher than prime overdraft rate, which is now 16,5 percent.

Growers

He said the gloomiest outlook was for growers who had built up big debts from the drought and others with slightly below average yields which represented about a third of the growers.

There are about 2 000 large growers — those that produce more than 150 tons of sucrose annually — and about 22 000 small growers.

Mr Ardington said the prospects for a good 1986/87 crop were bleak because from February this year the area had suffered its driest months in the region.

He forecast a crop of

2m tons unless there was very good rain in the next few months.

He said many farmers had undertaken their own transport costs as a result of the Rorich Commission, as there had been a much greater incentive for them to reduce their costs.

Most meaningful of these were the shortening of routes, optimum placing of transporting zones, elimination of uneconomic staging posts, increase in size of payloads, contraction of the industry in the areas of very long transport distances and scrapping of tramlines at old mills.

Savings

As a result, between R5m and R6m had been pared from the annual R100m transport bill and further savings could be expected when 'old' contracts with millers expired.

Mr Ardington said the introduction of the two-pool system had been beneficial in identifying marginal producers and marginal production areas because of soil type terrain and some had been forced into other crops such as cassava and timber, although he predicted a slow movement into wood.

Sugar farmers hold their own

BUS DAY

(3) SUGAR
ALAN PEAT

11/12/55

SUGAR farmers are holding their own despite the miserable economic climate, says Sugar Cane Growers' Association assistant GM Rex Hudson.

"Despite the problems they have faced, sugar farmers are in a reasonable state. There have been no cases of insolvency except where sugar farmers have dabbled in other commercial areas."

However, Hudson warns that drought, low world sugar prices, and high interest repayments are continuing to put pressure on farmers.

"The interest rate on bonds has not come down. It is all very well people saying that the banks have reduced their prime rate, but that has not got through to the farmers yet."

He says the Land Bank is giving deferment on repayment of its loans, and suggesting that farmers seek consolidation of their short-term debt and go for longer-term loans.

Hudson adds that sugar farmers are currently enjoying increased earnings from exports. Thanks to the exchange rate, exporters gain from the world market being priced in dollars.

"This is despite the low world sugar price," he says. "Our farmers are not hurting nearly so much as those in Australia, for example, where two sugar mills are possibly going to have to close because of their poor return from exports."

AGRICULTURE — OTHERS —

SUGAR — 1986

JAN. — DEC.

ETHANOL PRODUCTION

Ready to take off

(3) Sugar

A breakthrough on the controversial question of ethanol production from sugar cane as a fuel additive seems imminent. Thoughts of allowing some form of limited ethanol from sugar cane production in SA have been distilling in the minds of government and the industry for some time. Now, at last, it looks as if something is happening.

A number of factors appear to be acting in concert to make the ethanol option more appealing — or, at bottom, marginally more palatable to the major fuel companies who will inevitably have to move over to make room for the new entrant into the synfuel market.

First, there is government's own de-leading programme. From the beginning of this year fuel companies are required by law to reduce the lead content in fuel from 0,86 g/l to 0,6 g/l. Word is that a further reduction to 0,4 g/l is already in sight. Ethanol is widely regarded as a cheap and effective octane enhancer alternative to lead.

There is, too, a pressing need for the sugar industry to save jobs through diversification. Persistent low world prices have already resulted in a two-pool production system, the upshot of which can only mean more marginal land going out of cane.

Finally, from independent consultants comes the message that ethanol from sugar cane is indeed practicable — provided world sugar prices remain relatively low and the cost of traditional fuel inputs stays roughly constant.

Sugar industry sources are trying hard to suppress their enthusiasm — especially after the broad nod they received from government to press ahead with their feasibility studies and what seems to be a more flexible attitude on the part of the previously immovable fuel companies.

The SA Sugar Association (Sasa) has before it the report of its consultants, which broadly affirms its own views. It now has to take a firm policy decision on the ethanol issue. Given the size of the industry's debt burden and the grumbles over the low price of B-pool cane, it need not deliberate long.

According to a previous policy statement from the Energy Ministry, government is not offering ethanol producers any special marketing assistance, as it did for Sasol. But at the same time it is not being obstructive either — or the new initiative would not have been permitted.

If indeed the attitude of the fuel majors has mellowed, and this has yet to be tested, it might well have been prompted by a degree of enlightened self-interest. Ethanol, as the US experiment has demonstrated, is one of the cheapest ways of reducing lead in petrol.

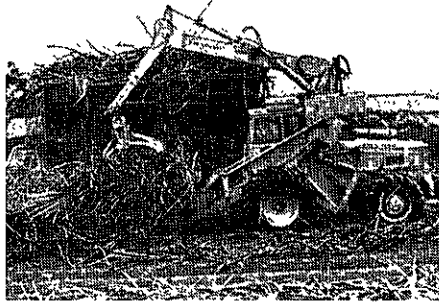

Sugar cane ... sweeter prospects ahead

By enforcing a 10% gasohol (ethanol) blend in its national fuel output, the US hopes to have 100% lead-free petrol by the end of this year. The country now consumes 25 billion litres of gasohol a year.

There are, of course, other options open to refiners faced with de-leading. Through further cracking in the refining process it is possible to produce more of the lighter fractions. But the process is expensive.

This does not imply that the fuel companies are going to give ethanol producers carte blanche. Hard bargaining can be expected when it comes to deciding market share and the price that blenders will pay for ethanol. Ethanol will probably be blended

first in Natal, but the producers have made it clear they will be expecting a price at least approximating the landed price of ordinary fuel.

Equally, Sasa has its problems. It has to decide whether it can afford to divert up to 15% of its production into ethanol on a sustained basis. With world sugar prices where they are (around £100/t) and working on a price per litre for ethanol equivalent to the current landed price of fuel, proceeds from ethanol should be greater than for cane processed into sugar.

But then sugar has been known to touch £400/t on the London market. If that situation were to arise again producers might be sorely tempted to divert ethanol cane back into sugar. No doubt the fuel companies will want assurances on that.

There is also the question of how the ethanol will be produced. Will it be through back-end distilleries attached to the mills and run independently by the sugar companies? Or would a single, industry-financed, continuous process distillery be preferable?

The consultants, the *FM* understands, favour the latter approach. It would certainly simplify matters if the division of proceeds and central marketing was handled by Sasa, as is done for sugar. It would also guarantee all sectors of the industry an equitable stake.

According to industry insiders, a central plant seems most likely. Several possible distillery sites have already been identified in the sugar producing heartland.

The spadework over, it now remains for Sasa to report back to government's Energy Policy Committee on the progress made and then, finally, face the major fuel companies across the table. That could well prove the most difficult hurdle yet. ■

LOOKING GOOD

The *Financial Mail's* circulation continues to grow, and the latest Audit Bureau of Circulation (ABC) figures highlight the magazine's six-month performance, despite generally declining circulation figures in the publishing industry.

Average sales of the *FM* in the six months to end-December climbed to 32 785, the highest six-month ABC figure in its history. The figure to the end of June was 30 843, an increase on the 28 493 in the period to December 1984.

The *FM* has grown 6,3% since the January-June 1985 period and 15,1% since July-December 1984, moving off an already high base. In the same period, *Finance Week* showed growth of 2,4% and 13,6% respectively.

The Afrikaans financial weekly, *Finansies & Tegniek*, had a circulation of 8 924, a 19,9% decline on the previous six months. *Business Day*, Saan's up-market daily, which was launched in mid-1985, established a daily circulation of 26 126 in the six months to December and continues to show solid gains.

AD AGENCIES

On their own

SA's advertising agencies and media owners — the SABC and the Newspaper Press Union — have agreed a new formula to guarantee agencies' debts in cases of default or collapse.

The move was initiated when the media demanded higher guarantees than those provided by the old Media Indemnity Company (MIC), which ensured that all the member agencies were responsible for a proportion of any debt up to R1m.

At the same time, the new formula means that agencies will only be responsible for their own debts and guarantees.

SUGAR PROSPECTS

FINAL
7/3/86

A mixed bag

3 SUGAR

South African sugar exporters must be in total confusion over the erratic performance of the world sugar price over the past few weeks.

As recently as three weeks ago, the South African Sugar Association's (Sasa) deputy director, Peter Norse, told the Agricultural Outlook conference in Pretoria that he expected the 1986-1987 season to be generally better than the previous one, with an anticipated higher average world price of US7c/lb.

He made that assumption on a reasonably solid basis. World sugar prices had climbed from a low of US2,7c/lb in May to a high

point of US5,59c/lb in December. The trend certainly looked firmer. But even as he was talking, the world price began to fall back. Now, more than ever, the future is unknown.

Says Sasa GM Peter Sale: "If you asked me now whether we still believed we would realise an average of US7c/lb for the season, there's no way I could give you an affirmative answer."

Norse's prediction that the average price for B pool cane would be R24,40/t, virtually double that of the previous season, is now equally circumspect. That estimate was based on a rand/dollar exchange rate of 43c. Since then, the rand has firmed to around 51c. A 20% variation in the exchange rate must inevitably mean a 20% variation in the price of B pool cane.

When it came to predicting the size of the local sugar crop he was, however, on much firmer ground. Good, if unseasonally late, summer rains should ensure a crop around 2,1 Mt. This would be a little below the previous season, but nowhere near the disastrous crops of the drought years of the early Eighties.

Coupled with that, there are some undeniably positive events taking place in the international sugar market. For the first time in many years, consumption is outstripping supply. By the end of the year, world stocks are expected to be in the order of 37,6 Mt,

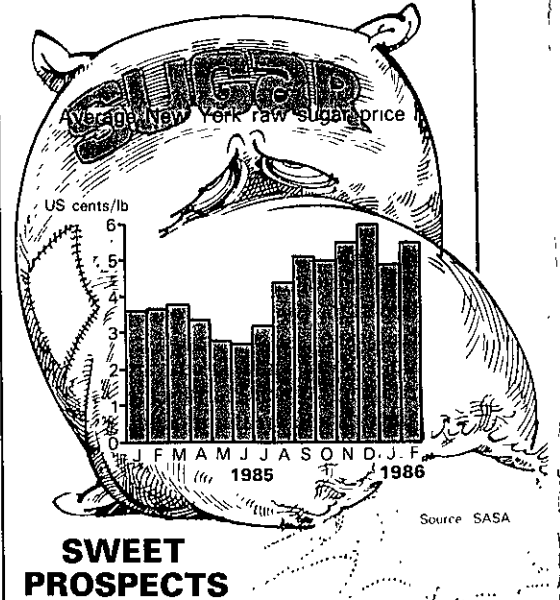

SWEET PROSPECTS

down from a high of 41 Mt.

As more large producers reduce their supply of sugar and consumption patterns hold, the trend is likely to continue until supply and demand is in finer balance. The stage may then be set for a long overdue rise in world sugar prices.

That, unfortunately, may be too late for

some hard pressed cane growers, exposed as they are to the vagaries of the international market. And there's certainly no guarantee that better times lie ahead, although some experts believe prices may have already turned the corner.

Under the circumstances, the industry has little option but to look to the domestic market for immediate price relief. Government has traditionally followed a policy of setting local sugar prices at least at a level equating to the cost of production.

If the same holds true this year, producers can expect an inflation-related price increase of some 16% before the season gets fully under way in April. ■

Outlook for sugar the best in years

bes times
3
9/3/86
Sugar

By Don Robertson

THE outlook for the sugar season ending on April 30 next year is better than for a long time. Higher SA and export prices are expected.

Early indications are that

production will be only marginally below this year's 2,3-million tons at about 2,1-million tons and will be worth about R1,2-billion.

The A and B pool system will be introduced from May this year. The A pool will handle all domestic demand and a part of exports, and the B pool will be based on an export price.

Projections are for a rise in A pool selling prices of 24,7% to R290 a ton from 232,53 in 1985-86 and for B pool by 73,9% from R109,20 a ton to R190.

Indications are that the export price of sugar will average US7c a pound, which will mean an increase of about 50% in earnings to more than R300-million.

R237m debt

Based on these forecasts, the industry faces an improved financial position and it is unlikely that the current debt of R327-million will increase.

However, the comparatively low export price is expected to result in about 10 000 hectares of B pool cane being lost to other cash crops. At present 410 000ha is under cane.

Exports are estimated at 800 000 tons for 1986-87, leaving a 40 000-ton surplus and boosting stocks to 190 000 tons.

Domestic sales are expected to rise 3,3% in 1986-87 to 1,25-million tons from 1,21-million tons of which 1,1-million will be white sugar.

The SA Sugar Association (SASA) has long-term plans to increase domestic consumption. At present, consumption is 37kg a head, but it is hoped to lift it to about 44kg in the next few years. But the market will have to grow faster than the average population growth rate of 2,5% a year.

Peter Norse, assistant general manager of SASA, says prospects for exports are more encouraging than at this time last year and consumption could exceed production.

It is expected that if supply and demand grow at 1985-86 levels, world stocks at the end of the year will fall to about 37,6-million tons. The stockpile would represent 37% of annual world consumption. It is accepted that when stocks reach about 25% of demand, supply and demand are in balance.

Of SA's exports, about 430 000 tons is supplied to America, Japan and Korea under contracts based on the free-market price. The rest is sold on the free market.

The SASA is seeking an increase in the domestic price.

Sugar price goes up

Mercury Reporter

CONSUMERS face another round of price increases following the announcement that the sugar price goes up by 13,5 percent today.

Housewives can expect to pay about R2,15 instead of around R1,89 for a 2,5 kg packet of white sugar, according to the managing director of Spar, Mr Brian Beavon.

'It's an absolute disgrace. Hundreds of items on supermarket shelves will be directly affected, not to mention fast foods, bakery items and cool

drinks,' said the general manager of Pick 'n Pay Hypermarket, Mr Martin Rosen.

'We will try to hold our prices for a few weeks if we can buy sugar which is already in the pipeline and therefore not affected by the announcement,' he said.

Mr Beavon said that Spar could probably hold out at existing prices for a maximum of four weeks.

'Food people have been trying to control inflation. It's time the manufacturers played their part,' he said.

Mercury 2/3/86

Rising sugar price a bitter pill for soft-drinks makers

By Frank Jeans

The soft-drink industry — the biggest buyer of sugar on the domestic market — is wincing under the continually rising cost of its prime commodity, a situation which the bottlers believe is aggravated by protective market mechanisms and a "ridiculous railage set-up".

The latest sugar price rise to R758 a ton in March pushed the soft-drink industry's annual bill for the commodity to about R75 million a year on a volume of 110 000 tons.

This is the bottlers' biggest raw material cost factor on which they get no rebates. They are said to have reached an impasse and are considering the use of high fructose corn syrup as an alternative sweetener.

The president of the South African Federation of Soft Drinks Manufacturers, Mr Hennie Viljoen, says his members are "up in arms" over the high price of sugar and argues against what he sees as "anomalies in the sugar marketing set-up".

He hits out at the Sugar Association for its imposition of a rail rate to be charged on all consignments from the Durban rail head at Rosburgh. "This spe-

cifically affects bottlers in the Transvaal.

"If a bottler in the Transvaal gets his sugar from 40 kms away, he still has to pay the Rosburgh railage."

The soft-drink men also run into obstacles on the avenues to cheaper sugar. In Swaziland, for instance, where sugar is currently priced at R514 a ton, its movement is controlled by a permit system which protects the local industry.

"This is a total monopolistic situation," say the bottlers.

The sugar industry, however, will counter with the argument that growers are having heavy losses on exports because of the low international price currently at £140 (R430) and despite a bumper crop of 2,3 million tons this year.

An aggravating factor is the sugar producers' debt burden which is now standing at about R327 million.

"Export losses should be absorbed by Government subsidy and not by the user," says Mr Viljoen.

"Notwithstanding the favourable exchange rate on exports the sugar price still went up by 15 percent."

Jakarta goes sour on visit by sugar experts

Own Correspondent

DURBAN — South African sugar technologists have been barred from the three-yearly congress of the International Society of Sugar Cane Technologists (ISSCT) because of apartheid and the political situation in the country.

The barring by the Indonesian Government is the first in the ISSCT's history. In the past South Africa has hosted even the Cubans, who hosted the 1983 congress which about 60 South Africans attended.

The Indonesians have also arbitrarily barred Israel from the congress in Jakarta in August.

The decision on South Africa was made final last week despite urgent representations by Britain, Australia, Brazil and West Germany.

The International Sugar Journal has written a hard-hitting editorial about the hypocrisy of the move, considering that other nations which have a far worse human rights record than South Africa are to attend.

Own Affairs:

HANSARD
20/5/86
ASKED THE MINISTER OF EDUCATION AND CULTURE:†

(1) (a) Which institutions for tertiary education which fall under his Department are covered by insurance policies in respect of (i) arson, (ii) riot damage and (iii) other specified risks and (b) in respect of what date is this information furnished;

(2) whether any of the risks of these institutions are underwritten by the State; if not, why not; if so, which (a) institutions and (b) risks?

THE MINISTER OF EDUCATION AND CULTURE:

(1) (a) (i) and (ii) Technikon OFS and Technikon RSA are fully insured. The University of Natal (in respect of their academic buildings), Technikon Natal, the Cape Technikon and Port Elizabeth Technikon are insured at 15% of the value of the property. The hostels of the University of Natal are insured at 50% of the value of the property,

(iii) the contents of the J S Gerike Library of the university of Stellenbosch and the motor vehicles of the following institutions are insured against political riot.

University of Pretoria
University of South Africa
University of Stellenbosch
University of Port Elizabeth
University of the Witwatersrand
Rhodes University
University van Natal
Port Elizabeth Technikon
Technikon Natal
Technikon Pretoria

(b) 15 May 1986;

(2) no. On 3 June 1981 and 13 December 1982 Treasury approved that applications from universities and technikon for a subsidised loan authority, concerning such cases as the damaging of university and technikon properties as a result of political riots, when it occurs, be considered according to merit, as an extraordinary contingency.

(a) and (b) fall away.

Note: The councils of universities and technikon are themselves responsible for the control and management of the institutions. Insurance cover of property and buildings belonging to these institutions, therefore, is their own responsibility. This includes cover against arson and riot damage. All the universities and technikon have the normal comprehensive insurance for, amongst other, floods, etc. Premiums for insurance against political riots are expensive. It was estimated in 1981 that the premiums for all the universities would amount to R1,0 million. The subsidy formula does not provide for funds for insurance against political riots.

TUESDAY, 20 MAY 1986

†Indicates translated version.

For oral reply:

General Affairs:
20/5/86
ASKED THE MINISTER OF TRADE AND INDUSTRY:†

(1) Whether international sugar prices firmed recently; if so, (a) to what extent and (b)(i) what is the current dollar price of sugar per ton on the

world market and (ii) in respect of what date is this information furnished;

(2) whether the price of locally produced sugar was increased recently to compensate for export losses; if so, (a) when and (b) what is this price per ton;

(3) whether he intends reducing the price of locally produced sugar; if so, when; if not, why not?

THE DEPUTY MINISTER OF TRADE AND INDUSTRY:

(1) Yes.

(a) The price of raw sugar has firmed on the London market from approximately 60 US dollar per ton (free on board) on 3 July 1985 to approximately 204 dollar per ton on 8 April 1986. Subsequently, the price declined again to 168 dollar per ton on 16 April 1986 and thereafter fluctuated around 180 dollar per ton.

(b) (i) 169 US dollar per ton on the London market.

(ii) 19 May 1986.

(2) No, not to compensate for export losses. Allegations which are made that the local consumer subsidises or has subsidised losses on export sugar are unfounded. This aspect received specific attention during a recent investigation into the sugar industry by an independent company of management consultants which did not find any indication of such alleged subsidisation. On the contrary, the investigation revealed that the sugar industry had subsidised the local consumer by a total amount of some R200 million during the period 1974 to 1985.

(a) and (b) The industrial price of sugar for local consumption was, in fact, increased in accordance with the existing norms to R758 per ton and

R698 per ton for refined (white) and unrefined (brown) sugar, respectively, on 21 March 1986. These norms apply only in respect of production for the local market. On 1 May 1985 an A and B-price and production pool system was introduced in terms of which production is divided into an A and B-pool. The A-pool is mainly for internal consumption while production under the B-pool is destined for export only and solely at the risk of the producers (growers and millers). During the past few years and since the introduction of the pool system the international price of sugar has been and still is at a level which is to such an extent below the production cost that several growers have ceased production for the B-pool.

(3) No. The price of sugar for the local consumer is determined on the basis of the production costs, which at present does not leave room for a price reduction. It may be added that the price paid by the local consumer is not influenced by the return on exports. As mentioned in the reply to Question No 2, the price obtained for export sugar is at the risk of the producers. These producers therefore bear any losses sustained on account of the changing and mostly low international price. Consequently, it is also only reasonable that the advantage attached to any rise in the international price of sugar will accrue to the producers.

Black training: money from USA/CGermany

*2. Mr L F STOFBERG asked the Minister of Education and Development Aid:†

(1) Whether he (a) has been informed of and/or (b) has investigated allegations that millions of rands voted by the Governments of the United States of America and Germany for Black training are administered by a certain body, the name of which has been furnished to the Minister's Department for the purposes of his

Smith Sugar looks set to return to profitability

21/5/86 SMR 128 35u91M

By Gareth Costa

The South African sugar industry is emerging from one of its worst periods of recession and CG Smith Sugar's prospects are looking healthier.

A drop in production and depressed world prices saw CG Smith Sugar's contribution to the group's results slightly down from last year, but group MD Mr Glyn Taylor sees sugar production of between 800 000 and 850 000 tons for the 1986/87 season, following late rains in March and April, in line with last season's figures.

The world sugar price has rocketed from a low of \$82 to \$222, with the rand/dollar ratio providing further gains to local suppliers, while internal sales picked up following a nation-wide promotion to wholesalers and chain stores during 1985.

The 1985/86 season featured several major setbacks in common with a period that has gone down in the sugar annals as the "sour eighties" in comparison to the "sweet seventies".

World sugar prices hit a low of \$82 towards the end of 1985 — its lowest ever in real terms — with production down and the long-awaited price increase not materialising until the end of the season.

For CG Smith Sugar, the relieving factor from the setbacks was an increase in recoveries — the ratio of sugar recovered per ton of cane crushed — which was better than the principal competitor's for the third year running.

On the chemical side, Smithchem and Natal Cane By-products (NCBP) came through strongly to support sugar, and Mr Taylor says: "The strong performance of Smithchem follows our R30 million expenditure programme on the furfural/furfrey alcohol plant which came on stream with few problems."

The weak rand also helped NCBP to achieve export orders for alcohol which would not otherwise have been attained.

The overall world picture is also favourable for SA sugar, although at the expense of others, as global consumption exceeds production for the first time in five years due to droughts, cyclones and the closure of mills around the world.

The only negative factor at this stage is the effects that the "sour eighties" have left.

"The interest on the massive loans the sugar industry had to incur to survive is some R50 million. A period of firmer prices must be used to

address the problem," says Mr Taylor.

CG Smith Foods expects an increase in earnings this year, and the board comments: "Economic conditions are unlikely to improve during the financial year, and certain of the subsidiaries are not expected to achieve the same high level of increased earnings for full year as in the period under review. CG Sugar is, however, anticipating improved export earnings."

Own Correspondent

MANUFACTURING ethanol for fuel in Natal would have far-reaching consequences, says Dr Brian Preen, who has produced a feasibility report for the SA Sugar Association.

His firm, Project Engineering Africa, was responsible for the design of the ethanol plant at Triangle in Zimbabwe.

Preen says there are three main considerations:

- Creation of 26 000 jobs;
- Replacement of tetra-ethyl lead as an octane increaser;
- A cost of only R10 000 for each new job created.

Preen does not know whether the sugar industry will go ahead.

(3) SUGAR

Ethanol study says 26 000 new jobs possible

"There are too many variables to consider. Tetra-ethyl lead is still cost-effective. We do not know what the long-term relationship between the rand and the dollar will be.

"Nor do we know how far the price of crude oil will fall."

"Above all, the oil and sugar industries will have to arrive at a consensus before marketing a blended fuel."

3 SUGAR

Rise in sugar price gives hard-pressed producers cause for cautious optimism

By David Axtell

LONDON — A rise in world sugar prices in recent months provides an encouraging backdrop for talks later this week between the world's four top exporters, struggling to find ways to put some backbone into the sugar market.

But the keynote of today's meeting between Australia, Brazil, Cuba and the European Community will be one of caution, diplomatic and trade sources said.

The International Sugar Agreement, which failed to support world prices, has withered into little more than a talking shop between key producing and consuming countries. Although dialogue between the main exporters is keeping hopes alive for a new pact with some economic muscle, past history has not been promising.

Previous negotiations collapsed two years ago and by last June average world sugar prices had dissolved to 2.78 cents a pound, their lowest since late 1969.

Current world sugar prices of around 7.5 cents a pound, though still less than the cost of production for most growers, offer exporters some hope that the worst days may be over. However, prospects of stabilising prices under a revitalised pact at more remunerative levels — say around 10 to 12 cents a pound — will quickly fade if producers are tempted to cash in on the recent price rise to expand their exports.

Fuelling the upturn has been an awareness that there will be less surplus sugar hanging over the market than earlier thought.

Sugar broker Mr G Czarnikow predicts that world production will trail well below consumption, both this year and next.

A forecast drop in Cuba's current crop, accompanied by compensatory purchases on the world market by its main customer, the Soviet Union, and strong demand from India, have helped nudge prices higher.

Fears that the Chernobyl disaster in the Ukraine might affect this season's

Soviet sugar harvest have also helped to strengthen world values.

But prices have already slipped below the peaks hit in March and April, which should signal to major exporters that an era of high prices and earnings is not about to blossom, sources said.

Partly due to the growing use of alternative sweeteners, developing nations now account for over half the imports of sugar from the world market.

These countries will be deterred by the higher prices from embarking on a major spending spree. In fact, barring significant crop setbacks there is no possibility of a world supply shortage, the sources said.

The exporters therefore have good reason to concentrate on artificial methods by which they might control prices.

Last February Brazil proposed a more flexible type of sugar accord than ever tried before, along the lines of the relatively successful International Coffee Agreement.

A global export quota would be es-

tablished each year and all exporters would be allocated a market share geared to their past export records. The size of the overall quota would be adjusted in line with the rise and fall of prices within an agreed band.

Such a system would get away from a feature of all sugar pacts since the 1950s which allowed growers a guaranteed export entitlement. Some analysts say this was their main defect.

But the sources said Australia, which exports three-quarters of its sugar output, is likely to oppose dropping the concept of a minimum export entitlement. In Queensland, which grows some 95 percent of the country's sugar, the crop still plays a large role in domestic politics, the sources said.

Nevertheless, the sources said, expectations of a closer balance between world supply and demand over the next 18 months or more, and prices which are gradually approaching healthier levels, could foster a better climate for negotiating a new pact. — Reuter.

23/5/81
Ethanol project on ice

THE goal posts for the sugar industry's ethanol project have been shifted in the past 18 months, SA Sugar Association chairman C van der Pol said yesterday.

He was commenting on the remarks of civil engineer Brian Preen, who has been commissioned by the association to undertake a feasibility study into ethanol production.

Preen estimates that 25 000 jobs could be stabilised or created if an ethanol project were to go ahead.

Van der Pol said that since the industry began a more serious look at ethanol about 18 months ago, the world sugar price had risen from 2,5 US cents to 8c a pound, while the crude oil price had slumped from \$25 to \$14 a barrel.

An ethanol project would cost about R60m, and once the industry had undertaken to provide ethanol for blending with petrol or diesel, it would be "locked in forever".

The supply of ethanol could then have a higher priority than sugar for the domestic market, Van der Pol said.

A positive factor had emerged recently in government's decision to reduce the lead content of petrol. However, ethanol was not the only route for the oil companies to maintain octane levels, which was now done by adding cheap tetra-ethyl lead.

Van der Pol described the change in the ethanol picture over the past year as dramatic and, as a consequence, it would not be possible to forecast the number of jobs which would be created or stabilised if, and when, the decision was taken to build an ethanol plant.

Political comment in this issue by Ken Owen. Newsbills by Neil Jacobsohn. Headlines and sub-editing by Gordon Amos. All of 171 Main Street, Johannesburg.

③ SUGAR BUDDY

World surplus will get smaller ... 2/25/86

Expert predicts sugar price high after slide now

AS WORLD sugar markets plummet, leading analysts are predicting a medium-term recovery which could exceed previous record highs.

The volatility of the market was highlighted last week when prices crumbled from \$209 to \$186,50 a ton — a drop of \$22,50, or 10,7%.

"As demand swings upwards and world surplus is depleted, we will see prices rocket," said one London broker.

Fears that market prices would affect local sugar production have also been discounted by SA Sugar Association GM Peter Soal.

Local producers braced themselves initially for cut-back announcements after last week's plunge.

"The latest drop will have no effect on SA production, as we depend on longer-term trends rather than short-term movements," Soal said.

"One can expect this sort of fall from a market which is traditionally volatile. Sugar is dominated by politics rather than by market forces.

"Look back to June 1985, when the market came from a low of \$82 to a record \$222 a ton. Sharp ups and downs are typical."

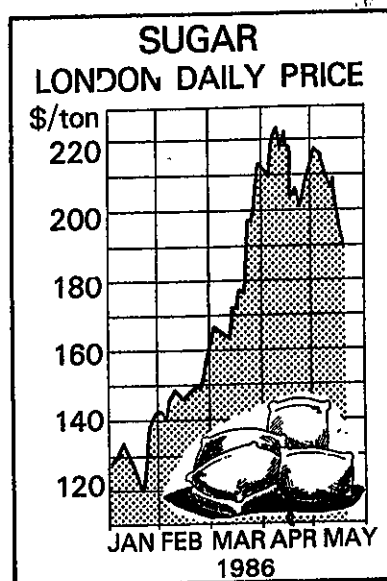

MICK COLLINS

Soal said the latest market dip had been offset partially by the falling rand. "Sugar markets are traded in dollars. With the rand/dollar exchange rate now standing at US\$0,44, earnings won't be hard hit. This is fortuitous for producers and will serve to counteract the slide."

finance and investors' preference for shorter stock. One broker expresses surprise that Escom had to provide an option. "I would have thought it could raise R100m more easily," he says.

The issue should be well subscribed. Escom is unlikely to take up more than R100m, though it plans to issue a total R1,6 billion in loans 163 and 165.

It also emerges that the Reserve Bank, acting on Treasury's behalf, has tapped the full amount (R1 billion) of its new 1989 stock. The Bank will thus have to move to some other stock for the rest of the year.

Dealers are "very anxious and uncertain" after SA's raid into neighbouring states. The long end was most affected. As the *FM* went to press on Tuesday, RSA 13% 2005 was trading at 17,18% compared with a Monday low of 16,87%; Escom 11% 2009 at 17,94% (17,56%); and Sats 7,5% 2008 at 17,5% (17,32%).

In the shorter end, both Escom and RSA medium-term stocks firmed in reaction to the raid, RSA 15,5% 1990 by 24 points to 15,31% from Monday's low and Escom 9,25% 1994 by 27 points to 16,53%.

The short end was hardly affected (see story headed "Money Market"). RSA 15% 1988 was unchanged since Monday at 13,3%. Dealers report that the keen institutional interest of two weeks ago slowed, even before the raid. ■

FIN MAIL 23/5/86
SUGAR (3) *SUGAR*

Turning sour

The fragility of recent high price levels was demonstrated last week by a heavy fall which resulted not from the appearance of any new bearish factor but simply from the absence of any fresh bullish influence. The gains of the past month were wiped out by a fall which left the London daily raw price (LDP) US\$22,50 lower on the week at \$186,50/t. Similar falls were registered on the futures market before values rallied a few dollars.

"After a long time in the doldrums, the market needs constant bullish news to keep it buoyant," explains Faraday Bromfield, head of research at ED & F Man, the London broking house. She says traders have been looking forward to an upturn in physical demand which has not materialised. Indian buying interest has reappeared from time to time, she notes, but has always been met by a flood of cheap offers.

The recent rise, which took the LDP to within \$5 of early April's two-and-a-half-year high, was largely due to concern over Soviet and Scandinavian crops following the Chernobyl disaster. But a subsequent lull in Soviet buying on the world market supported the view that the Ukrainian beet crop may not be as badly affected as thought at first.

At least one leading London broker, C Czarnikow, remains fairly bullish about medium-term prospects, however. Its latest review confirms an earlier forecast of a sub-

Not too sweet

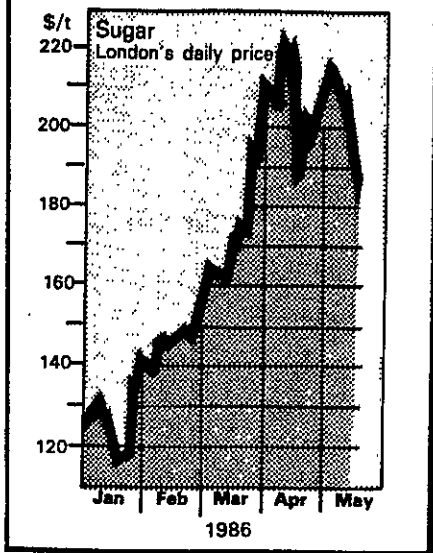

stantial reduction in world stocks over the next 18 months. For the 1985-1986 season it now puts world production at 96,74 Mt.

The review also concludes that the level of stocks in 1987 will be about the same as in 1979, just before the last boom — which lifted LDP to £410/t in 1980 — while world consumption will be some 12 Mt a year more than in 1979. "It would appear, therefore, that prices have the potential to move substantially higher over the next 18 months should any disruption of production occur," Czarnikow reasons.

Over at ED & F Man, however, Bromfield adopts a more conservative view, predicting a production/demand deficit this year around 2 Mt followed by 1,5 Mt-2 Mt the following season. ■

CANADA

Break in the bull?

To the extent that unanimity is possible, experts are bracing themselves for a break in the Toronto Stock Exchange's (TSE) record-breaking four-year bull market. Charles Winograd, senior vice-president for research and trading at Richardson Greenshields, a leading securities firm, sums up the mood: "The TSE could go a bit higher, but most individual stocks are pricey."

Many institutional investors have begun to lighten their equity portfolios and build up cash balances. Short sales are at record levels and put options (which protect holders from falls in share prices) have become increasingly popular.

David Williams, who oversees pension fund management for Beutel Goodman, a Toronto investment counselling company, observes that "the market is becoming fully valued." He argues that shares of medium-sized and small industrial companies, in particular, "are being given multiples which discount several years of very good earnings

ahead."

Why, then, does the market remain so buoyant? The TSE 300 Index broke new records on seven of the first 18 days in April, reaching an all-time high of 3 129 on April 18. By then, the market had risen by almost 8% since the beginning of the year. The climb would have been steeper but for falls of 22% in the oil and gas index and 19% in the pipelines sector.

Although the steam has gone out of the market in the past four weeks, it by no means gives the impression of being on the skids. The TSE 300 is still only 2% below the April 18 high. Both the supply of new issues and demand for them remain strong.

Despite their cautious views on near-term prospects, institutions have a lot of money to spend. Cash settlements in some of Canada's biggest takeover bids have put about seven billion Canadian dollars into investors' pockets.

In addition, securities firms' retail business is booming as small investors belatedly try to get a slice of the action.

Some sectors have benefited from a re-assessment of business prospects. Shares of forestry and paper companies have soared by 35% since the beginning of the year as lumber and pulp prices have improved.

Several forces which have driven North American markets upward in the last few years are still in evidence. Interest rates are sliding after a jump early this year to defend the weak Canadian dollar. Inflation remains around 4% and could go a little lower. With the notable exceptions of oil-rich Alberta and the prairie grain belt, the economy is expected to grow solidly both this year and next.

Cautious money managers argue, however, that share prices have already discounted this rosy outlook. PE multiples of broadcasting and publishing companies, which have been among this year's favourites, have risen from 18 and 19 respectively to 21 and 23 this year. Yields on many are now below 2%. Only another unexpectedly sharp drop in interest rates or some other dramatic — and unforeseen — news seem to justify another significant further advance in these shares' prices. But the timing and extent of a setback remain a mystery.

Optimists already talk of a revival before the end of the year. Basing his arguments on lower interest rates and oil prices and stronger economic growth, McLeod Young Weir's head of research, John Pepperell, predicts that the TSE index could bounce back to 3 300 or 3 400 by next January. ■

MORE GILTS

In view of the increased interest in this sector of the market, the *FM* this week expands its coverage of major gilt stock yields. The enlarged table can be found on page 75.

clining trend, but it is now highly sensitive to resurgence from injudicious social and political policies for which government has a poor reputation.

So SA fails the first Sprinkel macro-economic requirement for growth: general price stability. Nor does it score well on the second, the limitation of economic shocks; or the third, adequate control over the level of government spending. Clearly, if Pretoria goes ahead with a stimulatory package based primarily on increased government spending, it will deliberately be flying in the face of experience elsewhere.

Constraints on growth

Its professed belief in supply-side measures, which include privatisation, will face reducing credibility and further depress business sentiment. Another constraint on economic growth in SA is the enormous cost of financing homeland and "independent" governments and the policy of industrial decentralisation.

These governments are effectively being given and often misusing what amounts to large foreign aid payments. This is an enormous impost on the South African taxpayer

and, as the perceived need for this type of black development grows, the amounts involved are likely to grow substantially. They show every indication of having the same deleterious effect as the West's foreign aid to the Third World, which the British economist, Lord Bauer, of the London School of Economics, criticised with devastating precision.

He told delegates at Saint Gallen that this mistaken transfer of wealth was going to the rulers of the Third World countries and not to their impoverished subjects, thus rewarding profligacy and increasing general impoverishment. He said it neither addressed adequately the relief of need, nor had it encouraged development. It did not get to the poor, as there was no machinery for State relief of poverty in Asia or Africa. It was dissipated on lavish spending and rising politicisation. It impaired international competitiveness in Third World economies and led to increasing pauperisation, he said.

"The misery in Ethiopia has been brought to the notice of tens of millions of people in the West. But not many know that the government of Ethiopia has regularly received large-scale Western aid. This totalled US\$1

billion over the five years 1978 to 1982. Throughout this period, the government pursued most of the damaging and destructive policies listed above, including the forcible transfer of people, persecution of productive groups, coercive collectivisation of agriculture, confiscation of property and underpayment of farmers by State buying agencies," he said.

Correct solution

According to Bauer, the volume and cost of investible funds are not critical for economic development. If they were, millions of very poor people would not have risen from poverty to riches in a few years or decades, as has happened the world over. "To have money is the result of economic achievement, not its precondition," he said.

If what Bauer says is correct, then it is not simply money or decentralisation that will develop the homeland and "independent" states. The solution, as with economic growth in SA, is not through the public purse but through supply-side incentives and the freedom of people to respond to them. That is why the Group Areas Act is a major impediment to growth. ■

THE SUGAR INDUSTRY

The options of upturn

FINMAIL
20/5/86

③ SUGAR
1986

A year ago sugar farmers were in despair. Low international prices coupled with several devastating droughts had put the industry in hock up to its eyebrows. Worst of all, there seemed to be no recovery in sight.

Last season, for the third successive year, the industry's proceeds were barely sufficient to cover costs, and growers and millers had to once again forgo their return on capital. That led sugar men to seriously question whether they would ever earn the right to call themselves sugar barons again.

Consumers, meanwhile, braced themselves for what they knew was to come. Precedents of the past had taught them that when the industry took a beating in international markets they, invariably, were called on to make good at home. So there was the prospect of having to once again dig deeper into their pockets to raise domestic sugar prices to a level that would ensure the industry remained afloat.

True to form, government announced another domestic price increase of 15% in March, and the industry took comfort in the thought that even if the international market was bad, at least they would cover costs on the domestic side. The recent rally in international sugar prices has, however, given a fresh perspective on matters.

Although it is obviously too early to say with any certainty that a new bull run has started, SA Sugar Association (SASA) GM, Peter Sale, predicts the industry could well end the 1986-1987 season with a "modest"

The world recovery in sugar prices has brought some confidence back to local sugar farmers. But with major debts overhanging the industry — and the unlikelihood of attracting further loans abroad — the chances of SA's consumers getting a lower sugar price are not all that good.

surplus, allowing members to at least recover a portion of their normal return on capital.

Better still, if the revenues are there, the

industry might be in a position to divert some of the surplus into reducing the size of its loans, which have stood at around R327m for the past three years. Interest on the debt alone is costing the industry around R50m a year.

Feeling optimistic, seasoned sugar men are even talking of the day when the industrial loans may be liquidated entirely and further surpluses channelled into building up a healthy stabilisation fund — a luxury the industry has not fully enjoyed since the mid-Seventies.

However, are they reading more than they should into the recent sugar price surge on

the London market? Sugar prices are notoriously cyclic: they have been known to hit US\$598/t in times of temporary shortages. The last time sugar traded at these levels was in the late Seventies.

Sale shies away from suggesting that the markets are about to see a repeat performance of those heady levels; but he has recently returned from London and the message he brought back from brokers is



SASA's Sale ... confident of a steady price rise

Own Correspondent

PRICE increases obtained by the sugar industry from March 21 saw refined sugar rise to R758 a ton (white) and R698 a ton (brown).

But this price is still below the current level brought about by cost rises, says the Cane Growers' Association's annual report.

Included in the report is a dossier from the Florich Committee which shows that in the last season A pool sucrose sold for R236 a ton while the discretionary B pool was R103. The A pool has been cut by a further

3 SAC ML

Sugar pool system is grieved with interest

4.46% from March to bring it to a total of 1.8-million tons.

The report says the pool system has been grieved with interest abroad as it removes the need for industrial subsidies and external financing.

To counter decreased consumption as prices rise the industry has in-

creased spending on promotions.

World consumption has risen by 10-million tons since 1980 but output and stocks have risen to leave a stockpile of 38% of consumption.

Increased use of the commodity was stimulated by low world prices which reached an all-time low of 2.5 US cents

a pound, last June (about \$11.60 a ton) but it is now nearer to \$200 a ton.

Prospects for a world sugar agreement which would act as a cartel to maintain prices were at a preliminary stage with a Brazilian concept from last year being discussed.

The industry is now looking at best possible times for cane harvesting and the report says, there is a need for mills to improve their cane reception, shorten their season and pay for a higher quality cane.

Talks have begun on the equipment mills would need to finish the season by December 23.

Brighter outlook for cane-growers

Own Correspondent

DURBAN — A brighter short to medium-term outlook was outlined by the chairman of the SA Cane Growers Association, Mr Tony Ardington, yesterday.

Although he stressed, in his annual address, that there were sombre notes and pitfalls facing the domestic market, he said there also were hopes that the drought cycle and grasp of the destructive eldana borer on the industry had been broken.

The association's annual report shows that at the end of the first full-season of the two-pool system, 1985/6 A pool sugar production was 1,86 million tons — over the projected 1,8 million tons. As a result, all A pool quota allocations had to be reduced by 4,46 percent with effect from May 1, 1986.

The report says the reduction "should not prejudice growers" because the reduced A pool will

attract a higher price.

The significant difference between A pool and B pool sucrose prices (R236 and R103 respectively) had naturally stimulated demand for A pool quotas.

Mr Ardington said potential returns from ethanol production were still better than those currently earned from exporting sugar, despite the fall in oil and rise in sugar prices and the serious drop in the rand.

Added to this, there were good reasons for believing that very high sugar prices of the past were less likely in the future. "I suspect that much of the new import demand by developing countries which have low incomes per capita and severe foreign exchange constraints will fall away in the face of a rapid rise in price."

In general, he said, the industry still stood bloodied and debt-ridden — but more efficient,

"leaner and poised to reap the advantages that will flow from steadily improving fundamentals in the world sugar market and the short-term competitive edge which the weak rand had given us".

The much larger debt burden and higher interest charges — coupled with previously very low prices — had squeezed further economies from the growing section. These economies had been achieved at a price. Farmers "strapped for cash" had cut back on their planting and fertiliser and deferred maintenance and capital expenditure.

However, improved revenues, which hopefully would accrue to growers this season, should be used to replenish those resources undermined during the lean years.

Growers would continue to press for an equitable system of

cane payments, "coupled with compensatory disciplines for changes in the length of milling seasons".

There was widespread recognition of the serious diseconomies related to harvesting in the months of January and February.

Mr Ardington said the major pitfall was that the domestic market was "in jeopardy" with hardly a day passing without some violent deaths. Major investors lacked the confidence to make new investments and therefore prospects for robust economic growth were dismal.

The country faced a rising sea of unemployed. "Those unemployed people are our customers ... our market."

Until the country could look forward to a reasonably stable socio-political environment, the domestic market would remain insecure.

INDUSTRY

~~3~~ 3 Sugar

Sugar price slump leaves a sour taste for industry

SPECULATOR selling and a lack of physical trade have resulted in the gradual weakening of price levels in sugar markets.

However, brokers believe the 1987 outlook remains sound because of a projected overall improvement of 2.7% in consumption figures.

Frans Oosthuizen, national marketing manager of the SA Sugar Association (Sasa) says that in the direct sales sector, consumers have been affected by unemployment and are consequently going for smaller pack sizes.

"But the general consensus is that consumption will increase steadily, slightly ahead of the population growth rate," he adds.

Current per capita consumption is about 37kg a year and is expected to stabilise at between 38kg and 40kg.

"Growth will come from the lower income groups as buying power is increased," Oosthuizen says.

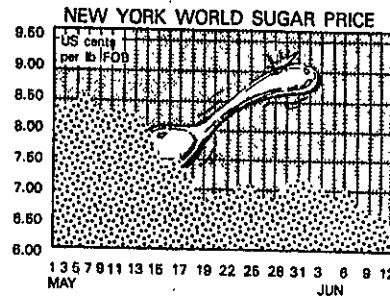

MICK COLLINS

"In the higher income groups, consumption per capita is expected to decline with the trend towards slimming and dieting and the growing availability of alternative sweeteners."

Direct sales presently account for 72% of the market.

The industrial sector accounts for the remaining 28%, but long-term

forecasts indicate a swing towards this sector as a result of prepared foods.

"Growth in sales in this sector have been retarded by the recession which has affected sales to industry more than direct sales," Oosthuizen says.

Industrial users have also been hit by a sugar price rise earlier this year.

"Any price increase has a negative effect on the industrial user because of increased input costs.

"He also has to try and maintain selling price for as long as possible in order not to lose volume and market share," Oosthuizen says.

He says Sasa appreciates the problem and its policy is to increase sugar prices only in relation to increased production costs.

He does not foresee industrial users moving to high fructose corn syrup since sugar remains far cheaper and the sugar/maize price does not favour local production at present.



Tongaat's profits decline

BUSINESS (3) SUGAR

24/6/86

THE consequences of diversification into recession-prone industries can be seen from Tongaat-Hulett's experience last year.

All group divisions — with the lone exception of the starch and sweeteners division — suffered a decline in profitability. Two divisions, textiles and industries, ran up a loss at the pre-interest level.

Chairman Chris Saunders said in the annual report the group's policy was to concentrate on food, clothing and shelter activities, and in the light of that, considerable rationalisation was undertaken during the year.

The group's timber plantations, engineering and electronic operations were sold and the total workforce was reduced to 37 282 from 43 265. Several food division operations were either closed down or sold, realising R29m in cash.

The benefits of the rationalisation

STEPHEN ROGERS

are expected to come through this year, but the industries division is unlikely to revert to profitability.

The sugar division, with a turnover of R457,9m (R440,6m) and pre-interest profit of R51,7m (R52,6m), was again the mainstay of the group. The excess world sugar consumption over production has resulted in an improved export price which should auger well this year.

In the building materials division turnover and pre-interest profits slumped to R277,8m (R336,8m) and R6,7m (26,2m) respectively.

Demand levels have reached their lowest levels since 1978 — with the division operating at less than 60% capacity for most of the year — and nine factories were closed resulting in a reduction of workforce to 10 625 from 12 386.

Declining total sales in the aluminium division were partially off-set by higher export sales but total sales volumes for the year declined and pre-interest profits dropped to R12,2m from R13,1m.

Gearing has been reduced to 66% from 71%. But last year's interest bill — in a period of falling rates — rose slightly to R103m (R100m), aggravating the decrease in interest cover to a low 1,4 (1,7) times and the return on capital employed to 7,7% (9,3%).

The share rose to a 12-month high of 845c — on expectations of a better second-half and an improved world sugar price — before settling back to 730c.

Saunders said earnings this year would be significantly higher than last year. However, they have a long way to go before they reach the post-merger peak of 118,5c a share in the 1984 financial year.

Sweeter year for sugar

Industrial Staff

PROSPECTS for the sugar industry, were better than they had been for years, SA Sugar Millers' Association (Sasma) chairman Frank Jones said yesterday.

He told Sasma's annual meeting in Durban: "The first signs of a long-awaited recovery in the world price of sugar are evident, with the quotation for October 1986 standing at \$156 a ton. And for the first time in five years, consumption is expected to exceed production, and by a sizeable margin."

That was due to production cut-backs in countries such as Brazil and Argentina and to climatic problems in the Dominican Re-

public, Cuba and Australia.

Jones said despite continuing high inflation, the sugar industry expected to earn some return on capital this year as a result of better export prices.

Calling the 1985/86 season "a disappointing one in many respects", Jones said total production of 2,11-million tons was well below the early estimate for the season and 250 000 tons below the previous year's output.

That was due to drought conditions which were particularly severe in Zululand and on the North Coast.

Sasa bid
3-sugar
to woo
26/6/86
health freaks

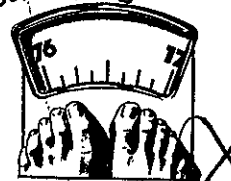

MICK COLLINS

FEAR of obesity and a consumer yearning for the svelte, wraith-like figure of the Eighties, continue to pose a major threat to the sugar industry.

To combat growing slimming trends, the SA Sugar Association (Sasa) has launched a massive publicity campaign in a bid to sweeten a health-conscious market.

National marketing manager Frans Oosthuizen says misconceptions about sugar and health are costing the industry dearly.

"Current per capita consumption is just short of 37kg a year. This is expected to stabilise at between 38kg and 40kg, which is lower than most Western countries," he says.

"In the UK, per capita consumption stabilised as high as 45kg before gradually declining as a result of slimming and dieting trends."

With the trend already becoming apparent in SA's higher income group, Sasa has become more aggressive in its defence of sugar, says Oosthuizen.

"There is now sufficient scientific evidence to prove that sugar is a safe product and has a role to play in today's diet."

"Although sugar is a factor in tooth decay, there is no evidence to show that it causes diabetes, heart disease or many of the other ailments which it has been blamed for in the past."

Sasa is sponsoring scientific nutritional research and stipulates that recipients of grants may submit their findings for publication in medical journals without the prior approval of the association.

"We have appointed a scientific advisory panel to screen applications for research grants and advise on research projects."

Oosthuizen says most of Sasa's public relations drive is now centred on presenting a balanced view of sugar as a natural source of energy.

Education projects on nutrition and health are targeted at a variety of audiences — including school-children, nurses and patients in clinics, nutritionists, dieticians and women's groups.

Sasa has also established an advisory service run by a nutritionist.

A schools programme has been implemented in Soweto and the East Rand and preparations have been made for the launch of a clinics programme.

The association also plans to send a quarterly newsletter to doctors, dentists, nutritionists, dieticians and home economists.

"Our aim is to position sugar as a natural product which has a role to play in our daily diet. We are determined to get rid of misconceptions about sugar and health," says Oosthuizen.

Own Correspondent

DURBAN — The sugar industry now faces brighter prospects after a disappointing 1985/6 season, Mr Frank Jones, retiring chairman of the SA Sugar Millers Association, said.

Mr Jones said at the association's annual meeting that first signs were evident of the long-awaited recovery in the world price of sugar — and the current season's prospects for the industry were better than in previous years.

The quotation for October sugar currently stands at a more healthy £156 a ton and, for the first time in five years, consumption is expected to exceed production. The excess will be a sizeable margin owing to production cut-backs in several countries.

As a result the local sugar industry expects to earn some return on capital from its exports this year — despite continuing inflation.

Mr Jones said the 1985/6 season had been disappointing in many respects. Total production of 2,11 million tons of sugar had been well below early estimates and a quarter of a million tons below the previous year's output.

He attributed the fall to

Brighter prospects for sugar farmers

26/6/86
(3) SUGAR STRIKER

drought conditions (especially in Zululand and on the North Coast) and eldana infestation. The eldana problem could again affect the crop in the current season.

Although the 1985/6 cane crop of nearly 19 million tons of cane was 19 percent down on the previous year, the industry obtained an above-average sucrose content.

Coupled with low fibre, this gave a good cane-to-sugar ratio of 8,8 percent for the season.

The mills set an overall extraction record but boiling house recoveries had fallen owing to lower juice purities. Operating efficiencies reached a peak and, overall, the industry had received good reports on its efficiency and productivity gains.

On the domestic market, recession, unemployment and boycotts had pushed sales marginally below those of the previous year. However, sales of 1,23 million had exceeded estimates.

The past season's biggest disappointment was the world price of sugar which reached a record low (in real terms) of £82 per ton.

Export earnings were low. Despite the higher domestic price, total proceeds from the sale of all sugar and molasses improved only 4,4 percent to R1 062 billion.

Industry requirements, by contrast, amounted to R1 279 billion (R1 145 billion for the A pool and R134 million for the B pool).

The resulting R217 million deficit had to be absorbed by millers and growers — the largest ever experienced.

This was the third successive season in which the industry had failed to earn any return on capital.



Frank Jones

COMMODITIES

Notes 24/6/86 (3 Sugar)

Prospects brighten for Natal sugar industry

PROSPECTS are brightening for the Natal sugar industry, says the chairman of the SA Sugar Millers' Association, Mr F R Jones.

He said the export sugar price, which slumped last year to a low of \$82 a ton, was now \$156 a ton for October deliveries. This year, for the first time since 1982-83, the industry expected to earn some return on capital.

Sugar production in 1985-86 was 2,1-million tons, 250 000 tons less than in the previous season.

A total of 1,2-million tons were sold in the domestic market, which was marginally below last year's figure.

However, lower export earnings resulted in industry sales rising only 4,4 percent to R1,06-billion, causing a deficit of R217-million.

INTE

FIN MAIL 27/6/86

SUGAR INDUSTRY (3) SUGAR

Moving to profits

The speculation is over. Higher average sugar export prices and a recent domestic price increase means the sugar industry is almost certain to end the season with a modest surplus over costs (FM May 30).

Barring unforeseen circumstances, such as a calamitous slump in world sugar prices, SA Cane Growers' Association chairman Tony Ardington says growers should return to profitability for the first time in years. This means they are likely to make the first payments towards redemption of the industry's accumulated R327m debt.

With uncertainties over SA's political future in the international banking climate and the difficulties local clients experience in securing new offshore loans, clearing the industry's debt has become the major priority. Interest on the debt alone is costing the sugar industry a crippling R50m a year.

Both growing and milling sectors have agreed on a formula under which they will be obliged to direct a percentage of future surpluses towards loan repayments.

SA Sugar Association officials declined to divulge details of the arrangement to the FM, saying that as "nothing was set in concrete" the figures were subject to change.

Sugar prices on the international market have softened in the last few weeks to around US6,2c/lb after topping 9c/lb in April. However, brokers generally attributed the fall to the market looking for new direction after heavy speculation. They confidently expect prices to see out the year at about 9,5c/lb.

If that is the case, and given an average crop size of about 2 Mt, the industry is likely to see total proceeds for the 1986-1987 season top R1 billion while fixed and variable costs remain marginally lower, leaving a small surplus.

On the local front, Ardington says the changes in the cane transport system which place the cost of cane transport on the grower and the new multiple pool system have resulted in increased efficiencies.

A study by the National Productivity Institute has shown that the industry increased

its productivity by 4% per annum over the past four years, resulting in annual savings of around R40m.

In addition, Ardington says growers are keen to move away from the concept of pricing cane in accordance with its sucrose content. A new price formula, based on the estimated recoverable sugar with built-in credits for by-products, has been devised.

The issue is, however, controversial as some millers could end up paying more for their cane inputs

while others pay less, depending on the quality of the cane and the time it is harvested.

Ardington argues: "If growers are bearing their full costs of production, it's only

fair that they should receive a price that equates to the full value of their product."

Although he admits there is likely to be some hard bargaining before the new pricing system is accepted, he would like to see it introduced within two years as a further means of improving industry efficiency. ■

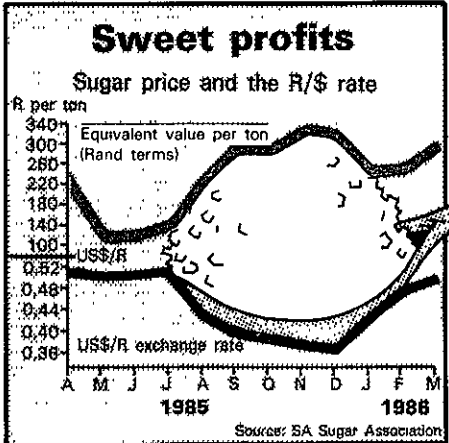

Molasses storage in Cape

Bussell 16/1/70 (3) Sugar

Own Correspondent

A DURBAN company is establishing a tank-storage depot for large quantities of molasses in Cape Town docks to meet an increasing demand, particularly by stockfeed mills — it in the Western Cape,

Fleming Schiodt, of Pure Cane Molasses in Durban, has been appointed GM of a new subsidiary to be known as Cape Tank Terminal.

He is to take charge of the expanding molasses operation at the Cape from September.

He said yesterday that three large tanks being erected near the Sturrock drydock would have a capacity for 6 000 tons of molasses. Two other tanks would be able to hold 1 000 tons of other bulk liquids.

Schiodt said that where molasses had been transported to the Western Cape mostly by rail, it would in future be shipped in coasters from Durban, and pumped into the new storage tanks.

There was an annual consumption of about 20 000 tons of molasses in the Western Cape at present, and this intake was expected to rise appreciably in the next few years, he added.

17/7/85 BUS DAT (3) SUGAR

Sugar market stirring

FIRST signs of a long-awaited recovery in the world sugar price are evident with the quotation for October at \$156/ton.

This is a substantial improvement on last year's price.

SA Sugar Millers' Association chairman Frank Jones says a major factor for the local industry is the weak rand's swelling of export earnings.

"For the first time in five years world consumption is expected to exceed pro-

MICK COLLINS

duction by a sizeable margin."

This is due to production cuts in Brazil and Argentina and climatic misfortunes in Australia, Cuba and the Dominican Republic.

"Prospects for the current season are better than for some years despite continuing high inflation which is playing havoc with production costs."

Sugar bosses to 'take sides on power-sharing'

The Argus Correspondent
DURBAN. — The South African Sugar Association (Sasa) has taken a strong stand against apartheid and is to actively "take sides" on issues such as power-sharing.

At Sasa's annual meeting here yesterday the chairman,

Dr Kees van der Pol, said the association's anti-apartheid resolution should be regarded as the industry's declaration of intent to do what it could to create an equitable South African society.

"Traditionally Sasa has kept a low profile on political issues, but we can no longer remain silent, even though we have represented among members of our industry the entire political spectrum."

While not taking sides for or against the Government, Dr van der Pol said the association could not sit on the fence on major issues such as the abolition of apartheid, power-sharing on an equitable basis and the restoration of law and order.

"These issues affect our economy and indeed our very survival as a South African nation."

He said Sasa had a proud record of promoting black advancement. However, much had to be done.

"We must work towards the abolition of apartheid.

"The abolition of apartheid is not an end in itself to be achieved at any price — it is the means to bring about a just, peaceful and prosperous society in which we all can share."

Sugar body to 'take sides'

24/7/86
3 Sugar
Own Correspondent

DURBAN — The Sugar Association has taken a strong stand against apartheid and is to "take sides" on major issues.

At SASA's annual meeting in Durban yesterday, chairman Mr Kees van der Pol said: "This signals a break with our traditionally apolitical stance."

"We can no longer remain silent on issues such as the abolition of apartheid, power sharing on an equitable basis and the restoration of law and order."

He said SASA had a proud record of promoting black advancement with schemes such as the SASA Industrial Training Centre, the first multiracial centre of its kind in the country which initially operated in defiance of apartheid laws, and the Sugar Industry Trust Fund which has enabled thousands of underprivileged children to receive an education.

24/7/86

FCN M/VOL. (7/85)
 TONGAAT-HULETT (3) SUGAR

Spoonful of sugar

Activities: Holding company with interests in sugar, building materials, food, aluminium, textiles, starch and sweeteners and industries.

Control: Anglo American holds 20,0% and AMIC 23,5%.

Chairman: C J Saunders; managing director: T G Cleasby.

Capital structure: 73,5 m ords of R1. Market capitalisation: R543,9 m.

Share market: Price: 740c. Yields: 1,6% on dividend; 3,3% on earnings; PE ratio, 30,6; cover, 2,1. 12-month high, 845c; low, 580c. Trading volume last quarter, 810 000 shares.

Financial: Year to March 31.

	'83	'84	'85	'86
Debt:				
Short-term (Rm) ..	95,9	85,3	161,4	146,3
Long-term (Rm) ...	95,0	310,3	365,3	352,4
Debt:equity ratio	0,25	0,52	0,64	0,61
Shareholders' interest	0,64	0,52	0,50	0,50
Int & leasing cover ..	4,2	3,7	1,7	1,3
Debt cover	1,10	0,38	0,21	0,16

Performance:	'83	'84	'85	'86
Return on cap (%) ..	12,9	10,8	10,8	8,3
Turnover (Rm)	1284	1515	1804	1848
Pre-int profit (Rm) ...	150,3	158,7	175,7	136,0
Pre-int margin (%) ..	11,3	10,1	9,4	7,0
Taxed profit (Rm)	83,3	100,3	55,8	24,7
Earnings (c)	116,6	118,5	60,3	24,4
Dividends (c)	58	58	30	12
Net worth (c)	1206	942	1012	1035

Though year-end figures show EPS plummeted from 1984 to 1986, it seems Tongaat-Hulett has managed to achieve a turn-around — on a half-yearly basis, EPS of 40,1c for the six months to end-September

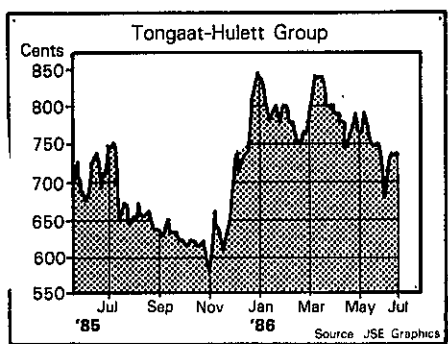
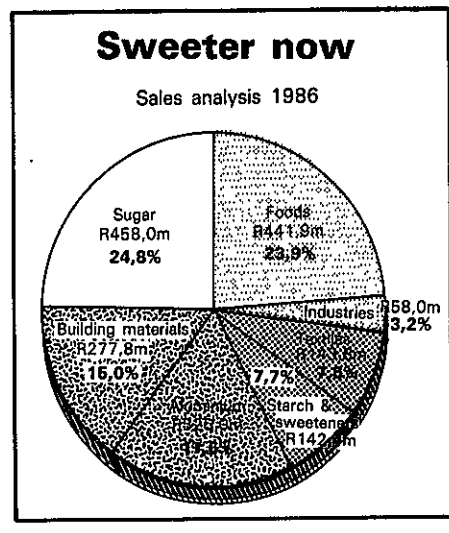

1984 fell to 4,9c by end-September 1985, but rose to 19,5c for the period to March this year.

A rigorous rationalisation was necessary to bring this about. In the past year, operations were sold, factories closed, divisions "rationalised" and since 1982 the payroll has been reduced by 10 665 people. This has cost R5m-R6m, and three or four factories may never be opened again, according to financial director Ted Garner. The main benefits will only be seen in 1987.

Sugar has again become the most important sector. Its profit contribution was 41,6% in 1985 but 51,8% in 1986; though sugar's profits fell 1,8% to R52m, production dropped 27,5% and the cane:sugar ratio remained lower than that of the industry, as did the sucrose level.

Two major problem areas are building and textiles. Building materials' contribution crashed from 20,7% to 6,7% pre-interest, and capacity utilisation was under 60%. In addition, there are 320m bricks in stock. Textiles actually made a loss. The collapse of the denim market, in particular, caused a profit turnaround of R5,4m to a loss of R1,6m, despite breaking even in the second half.

During the rationalisation, new acquisitions were made in the food and aluminium sectors. The food business obtained R29m from the sale of operations, and invested in a ginnyery in Swaziland and a Cape mushroom farm, while the 24% shareholding held by Alcan of Canada was acquired by the aluminium division (whose profits have declined consistently since 1983).

Upturn is expected to gain momentum this year. Brokers' forecasts are for earnings of 75c-85c and the share price suggests that investors agree.

Obviously, an important factor will be the outlook for sugar, though Garner expects dependence upon sugar to be reduced. Profitability has improved in the local market, and the export market should provide the "cherry on the top," Garner says, with the world price up from £67/t a year ago to £97/t (rand equivalents are R169 and R382 respectively).

Aluminium should show a small improvement, while starch and sugars should maintain earnings, and the effect of the "major pruning" in the food division last year will be reflected in this year's figures.

While rationalisation benefits may keep flowing through, no solid recovery can be expected until management has resolved its

three main problems. Results need to be improved in building materials and textiles, and the heavy debt burden must be eased.

Building and textiles are expected to enjoy the benefits of last year's cuts. An eventual consolation is that the stockpile of bricks will enable the company to enjoy a "R30m improvement for doing nothing," if government's stimulatory package boosts demand; in the meantime the stocks are costly to hold. Expected improvements in demand for denim and increased export sales are also expected to move the textiles division into profit. Garner points out that any increase in volumes in Tongaat's high fixed-cost operations will benefit margins, which were halved in 1986.

He admits the key issue is debt. Borrowings were cut by R28m last year and this, combined with lower interest rates — borrowings of R400m have overdraft-related rates — pared the interest bill by R3,9m to R99m. Lower rates this year should reduce the interest bill by over 20%, and Garner believes government will not let interest rates "rise too high." But, though gearing does not look high, debt cover is low, and Garner anticipates that borrowings should be cut another 5% this year. He says there will be no rights issue.

It would seem the improvement will continue, with a little help from increased demand and higher sugar prices. But at a p/e ratio of 30,6 and a projected p/e of 9 based on average forecasts from brokers, the improvement looks fully discounted by the present price.

Pat Kenney

21/11/86 (3) Sugar

Business Mercury

Sugar industry holds loans down to R327m

Finance Reporter

FOR the fourth year running, members of the South African sugar industry have, on average, failed to earn any return on capital, Mr I G B Smeaton, vice-chairman of the South African Sugar Association, said yesterday.

The chairman of the S A Sugar Association, Dr Cees Van der Pol, talks with former chairman, Dr Anson Lloyd (centre) and vice chairman, Mr Ian Smeaton after the annual meeting yesterday.

He told the association's annual meeting that while proceeds were sufficient to cover costs of production of refiners, millers and growers they were not sufficient to provide any return on capital.

However, some consolation came from the fact that for the third year in succession it was not necessary to increase the loans raised by the industry, which remained unchanged at R327m.

Repayment

Mr Smeaton said that given a favourable world sugar price in the not too distant future it was possible a start would be made on repaying the loans

Emphasising the importance of the domestic market, Mr Smeaton said proceeds over the past five years had totalled just over R3 000m while total export income over the same period had not even reached R1 000m

The 1985/86 domestic market comprised some 57% of the industry's total production and gross proceeds of 77%.

He said that while the export market was important in providing a vital source of foreign exchange income and a buffer for production, it was the domestic market which provided the industry's 'bread and butter.'

Domestic

However the domestic market, because of high unemployment and unrest, had, in the past season, fallen by roughly 1.5% compared with the annual long term growth in sales of 2.7%.

The unrest in the townships, he said, had disrupted distribution and it had not been possible to supply sugar to all the outlets.

'Despite this, proceeds from both markets have exceeded R1 000m for the second successive season, notwithstanding the fact in real terms, the export price touched its lowest level.'

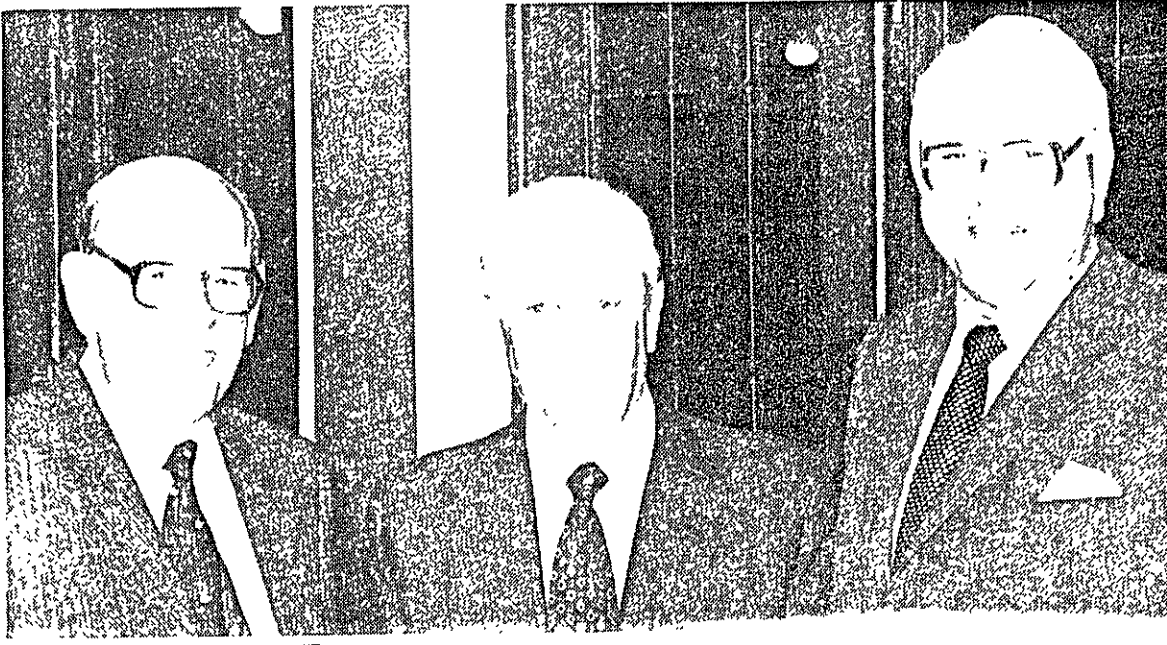

Sugar (3) NIM 24/7/86

Sugar industry stands against apartheid

Finance Reporter

THE South African Sugar Association has emerged from its traditionally low profile on political issues to take a strong stand against apartheid.

The association has passed a resolution expressing its opposition to apartheid and is to draw up an affirmative action programme.

Dr Kees van der Pol, the association's chairman, told the association's annual meeting in Durban yesterday that the anti-apartheid resolution should be regarded as the industry's declaration of intent to promote change to an equitable South African society.

He said that although the industry had a proud record of promoting the position of blacks within the industry, it could no longer remain silent on political issues.

Restoration

'We are not taking sides for or against the Government but must make a stand on such major issues as the abolition of apartheid, power-sharing on an equitable basis and in the restoration of law and order in our society,' he said.

Dr van der Pol emphasised that although the association — which represents 25 000 growers, 16 sugar mills and a central refinery, and employs more than 154 000 people in the KwaZulu/Natal region — had carried out its social responsibilities, much remained to be done.

'But we must not only aim to alleviate the effects of apartheid; we must also work toward the abolition of apartheid by providing leadership within our spheres of influence and openly support and encourage the Government to abolish apartheid.'

Of sanctions, Dr van der Pol said that if they were to be applied successfully against South Africa, they would have serious effects on the 1 000 000 people who were employed by and who depended on the sugar industry.

Misery

The vast majority of these were black.

He said economic sanctions was a polite term for economic warfare, 'the results of which can be as devastating in human suffering and misery as a conventional war'.

The unrest in black townships, which had made orderly despatch and distribution almost impossible in some areas, had not only aggravated difficult trading conditions but was the major reason for a 3% drop in domestic demand.

He said sugar consumption among blacks had declined during the year, and he called for a renewed approach to the fiscus, for removal of sales tax on sugar, to help the poor to use a cheap carbohydrate source.

Acknowledging efforts made by the industry in reducing costs, he said further cost savings could also be expected from the introduction of the A and B Pool pricing systems and from the changed cane transport arrangements which still had to make their impact on the industry.

Surplus

Dr van der Pol said that in spite of the eldana pest and unfavourable weather, the export surplus would continue, but the present price of some US6 c/lb was still well below total cost of production.

However, there was some good news from sugar economists who predicted that the imbalance between supply and demand was moving in favour of the producers and for the first time in recent years, world demand would exceed production.

Although the 1986/87 season appeared to hold better fortunes for the industry than the 1985/86 season had, the present crop was again suffering from drought and eldana in many parts of the industry, he said.

WEDNESDAY

Sasa passes resolution opposing apartheid

THE SA Sugar Association (Sasa) has passed a resolution expressing its opposition to apartheid and is to draw up an affirmative action programme to be carried out in the near future, the association's chairman Kees van der Pol said yesterday.

Speaking at Sasa's annual meeting in Durban yesterday, he said the anti-apartheid resolution should be regarded as the industry's declaration of intent to do what it could to promote changes which would create an equitable SA society.

"Traditionally Sasa has kept a low profile on political issues, but we can no longer remain silent, even though our members represent the entire political spectrum," he said.

While not taking sides for or against government, Van der Pol said Sasa must take sides on such major issues as the abolition of apartheid, the sharing of power on an equitable basis among all sectors of our population and in the restoration of law and order in our society."

Van der Pol said although Sasa — which represents 25 000 growers, 15 mills and a central refinery, and employs more than 154 000 people throughout the KwaZulu/Natal region — had carried out its social responsibilities and had made considerable progress towards a more equitable society, much remained to be done.

"We must not only aim to alleviate the effects of apartheid, but must also work towards the abolition of apartheid by setting an example and providing leadership within our sphere of influence.

"We must openly support and encourage government to proceed in haste with its declared goal to abolish apartheid."

Van der Pol said violence begot violence and all would be losers.

"The abolition of apartheid is not an end in itself to be achieved at any price — it is the means to bring about a just, peaceful and prosperous society in which we can all share."

"I also hope and trust our overseas customers and friends of SA will accept our resolution as an expression of solidarity with their objectives to promote change, and not as an empty response to the threat of sanctions."

Van der Pol said if economic sanctions were imposed, the many forces working for peaceful change within SA would find themselves on the opposite side of those seeking change through sanctions.

"There is another way to promote change, and I refer to the Natal/KwaZulu indaba, in which Sasa is playing an active role, seeking to promote power-sharing in Natal.

"It is my honest belief that we can find a workable structure which could be an example to the rest of our country."

Sasa.

new look at the heavy com- year.

2-17-78 JANTHIE
3 Sugar
Sugar makes GST plea

THE South African Sugar Association (Sasa) will again ask the Government to remove GST on sugar.

Chairman Kees van der Pol told Sasa's annual meeting this week that sugar was the major component of the carbohydrate intake necessary in a healthy diet for lower-income groups.

Dr van der Pol said: "We must renew our approach to the fiscus for the removal of GST on sugar, which is the only non-luxury food item still subject to this tax.

"This injustice cannot be allowed to continue under present circumstances of great hardship among the lower income group," says Dr van der Pol.

Dr van der Pol said most of the world's sugar economists predicted that the imbalance between supply and demand would move in favour of producers in the 1986-87 season. For the first time, demand would exceed supply.

States:

CHISE
RICO

LEPHONE
) 239341

WIDE

29/8/86 BUS DAY

Sugar gets first sweet news in some years

3 SUGAR

MICK COLLINS

THE acerbity felt by the sugar industry for the past few years has been sweetened by falling world stocks and reports of massive Russian buying.

At the start of the 1985/86 sugar season, production was estimated at 2,29-million tons with 1,04-million tons surplus to domestic requirements and available for export.

However, lack of good spring rains hit output, and total saleable production was 2,1-million tons after allowing for refining loss.

With domestic markets being crimped by slow sales, it became necessary to reduce local allocation from 1,23-million tons to 1,19-million. This left a balance of 914 298 tons for export.

Figures released in the annual report of the SA Sugar Association reflect disas-

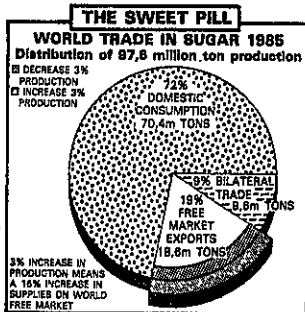

trously low world prices from the start of the season until early July.

Reasons given for the low prices were the level of world stocks, which had been increasing steadily, and at that stage reached an all-time high of 40-million tons.

A sudden turn-around towards the end of July saw the price creep to over \$100/ton and then move steadily upwards until it reached an 18-month high of \$128 in November.

Statistics showed that consumption would outstrip production for the first time in four years during the world sugar year 1985/86 which began on September 1.

Major reasons which impacted on the market were deferments of large tonnages by Cuba and Brazil, due to drought and hurricane damage, coupled with reports of Russian buying.

On the first trading day of March the price jumped by \$10 to \$136 and then followed a steep rise to a 28-month high of \$204,50 on April 8.

Expectations of increasing consumption in Asia, along with drought in the Caribbean, has given the market a more positive outlook for the future.

SASA chairman Frank Jones told *Business Day* that prospects for the current season were better than they had been in years.

and preventing sugar from reaching all its markets, sugar sales last season were down by 1,5% on the previous year.

Seen against the background of a positive 2,7% average growth in the long-term sales trend, and the growing importance of the domestic market in revenue terms, the slide is disturbing.

SASA's national marketing and communications manager, Frans Oosthuizen, says he does not expect this year's sales to be any better than 1985 — and if the political situation deteriorates, sales could fall even further.

"Quite frankly, one does not know what to expect for the rest of the season. With retail consumer expenditure down 7% in real terms, we will be doing well if we merely retain the same level as last year."

Given the high profile of the domestic market, falling sales are likely to have a significant impact on the industry's total earnings this season. However, with the industry's extreme sensitivity to criticism that it uses the price-controlled local market to make good total losses, SASA is unlikely to approach the government for a further price increase to compensate for shrinking sales volumes. "We will simply have to live with it," says Oosthuizen.

What is more likely is that SASA will step up pressure to have sugar added to the list of basic foodstuffs which are exempt from GST. That way it can be assured of an immediate 12% price reduction to help stimulate sales. ■

FIN MAIL 11/11/86
SUGAR SALES (3) 249m

The GST plea

Local sugar sales are taking a pounding — at a time when the domestic market, at both industrial and retail levels, is becoming increasingly important to the industry. Relative sales percentage changes over the past seven years reflect the increasing importance of this.

During the 1977-1978 season, domestic sales contributed 53% of industry income. However, since export prices began to fall six years ago, the industry has had to turn increasingly to the local market for its income. Last season, local sales contributed 77% of total income.

Translated into revenue, the figures tell a similar story. In the past five years, proceeds from local market sales totalled just over R3 billion, while export earnings over the same period barely approached R1 billion.

The steadily rising local sugar price is a major force behind the slowing sales pattern — as South African Sugar Association (SASA) officials confirm. The over-the-counter price of 2,5 kg of white sugar in Johannesburg is now R2,40. Industrial users pay R758/t.

This year, for example, the domestic sugar price was increased by 15%. Annual increases of this order have become an accepted pattern in the industry — although SASA is quick to point out that the long-term trend in price increases is below that of the CPI.

With the negative impact of a sluggish economy, high unemployment and the unrest situation disrupting the distribution pipeline

GLOBAL MARKETING

Hitting the target

The world is becoming ever more homogeneous as people come to demand the same kind of products wherever they may be.

LES PHIPPS

Les Phipps, assistant manager (advertising) for the *FM* and *Business Day*, died peacefully at Montana Guest Farm, Magaliesberg, on Sunday. He was 62.

He was born in London in 1923, and his first job — which he took at 15 — was with Afrikaanse Pers Beperk (APB), which ran an operation in London at that time. During World War II Phipps served with the RAF after which he rejoined APB as office manager.

He came to SA (to work here for APB) in 1964, and was appointed Advertisement Manager of the *Financial Gazette*



③ SUGAR BUSINESS 12/8/56

BUSINESSMEN can no longer stand aside from political issues at stake in SA, says SA Sugar Association (Sasa) chairman Kees van der Pol.

"Traditionally Sasa has kept a low profile on political issues, but we can no longer remain silent. We must now work towards abolition of apartheid by setting an example."

Reporting on a resolution adopted by the Sasa council, unanimously opposing apartheid, Van der Pol says such a resolution should be seen as a message of intent.

In an editorial in the *Sugar Journal*, Van der Pol says Sasa will do what it can to promote change which

Sugar men out to fight for change

MICK COLLINS

will result in creating an equitable society in SA.

"I also hope our overseas customers and friends will accept our resolution as an expression of solidarity

with their objectives to promote change in our country and not as an empty response to the threat of sanctions."

Sanctions would have serious effects on the 25 000 sugar cane growers, 21 000 of whom are black.

"It will have serious effects on the more than 1-million people employed by and dependent on the industry, the vast majority of whom are black.

"Economic sanctions are but polite words for economic warfare, the results of which can be as devastating in human suffering and misery as a conventional war."

Threat to S^A

NATL REC
2/18/86

sugar export

(3) Sugar

Finance Editor

SOUTH Africa's exports of sugar to the United States are at stake.

A Washington newspaper reported yesterday that Sen Richard Lugar, chairman of the Senate Foreign Relations Committee, had said in speeches in the Philippines this week that South Africa's sugar quota would be given to that country.

A spokesman for the South African Sugar Association in Durban confirmed the report and said the association was waiting to see what happened.

Cementing ties

About 35 000 tons of sugar a year is sent to America from South Africa and is worth in the region of R14 million.

Simon Barber reports from Washington that although the measure, an amendment to a sanctions Bill in the Senate, has yet to become law, the United States is anxious to cement ties with the Aquino Government in the Philippines to protect its key air and naval bases on the archipelago nation.

The value of South African sugar imports into the United States has risen steadily even though the United States produces a surplus of its own, according to the U S Commerce Department.

The strong bipartisan support for the quota transfer, plus the fact the the quota system has been used as a form of development aid to friendly nations, makes it likely that the amendment will take effect even if the sanctions Bill is not signed by President Reagan.

Observers said last night that if exports to America were stopped the loss in sales was not expected to have any material affect on the local sugar price although the country would have to look for alternative markets.

They said the local price of sugar was determined according to production costs and this meant that it bore very little relation to the world's price of sugar, which is currently in the region of R400 a ton. The local price is about R650 a ton.

South Africa's sugar, while selling at the world price, is highly competitive because of its quality and the reliability of supply, which is not the case with the Philippines.

Sales pit



State concedes two regulations invalid

Pietermaritzburg Bureau

TWO emergency regulations which dealt with news reports on the conduct of the police and the presence of journalists in black townships and unrest areas were invalid, counsel for the State conceded in the Supreme Court, Pietermaritzburg, yesterday.

This move came during legal argument before judgment was reserved in an application by four newspaper groups challenging the validity of six emergen-

Police, Mr Jan Combrink, SC, conceded that the two orders issued by the Commissioner of Police in terms of Regulation 7 (1) (c) of the emergency regulations were invalid because they were promulgated by means of a telex message to the South African Press Association.

The concession means that the Court need not decide on that particular issue.

The orders prohibited reporting on 'any conduct of a force or member of a force' regarding the maintenance of public safety, order or the termination of the state

without prior consent.

In terms of Regulation 8, the only means of promulgation of orders under Regulation 7 are: by notice in the Government Gazette; in a newspaper; radio or television; distribution in writing among members of the public and affixing it on public buildings or prominent public places in the area concerned; handing it to a particular person in written form; an oral announcement to any particular person or the general public.

Censorship

During yesterday's argu-

entitled to seize a newspaper which stood to lose hundreds of thousands of rands.

Mr Justice Leon said it was not necessary for him to have good grounds for his action since the matter was subject only to his opinion, which might be incorrect.

In this event, newspapers would not have recourse to the courts since an opinion could not be tested objectively.

Mr Combrink submitted that the regulation fell within the powers of the State President but said as

21 18186
UN-SUGAR
Natal pill
3 SUGAR
SIMON BARBER

WASHINGTON — Natal sugar producers stand to lose about \$33m in export earnings under the sanctions Bill passed by the US Senate last Friday.

The Bill transfers the 39 000-ton US import quota allotted to SA to the Philippines.

Though the measure has yet to become law, Senator Richard Lugar, chairman of the foreign relations committee, referred to the quota transfer in talks with the Filipino President Corazon Aquino in Manila earlier this week.

The US is anxious to cement ties with the Aquino government to protect its air and naval bases in the Philippines.

The strong bi-partisan support for the quota transfer, plus the fact the the quota system has been used as a form of development aid to friendly nations, makes it likely that the measure will take effect, even if President Ronald Reagan does not sign the Bill.

SA sugar quota for the Philippines

Own Correspondent

WASHINGTON. — Natal sugar producers stand to lose about \$33 million worth of export earnings under the sanctions bill passed by the United States Senate last Friday.

The bill transfers the 39 000-ton US import quota allotted to South Africa to the Philippines as a result of a unanimously adopted amendment offered by Massachusetts Senator John Kerry.

Though the measure has yet to become law, Senator Richard Lugar, chairman of the Senate Foreign Relations committee, pointed to the quota transfer in talks with the President of the Philippines, Mrs Corazon Aquino, in Manila this week.

The US is anxious to cement ties with the Aquino government to protect its key air and naval bases there.

The value of South African sugar imports into the US has rocketed from \$1,5 million in 1981 to \$33,2 million last year even though the US produces a surplus of its own, according to the US Commerce Department.

DAILY PLSA 3/9/66

City part of new plan for transporting ³ sugar

Dispatch Reporter

EAST LONDON — The South African sugar industry has started moving one-ton semi-bulk bags of sugar through East London, Port Elizabeth and Cape Town.

The new service is aimed primarily at meeting the needs of industrial customers who are not served by the industry's bulk sugar delivery service.

The general manager of South African Sugar Distributors (SASD), Mr Dennis Laggar, said yesterday that as the scheme developed and customers were able to handle bags, it would be possible to service industrial sugar users nationwide through road, rail and shipping links.

The East London port manager, Mr Sarel Broodryk, said details on how harbour officials were going to handle the project had not been finalised.

It would not lead to an immediate increase in harbour activity.

"However, there is a possibility that some of the cargo might come back to the sea routes," Mr Broodryk said.

The general manager of a mineral water bottling company in the city, Mr Scotty Loewe, said his company was "definitely investigating the feasibility" of the bags.

It appears to be the direction in which the industry is moving," he said.

The managing director of a sweet company in the city, Mr Graham Millar, said the company was about to run trials to see whether the bags were suitable.

"We are doing this in close contact with the South African Sugar Association and we hope the trials are successful," Mr Millar said.

Mr Laggar said the SASD had signed a six-year contract with the South African Sugar Association to receive sugar in one-ton bags.

The bags are made from polypropelene and are returnable on a deposit basis.

"There are a number of advantages for industrial users of the bags, including savings in labour and handling charges, spillage and pilferage, as well as (in) costs involved with the disposal of the empty bag," Mr Laggar said.

He said 12 000 tons of sugar were expected to be transported in one-ton semi-bulk bags this season. The tonnage could "very well" be higher.

The SASD were anticipating a demand for 50 000 tons in the coming season.

The first delivery of 100 tons was despatched recently to a firm in Port Elizabeth.

③ SUGAR

Future looks a little sweeter for the SA sugar industry.

MICK COLLINS

around towards the end of July when prices soared to over the \$100 mark. Thereafter, it moved steadily upwards until it reached an 18-month high of \$128 on November 6.

Statistics showing consumption outstripping production during the 1985/86 season contributed to the increase. Speculators selling the market stopped the movement and during the next 11 weeks prices dipped to reach \$96.50 in January this year.

By the end of February, however, the price had improved to \$126 a ton.

On the first trading day of March, prices jumped by \$10 and continued upwards to a 28-month high of \$204.50 on April 8.

Recent forecasts suggest that the statistical position is undergoing radical change. Consumption has continued to improve while there has been a marked set back in production.

The key question facing producers is not whether there will be a recovery in prices — this has already begun — but at what ceiling prices will falter.

The protectionist action by developed countries has resulted in the free world market becoming smaller and, potentially, more volatile. On the other hand, it was expected that higher prices would limit buying earlier than in the previous periods of rising prices.

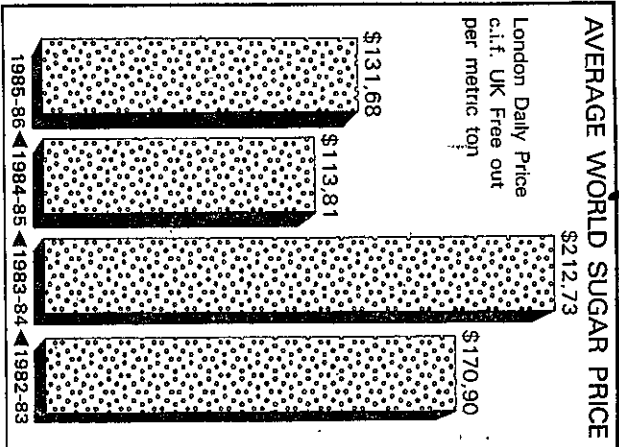

KWV maintains dividend

Investment Staff

KWV Investments has maintained its final dividend at 9.80c for an unchanged total payout for the year ended June 30 of 15.80c although earnings per share slipped from 15.857c to 15.814c on net taxed income of R6,64m (R6,66m). — Sapa.

2. In the Afrikaanse teks van die Bylae:
- (1) In Afdeling A, klousule 3 (48), vervang die syfer "46" deur die syfer "45".
 - (2) In Afdeling A, klousule 30 (d), vervang die syfer "46" deur die syfer "45".
 - (3) In Afdeling B, klousule 3 (1) (f), vervang die uitdrukking "een-ses-en-veertigste" deur die uitdrukking "een-vyf-en-veertigste".
 - (4) In Afdeling B, in die voorbehoudsbepaling by klousule 5 (4), vervang die syfer "46" deur die syfer "45".

2. In the Afrikaans text of the Schedule:
- (1) In Division A, clause 3 (48), substitute the figure "45" for the figure "46".
 - (2) In Division A, clause 30 (d), substitute the figure "45" for the figure "46".
 - (3) In Division B, clause 3 (1) (f), substitute the expression "een-vyf-en-veertigste" for the expression "een-ses-en-veertigste".
 - (4) In Division B, in the proviso to clause 5 (4), substitute the figure "45" for the figure "46".

No. R. 2042

26 September 1986

WET OP MANNEKRAGOPLEIDING, 1981

MANNEKRAGOPLEIDINGSKOMITEE VIR DIE SUIKERVERVAARDIGINGS- EN RAFFINEERNYWERHEID—WYSIGING VAN LEERVOORWAARDES

Ek, Pieter Theunis Christiaan du Plessis, Minister van Mannekrag, handelende kragtens artikel 13 van die Wet op Mannekragopleiding, 1981—

- (a) wysig hierby, met ingang van die derde Maandag na die datum van publikasie van hierdie kennisgewing, Goewermentskennisgewing R. 1257 van 14 Junie 1985 deur klousule 3 (1) van die Leervoordes deur die volgende klousule te vervang:

“(1) 'n Werkgewer moet 'n vakleerling besoldiging teen minstens ondergemelde persentasies van die loon wat aan 'n ambagsman betaalbaar is ingevolge enige nywerheidsraadooreenkoms wat op die betrokke ambag en gebied van toepassing is:

4-jaar ambagte	5-jaar ambagte
Eerste jaar: 40%	Eerste jaar: 40%
Tweede jaar: 45%	Tweede jaar: 45%
Derde jaar: 55%	Derde jaar: 55%
Vierde jaar: 100%	Vierde jaar: 70%
	Vyfde jaar: 100%”;

- (b) wysig hierby klousule 9 van die Leervoordes deur die voorgeskrewe opleidingsbylae vir die aange-wese ambag van Passer deur die volgende opleidings-bylae te vervang:

No. R. 2042

26 September 1986

MANPOWER TRAINING ACT, 1981

MANPOWER TRAINING COMMITTEE FOR THE SUGAR MANUFACTURING AND REFINING INDUSTRY.—AMENDMENT OF CONDITIONS OF APPRENTICESHIP

I, Pieter Theunis Christiaan du Plessis, Minister of Manpower, acting in terms of section 13 of the Manpower Training Act, 1981, hereby—

- (a) amend, with effect from the third Monday after the date of publication of this notice, Government Notice R. 1257 of 14 June 1985 by the substitution for clause 3 (1) of the Conditions of the following clause:

“(1) An employer shall remunerate an apprentice at not less than the following percentages of the remuneration payable to an artisan in terms of any industrial council agreement applicable to the relevant trade and area:

4-year trades	5-year trades
First year: 40%	First year: 40%
Second year: 45%	Second year: 45%
Third year: 55%	Third year: 55%
Fourth year: 100%	Fourth year: 70%
	Fifth year: 100%”;

- (b) amend clause 9 of the Conditions by the substitution for the prescribed Training Schedule for the designated trade Fitter of the following Schedule:

“Log-boek simbool	Soort werk	Praktiese opleiding	Getal ure aanbeveel vir onderrig in elke soort werk
		7. AMBAG: PASSER (4)	
1.	Veiligheid.....	Basiese veiligheidsmaatreëls van toepassing in die ambag moet die hele leertyd deur nagekom word, met besondere aandag aan die veilige hantering en versorging van handgereedskap, skadelike en vlambare gasse, vloeistowwe en gasse onder druk, warm en gesmelte metaal, elektriese installasies, masjienbeveiliging, masjien- en drukkluggereedskap, slypwiele, bewegende en oorhoofse masjinerie, en die gebruik van draagbare brandblussers. Behandeling vir elektriese skok	45
2.	Basiese hand- en werkwinkel-gereedskap	Die versorging en gebruik van gereedskap. Die maak van werkstukke en/of onderdele met gebruikmaking van die tegnieke kap, boor, vyl, ruim, saag, skraap, skroef-draadsny en moerdraadsny. Snygereedskap skerpmaak, die gebruik van trekkers en perse. Die keuse n gebruik van smeermiddels en snymengsels. Wiele van slypmasjine bywerk, rond, nagaan en monteer. Die gebruik van gasuitrusting vir sny- en verhitingsdoeleindes. Elektriese hegsweiswerk	450
3.	Afmerkwewerk.....	Van tekening en/of monsters af afmerk, met gebruikmaking van afmerkgereedskap, bv. hoekplate, flesdomkragte, senterponse, verdeelpassers, afmerktafels, gradeboë, liniale, kraspenne, winkelhake, krasblokke en V-blokke. Die gebruik van meetinstrumente en meters	180
4.	Tekeninge en sketse.....	Tekeninge en/of sketse maak. Tekeninge lees en begryp.....	180
5.	Materiale.....	Kennis en identifisering van materiale.....	45
6.	Koppelings.....	Die montering, rigting en onderhoud van en foutdiagnosering by verskillende soorte koppelings, bv. buigsame, soliede en selfkoppelings	180

SUGAR GROWERS

3 SUGAR
FMA

Timber takeovers

7/11/86

Sugar growers may have had it good recently, but low world prices and the poor prognosis for a recovery are increasingly signalling that the halcyon days are over.

Many South African growers are consequently quitting the industry or turning their farms over to alternative uses.

In the Richards Bay, KwaMbonambi and Felixton areas the big timber interests in the form of Mondi and Shell have found sugar farmers to be willing sellers.

Since the beginning of the year both have added around 12 000 ha of former cane land to their already significant timber holdings. The idea is to build up a strategic timber store to supply the new Mondi paper mill at Richards Bay.

Sugar Growers' Association chairman Laurie Gordon-Hughes says it is more a question of internal rationalisation within the sugar industry than a case of hard-pressed cane growers desperately casting around for buyers.

He says it was inevitable that the multiple pool system and changes in the cane transport system would force farmers to look hard at the economics of their operations.

An added inducement could well be the prices timber growers are apparently prepared to pay. The going rate is said to average around R3 000/ha but, according to Gordon-Hughes, on occasion farmers have received as much as R7 000/ha.

Mondi Paper MD Tony Trahar denies that timber interests are paying over the top for cane land. He says current prices range

from R1 000/ha to R3 000/ha, adding that they do, of course, have to compensate farmers for any timber or cane in the ground.

Trahar says Mondi has already bought around 7 000 ha and its purchasing programme in the area is virtually complete. He confirms the objective is to acquire a strategic store of timber close to its mill to minimise escalations in timber transport costs.

Shell's objective, notes chairman John Wilson, is slightly different from Mondi's. About three years ago the group took a strategic decision to move into timber growing. Since then it has consolidated its timber interests by buying farms adjacent to its original acquisition, the Loring Rattray estate in KwaMbonambi. In all, about five farms totalling 5 000 ha have been acquired. Prices, he says, averaged around R3 000/ha.

Gordon-Hughes predicts that the sale of cane farms, especially in marginal areas far from sugar mills, could well accelerate. In addition, he says, some farmers are making use of the soft loan incentives offered by the Department of Environmental Affairs and the Natal Timber Co-op to convert land formerly under cane to timber.

However, long term, the change-over could have adverse consequences for the sugar milling industry, which relies on high volumes of cane throughput for its viability. Tongaat-Hulett's new mill at Felixton looks especially vulnerable.

How much cane tonnage will ultimately be lost to timber, nobody really knows. It will depend on the notoriously fickle international sugar market.

Sugar boom is bad news for rally

ALTHOUGH the sugar market is entering a period when prices would normally be on an upward trend, improved crops and limited demand are constricting rallies.

Broking firm Shearson Lehman says in a quarterly review that unless there are unforeseen crop problems, prices are expected to fluctuate between 5,5 US cents and 7,50 US cents a pound on the basis of a New York March delivery.

Several countries — India, Brazil and Pakistan — changed production plans when higher prices prevailed earlier this year.

Good weather in Europe also means that output will not be as severely affected as previously thought.

World sugar production for 1986/87 is expected to reach 100,5-million tons raw value — over and above a huge current surplus — compared with 96,5-million tons in 1985/86.

Meanwhile, sugar consumption is booming in Brazil, says the *SA Sugar Journal*. There is a huge demand in the wake of the Brazilian government's anti-inflation package.

From West Germany it is reported that sugar statistician F.O. Licht has estimated that world consumption will rise to 102/103-million tons for the 1986/87 season and this means that for the second year running demand is likely to exceed production.

vation systems for airlines. From 1969-1977, he was Sats manager, data processing; in 1979 he was made regional manager for Natal and in 1981 assistant GM operations of the SA Railways. ■

PAT BODASING

A sweet story

When the SA Sugar Association (Sasa) declared itself to be firmly against apartheid at its annual meeting a few months ago, this was interpreted in some circles as merely a hollow utterance. But Parthabsing "Pat" Bodasing's appointment this week as an executive member of the SA Cane Growers' Association is evidence that there was real intent behind Sasa's pronouncement.

Bodasing is the first Indian to be elevated to the Cane Growers' executive, a body which represents the interests of cane growers at the highest level nationally. At the same time, Bodasing took up his seat as an alternate member of the SA Sugar Council, the industry's top policy formulating body, representative of both the growing and milling sectors of the business.

It was a personal triumph for Bodasing, one that affirmed his commitment to working towards a truly nonracial sugar industry, rather than simply accepting what amounted to second-class status as an Indian cane grower.

"I feel that I have been instrumental in removing unnecessary racial tags from the industry — and that's a good feeling," he says proudly.

In the past, historical precedent precluded blacks from advancement in the administration of the sugar industry's affairs. In the 18 years that Bodasing served as vice-president and president of the Natal Indian Cane Growers' Association, the body enjoyed only affiliate membership of the SA Cane Growers' Association — that is until the industry took a hard look at itself this year and rewrote its constitution.

It's not as if the industry resisted the change. As Bodasing points out, there have always been exceptionally cordial relations with other growers. It was more a question of working out the logistics of a proper amalgamation.

"The democratic process had to take its course," says Bodasing. "I'm very happy about the way things have turned out." Bodasing makes the point that in Sasa's new nonracial structure, even the most senior jobs, such as vice-president and president, are not beyond his grasp.



Bodasing . . . raising cane

Softly-spoken and dapperly dressed, Bodasing hardly looks like the sort of man who would spend the best part of his day behind the wheel of a tractor. But now that he has achieved what he set out to, he says his intention is to return to playing his principal role as a farmer in the field.

Highly regarded throughout the industry, Bodasing is eminently qualified for his new position. Of the 1 600 Indian sugar growers in Natal who collectively deliver about 6% of the country's total cane output to the mills, Bodasing's family is one of the leading growers.

Like that of many other growers, the Bodasing landholding is a legacy of the elder Bodasing who came to Natal in 1870 as an indentured worker on the sugar estates. At the conclusion of his contract, he bought half an acre on the North Coast and started farming for himself, first with tobacco. His estate included 7 000 ha of prime sugar cane land in the Stanger-New Guelederland area which the family still owns.

After completing his schooling at Sastri College in Durban, Bodasing decided to work the farm. Some of his brothers chose a different route and went on to become professional men, lawyers and doctors. He sees himself as first and foremost a farmer, rather than a businessman with a farming interest. And he can turn his hand to any chore on the farm from ploughing fields to fixing broken water pumps.

In his own way, Bodasing has spent the bulk of his life chipping away at apartheid practices within the sugar industry. His own father actually left SA for a while to live in Scotland. This, however, was never an option for the younger Bodasing: "I felt I had to be here, go through it and help make the changes. I've always been committed to breaking apartheid down. That I've been successful in some respects makes me feel proud." ■

Sugar producers to appeal to US

THE South African Sugar Association (Sasa) is to appeal to the US government to be taken off the list of 166 SA parastatals covered by terms of the Anti-Apartheid Act.

Sasa will join seven other organisations which have already appealed.

Reacting to Press reports that Sasa had withdrawn an appeal because of insufficient documentation, a spokesman said yesterday the reports were incorrect.

"Sasa has not yet appealed to be taken off the US government's list of SA parastatals, although such a submission is under discussion."

He said no definite time had been set for the plea, but stressed that Sasa was not a parastatal and "we wish to bring this to the attention of the US government as a matter of principle."

"Regarding the SA sugar quota, which has been transferred to the Philippines under a separate section of the US law, the association will obviously make representation to re-acquire this when the time is ripe."

The spokesman was referring to the sections of the law which has seen SA sugar imports banned outright, including the transfer of SA's US import quota to the Philippines.

Industry sources said yesterday the association was viewing the US ban as two separate issues, the more important being the ban on SA sugar imports.

The other issue, which has direct im-

31/12/86. BUD DAI
MICK COLLINS
applications for Sasa in its dealings with US suppliers, is the parastatal stigma, which the association hopes to eradicate.

The other seven appellants are Mercedes Datakor, Sasol, Putco, the CSIR, Siemens SA, Comtec and Technetics.

The US State Department's list of the 166 SA organisations was published on November 10 in compliance with the law banning imports from any corporation, partnership, or entity owned, controlled or subsidised by the SA government.

AGRICULTURE - SUGAR

1987

FEB - NOVEMBER

17/2/87
**Sugar industry
'at crossroads'**

(3) *Sugar*
GERALD/REID B/D

THE SA sugar industry has reached a crossroads, the Sugar Association of SA said yesterday.

In a paper tabled at the Agricultural Outlook Conference (Agricon) in Pretoria it said it had to be accepted that sugar had reached a mature stage; domestic market growth prospects were limited; and long-term prospects for profitable exports were remote.

The industry would need to exercise all its ingenuity to improve economic prospects. This could demand a change in policy away from regarding sugar as its major product, and looking to other sugar products as increased revenue earners.

"The industry is set on a survival course and may well emerge leaner."

W/Mail 2/12 5/3/87
WAA
(3) Sugar

The white rigger who joined black union

AN Afrikaans worker fired by the Felixton sugar milling company in the course of his campaign to improve working conditions for blacks has sought the support of a black trade union.

Fifty-year-old Dennis Strydom claims racism, dangerous working conditions and exploitation of the black work force at the sugar mill led him to join the Food and Allied Workers Union.

A rigger at the sugar mill before being fired early this month, Strydom says he joined Fawu after his own one-man campaign against the company became too much for one person.

He claims overhead cranes lacked brakes and that black workers were made to do skilled work but were not paid for it because they had been

By PHINDA KUZWAYO, Durban

employed at much lower grades.

He may have made history when he became the first known white person in the area to be represented by a black union official after his activities at the sugar mill got him into trouble.

He was summoned to a hearing under the company's disciplinary procedure, charged with inciting black workers, making threats to his foreman, writing letters to management and not clocking his clock card.

Wrote Cosatu national general secretary, Jay Naidoo: "I appreciate that you have committed yourself to building Fawu by joining and participating in its activities."

Strydom says things became so bad

for him at the mill that he was isolated by the rest of the white work force. "My clock card was defaced and obscene language scribbled on it. I was called a 'kaffir-boetie'," he says.

At the beginning of the month he was told his contract would not be renewed when it was scheduled for review at the end of February. But after *Weekly Mail* approached the company three weeks ago about allegations made by Strydom, he was summoned into the foreman's office and told he need not bother to work until the contract officially expired.

A company representative, Ron Phillips, claims Strydom was dismissed because his work was not satisfactory.

Strydom disputes this. He says he had served a three-month probation

period when he started the job a year ago and there had been no complaints about his performance.

Although Phillips had promised his company would respond to the allegations in a written statement, he later phoned and declined to respond to details or allegations which Strydom claims led to his dismissal.

"We have investigated each and every one of the allegations but we are not prepared to discuss employer/employee relationships in the columns of the press," he said.

Meanwhile Strydom has kept a sheaf of correspondence mainly with line management. He has also written to the chairman of the Tongaat-Hulett group, Dr Chris Saunders, asking him to intervene in the situation at the mill.

Balancing the books

MM 6/3/87

③ Sugar

You've got to hand it to SA's sugar farmers: they seem to have learnt to live with adversity. After the terrible droughts of the past, sugar farmers are predicting that they are likely to end the season, which closes this month, with a modest surplus.

That's a laudable recovery — especially after some of the industry's major customers abroad took Foreign Minister Pik Botha literally at his word and did "their worst" by imposing sanctions on our sugar imports.

The political pique inherent in the US Congress's sanctions Bill and Canada's decision to slap a ban on agricultural imports

Better world prospects for sugar — sanctions notwithstanding — mean the South African industry is in a position to begin redeeming debt. And the realisation appears to have hit home that it cannot again allow itself to ride out bad years without regard for its overall financial structure.

which sells half its annual production of 2 Mt on the export market, is understandably edgy. It is still thought to be vulnerable in several areas.

Nevertheless, the word is that the industry expects to end the season much the same as it did the previous one — with proceeds marginally over R1 billion against total costs of slightly under R1 billion. Any surplus that there is will as usual be used for loan re-

demptions and disbursement to growers and millers.

The obvious question is: in a hostile and sanctions-beset international environment, complicated by stubbornly low world sugar prices, how has it been possible for the industry to emerge from the ring looking so good?

The short answer is good rains. At an estimated 2,1 Mt the 1986-1987 crop is running slightly above par. Moreover, earnings were significantly boosted by the crunch in the rand-dollar exchange rate which saw proceeds from SA's dollar-denominated sugar sales rising to an all-time high. Add to that two 15% hikes in the domestic sugar price in 12 months — one in March 1986 and the other in January — and the explanation

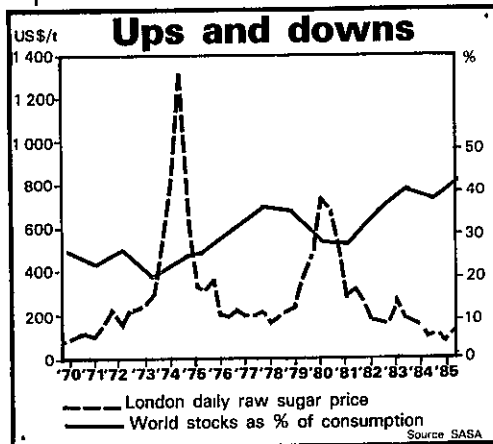

cost the industry around US\$25m. In spite of that, the South African Sugar Association (Sasa) expects to end the season with some cash in hand after its costs have been covered.

Information on the industry's markets and financial position is sensitive as there is a pervasive feeling that the worst is not yet over as far as sanctions are concerned. Sasa,

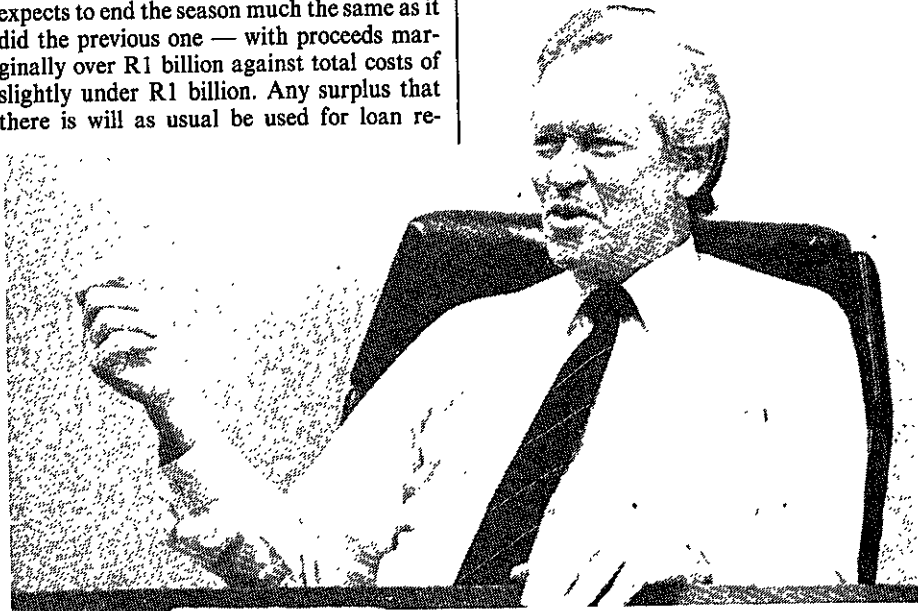

Sugar Association's Sale ... moving a mountain of debt



Digging deep

Analysis of sugar industry finances

Position of price stabilisation fund and deficit financing

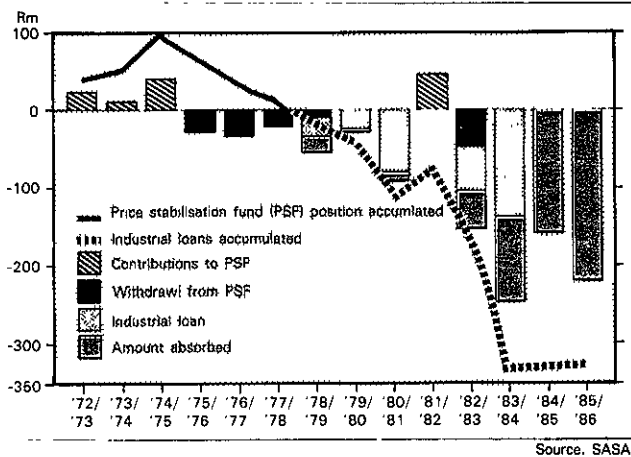

Source: SASA

becomes even clearer.

"It was, overall, a pretty grotty season," says Smith Sugar MD, Glyn Taylor. "If it hadn't been for the money made on the exchange rate, we would be in deep trouble."

What complicated matters was that fluctuations in the exchange rate were accompanied by some equally wild gyrations in the world sugar price. In the past 18 months sugar prices have gone from US3c/lb to US8c/lb. The average price for the current season was US6c/lb.

Even for agriculturists accustomed to battling with the vagaries of climatic conditions and wild swings in commodity prices, most are apt to equate the season with a stomach-lurching roller-coaster ride. "It was just too dramatic for words," says Taylor.

It's early days yet, but the good news for the industry is that the season ahead looks slightly more promising. The year has certainly started well. World prices, which were being quoted in New York in early January at 5,3c/lb, were up to 7,2c/lb by the month's end and are currently still around 7,3c/lb.

This, coupled with the good rains at the start of the growing season, has given rise to optimism that 1978-1988 could be a turning point in the industry's fortunes. Brokers, notes Taylor, are already quoting sugar forward at around 8c/lb for October deliveries and some have the sugar price reaching double digits before the end of the year.

Sasa GM, Peter Sale, tends to be a little more conservative. He forecasts the price reaching 8c/lb for 1987, moving through 10c/lb to 15c/lb by the end of 1989.

But before farmers rush out and merrily dance a jig it must be remembered that sugar is notoriously cyclic. More than a few experts have had their reputations, not to mention egos, shattered by attempting to plot the sugar price a year in advance.

For all that, there are indications that the sugar market could be entering a recovery phase. Restructuring in the Brazilian economy and an under-estimation of the total demand for ethanol has left the Brazilian sugar crop dangerously on the short side. On top of that has come the drought in Cuba, which has turned Russia — which has first

call on the Cuban crop — into an aggressive buyer on the world market. Closer to home there has been the damage wrought by Cyclone Clotilda on the Mauritian sugar crop.

Wishful thinking it might well be, but conventional wisdom has it that negative sentiments over the crop availability tend to be compounding. The perceived shortfall in the market invariably has buyers scurrying to place orders.

The converse argument is that sugar is a mature industry with world consumption falling and increasing competition from rival sweeteners indicating that future peaks should be shorter and the valleys markedly longer.

If the bulls are right — cyclical peaks in the international sugar market have been known to bale out the local industry before (see graph) — it could only mean another lucky break for the industry.

Since the early Eighties it has been carrying a R327m debt as a throwback to the under-recovery of costs in the bad years. The industry's barely breakeven position, in which it has ended the last three seasons with little or no surplus, has meant that it has financially not been in a position to make a start on debt redemption. The matter is now becoming pressing. With interest on its debt running at between R40m and R50m annually, the industry sees its debt burden as little less than a great big noose around its neck.

Sale says a formula has been discussed whereby a portion of all surpluses, starting this season, will in future be directed towards debt repayment. Naturally, the contribution this season will of necessity not be all that significant, given the anticipated small size of the surplus. The corollary, however, is that if the pundits are right and the price does bounce back in the coming season, the surplus available to be channelled into debt repayment would make a far more meaning-

ful impact on reducing borrowings.

Both growers and millers are keen to see at least a start made on debt redemption. It stands to reason that if the debt slate were cleared, there would be an immediate R50m fillip to the industry's bottom line. After years of marginal earnings, it needs it.

Perhaps understandably, given their relative resources, most pressure to have the debt repaid is coming from the corporate sector. Taylor, for one, says he would like to see a far more "vigorous" approach to the problem.

Looking in his rearview mirror, Cane Growers' chairman, Tony Ardington, admits it was probably a mistake to incur such heavy borrowings through the bad years; or, as he puts it, for the industry to "pay out capital as income." Even with the prospect of a few better years ahead, he accepts that "getting on top of the debt is going to be an uphill slog for growers." Nevertheless, just about everyone is in agreement that the sacrifice has to be made — or the industry runs the risk of ultimately undermining its future.

Whether the industry will ever again go into the red and incur huge industrial loans to cover shortfalls in its revenue is a moot point. Sale merely says that each situation will be treated on its merits. The likelihood, however, is not strong. There is a definite reluctance to get badly geared again. Moreover, there is a growing realisation that the sweet life could be over and that in future the industry will have to ride out the bumps on its own.

Certainly, there is a limit to the proceeds it can expect from domestic sugar sales. The local market already contributes some 77% of the industry's total annual income. Even if diehards do exist who believe the domestic market could be good for a bit more, the decline in sugar sales, due mainly to price resistance among black buyers, should tell them otherwise. In the past five years local sugar sales have grown at an average rate of 1,7% a year as opposed to the long-term mean of 2,8%.

From now on the industry can expect no more than a once-a-year sugar price adjustment in line with inflation; and even that, many believe, is excessive in the current inflationary environment.

In the light of the industry's much improved short-term scenario, much of that remains academic. The industry is not yet out of the woods and there are still many imponderables. For example: what, above all, will happen to the rand-dollar exchange rate?

A 30% appreciation of the rand against the dollar effectively reduces the industry's overseas earnings by a like amount. And can the local market price, already considered to be in high ground, realistically be pushed any further up?

Nobody can give accurate answers to these questions. Suffice to say that if there is a recovery in the world market, it would certainly help the industry out of the debt hole it seems to have fallen into.

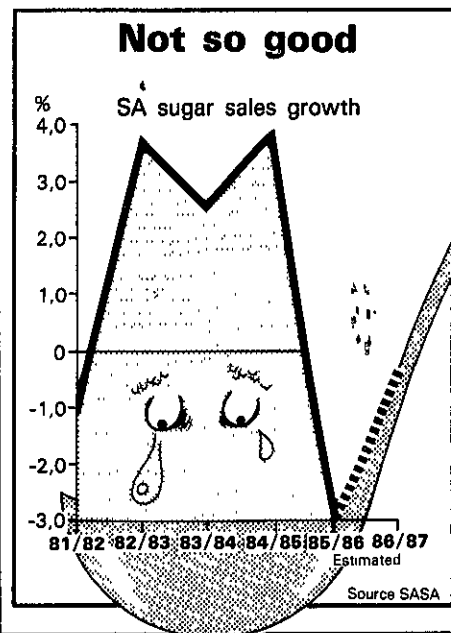

Source: SASA

THE Tongaat-Hulett group has produced sparkling results for the year to March, with earnings rising 249,2% from 24,4c to 85,2c a share.

The improved performance, coming in the wake of better trading conditions and reduced interest rates, exceeded earnings expectations of 75c a share indicated in November's interim report.

The final dividend has been raised from 9c to 24c to lift the total payout by 183,3% to 34c (12c) a share. This places the shares on a dividend yield of 2,8% at yesterday's price, which firmed 20c to R12 — almost double its low of 675c last June.

Turnover advanced 15,8% from R1,8bn to R2,1bn and profit before interest jumped 30,3% from R136m to R177,2m. A 29% fall in the interest bill to R70,3m (R99m) boosted pre-tax profit 188,9% to R106,9m (R37,9m).

The tax bill more than doubled to R39,8m (R12,3m), leaving taxed profit 171,7% higher at R67,1m (R24,7m). A de-

Sweet results

from Tongaat

B/Day 14/5/87 Sugar (3)

MERVYN HARRIS

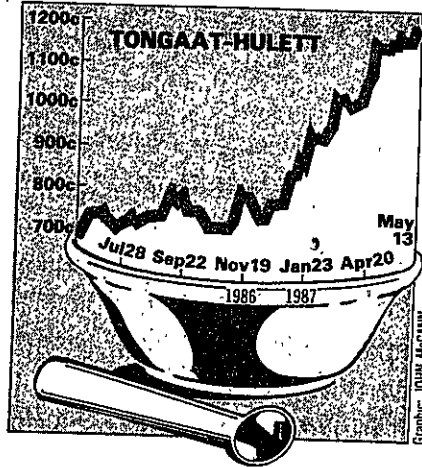

● To Page 2 →

Tongaat earnings show an impressive rise

cline in minority shareholders' interest boosted earnings attributable to shareholders to R62,6m (R17,9m).

The directors say the textiles and industries divisions have returned to profitability. The foods, aluminium and starch sweeteners divisions all report satisfactory profit improvements.

The contribution from the building materials division was similar to that of the previous year. The sugar division performed to expectations, although its

(3) Sugar 14/5/87 B/Day
 ● From Page 1

contribution was lower than last year. Proceeds from the disposal of investments, together with tighter working capital controls and the earlier receipt of sugar proceeds arising from the change in the SA Sugar Association year-end, resulted in a reduction of total group borrowings of about R120m to R380m at March.

Going down

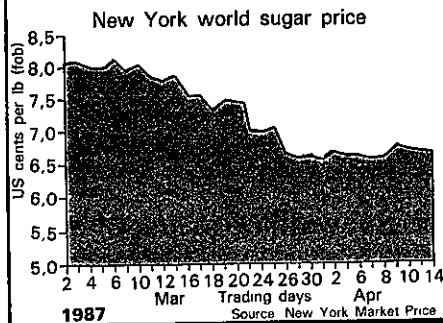

take is that prices have not moved up as expected."

Whether prices will move up to the double-digit levels industry spokesmen were predicting a few months ago, is a moot point. If anything, sugar is a commodity notorious for its irrationality — so much so that Sale contends long-term price movements are virtually unquantifiable. Any firming in the price, he says, seems to attract new stocks to the world market, while the reverse tends to spark renewed buyer interest. So, just where the price will go this year is anybody's guess.

Probably of more immediate concern, though, is the recent appreciation of the rand against the dollar. Since January the rand has risen 25% in dollar terms, resulting in a concomitant drop in industry earnings on sugar sold internationally in dollars. Last season the industry's export earnings were considerably enhanced by the favourable dollar exchange rate which averaged

US44c.

Sale confirms the rising rand is a source of concern — especially with world prices in a trough. "Naturally, as exporters, we prefer a 40c/rand to a 50c one."

Aside from price and exchange rate considerations, other industry indications are good. Early summer rains have ensured a crop of normal proportions, with sugar production of around 2 Mt. The industry wrapped up last season with proceeds of R1 billion, leaving it with a small surplus over costs. As things stand, the current season looks like ending much the same way.

A formula has been devised through which a portion of the industry's surplus earnings will be directed at the repayment of its R327m debt. Sale, however, is reluctant to give details, saying the system is still to be refined.

With R80m in foreign loans which the industry has with overseas banks falling due at the end of the season, Sasa is clearly giving more attention to its debt position.

Sale was in London last week for his customary beginning-of-the-season visit. One of his tasks was to call on Sasa's bankers to assure them the debt repayment is in hand.

Of the R80m soon to fall due, he says confidently: "That portion which we don't succeed in paying we should have no problem in rolling over." ■

SUGAR

Price rise misfires

Optimism that the sugar price was set for a recovery this year seems to have been misplaced after touching US8c/lb in February, world sugar prices have drifted down to around US6,5c/lb on the major markets.

The South African Sugar Association (Sasa) was last week putting the best possible construction on the uninspired price movements. General manager, Peter Sale, was quick to point out that the current price was in line with last season's average of US6c/lb.

"Rather than talk about a decline in the sugar price," says Sale, "the line we prefer to

F 12/16/87

(3) Sugar

Sugar industry in dire need of help

3 SUGAR 18/6/87

Financial Staff

DURBAN — A bleak picture was painted yesterday of the current state of the sugar industry — and a call made on the oil industry to support an ethanol project.

Mr L Gordon-Hughes, chairman of the SA Cane Growers Association, said at the annual meeting in Durban that the sugar export market had been declining in importance. At the same time, problems had emerged in the domestic market.

The export market was inherently unstable and should not be regarded as a reliable source of income, he warned.

Its share of total industrial revenue had declined from over 40 percent in the mid-1970s to less than 20 percent in the past four seasons.

Increased export earnings in the year past were attributable to the weak rand rather than a higher sugar price. Much of this benefit had disappeared with the strengthening of the rand.

Indeed, more and more of the country's agricultural exports

were falling victim to the economy's increasing reliance on gold.

In the local market, rising input costs had resulted in annual increases in prices. This had led to consumer resistance.

Sugar — especially in the important industrial sector — was losing its near monopoly position and was being regarded more and more as one in range of sweeteners.

Mr Gordon-Hughes asked farmers to forestall possible labour disputes by sound labour management rather than by resorting to labour replacement through mechanisation. The consequences of such mechanisation would be disastrous to the socio-economic structure of Natal.

A welcome start had been made to repayment of the industry's R327 million loan burden.

The world stock position suggested there might be better prospects for more economic sugar export prices.

However a broad-based solution to the problems of the sugar industry — including an investigation into the potential of eth-

anol production — was necessary.

In his address, vice-chairman Mr Tony Ardington said average revenue per ton produced in the last season had been only 62 percent higher than that of 10 years earlier — compared with inflation of 264 percent.

Mr Ardington said sugar could be one of the most dynamic and important industries in the country — but at present it faced a steady erosion as it opted out of world markets and saw land taken up by more competitive crops.

Ethanol production would enable the industry to enter a market with tremendous potential growth in demand and earnings.

He said millers were increasingly supporting the concept.

A feasibility study had pinpointed location, size, capital costs and mode of operation of a plant but the oil companies were unenthusiastic.

He appealed to them to become part of the move to ethanol which would benefit thousands of small growers and provide rural jobs.

debt should be reflected debts will be contained within 1%

Transvaal Sugar very sweet

lifted by 4% to 29c (28c)

KAY TURVEY

IMPROVED agricultural conditions, better use of the sugar factory and higher average sugar prices have sweetened Transvaal Sugar Corporation Limited's (TSB) after-tax earnings by 83% from R8,2m to R15m for the year to March 31.

Turnover of TSB, jointly owned by Volkskas and Bonuskor, rose 16% to R121,2m with pre-tax earnings up 80% to R27,6m from R15,5m in the previous year.

TSB chairman Albert Marais predicts the agricultural sector will again make significant profit contributions this financial year.

Larger crops of sugar cane, citrus and sugarbeans are expected, and prospects are good if prices remain at present levels with no interruption of water supply.

An upward trend in the export price of sugar is expected, while it is important for the industry to stimulate the domestic market.

Diversification into sugar by-products remains a long-term goal, and expansion in their new stockfeed division is planned. The possibility of accommodating related products as part of the industry should be investigated, Marais says.

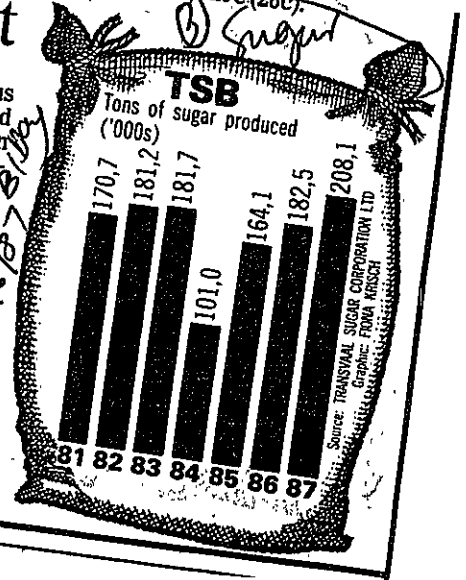

Poor outlook for sugar industry

③ sugar *Blair*
THE downward trend experienced by the sugar industry over the past five years is set to continue, with little respite in sight.

25/6/87
MICK COLLINS

And it is doubtful if any return on capital will be earned in 1987/88 because of low world market prices and provision having to be made for repayment of loans.

Addressing the Sugar Millers' Association AGM yesterday, chair-

man Kritzy Kritzinger said the 1986/87 season had been marked by the loss of the US and Canadian markets, and high inflation levels.

As a result of sanctions and other considerations, he said, it had been necessary to curtail and limit publication of the industry's marketing and production statistics.

John
- MIRENELLE
MICHELLE
André
4.50
4.50
48

W.P.S

Overseas competitors to the fore as sanctions leave a sour taste in SA's mouth

(3) Sugar

Sugar industry 'must continue to export'

IN SPITE of sanctions, which had hurt the sugar industry in the past year, the sector must continue to export to survive, SA Sugar Association (Sasa) outgoing chairman Kees van der Pol said yesterday.

He told the Sasa annual meeting he was well aware that some competitors were seeking to exploit SA's unfortunate situation. Van der Pol said: "It is, therefore, not surprising we have adopted a policy of limited disclosure on our affairs and this veil of secrecy applies particularly to all information from which the volume of our exports and their destination could be deduced." Regrettably, the 1986/87 season would be

MICK COLLINS [redacted] remembered as the one when the industry lost its markets in the US and Canada because of sanctions.

"Fortunately, we still have many friends around the world. People who are anxious to help, people who are firmly convinced that economic warfare is counter-productive in promoting reform away from apartheid." Van der Pol said destroying SA's economy would precipitate unfold hardship upon those least able to protect themselves. "The evidence of this is there for all to see in the increasing unemployment and the resulting desperation among the younger generation."

Van der Pol said the industry was faced with the primary task of protecting those already in it, and the conversion of some of the export surplus to fuel alcohol would be a possible solution.

It also had a great capacity for creating jobs and for increasing the earning capacity of black peasant farmers. He said: "But this would mean expansion of the industry, a risk we cannot take in the face of a distinct possibility of increased difficulties to our export market." The fuel alcohol matter was receiving the serious attention of the industry and it was an extremely complex one.

● See Page 6

DURBAN — The possibility of a sugar-based ethanol industry in Natal rested on government making a strategic decision nationally, Sasa vice-chairman John Chance said yesterday. He said the industry had the technical expertise and resources and the oil industry could blend the fuel with petrol.

But government had to be the "ultimate arbitrator on the price we must receive for our ethanol in the light of the overall national interest and based on present day petroleum prices". Chance hoped the oil industry was reluctant to use ethanol and would certainly not "foot the bill for any socio-economic or strategic advantages that may enter into the price determination".

Pick-up at last

It was a dizzy slide from the earnings peak of 119c a share in 1984 to 24c in 1986; so even last year's 3,5 times growth still leaves earnings well off the top in nominal terms, and even more so if adjusted for inflation. Still, at least it's a move in the right direction.

Tongaat benefited from both a cut in the interest charge (which, in 1986, absorbed 73% of the operating profit) and better trading results in every division except sugar, which was hit by drought and Eldana borer. The biggest turnaround was in textiles, from a R1,6m operating loss to a R14,5m profit.

Chairman Chris Saunders says the R118m cut in borrowings was achieved by careful control of working capital, improved earnings, and the change in the Sugar Association's year-end.

The sugar division remains the largest in the group and the biggest sugar operation in SA. Total industry output fell, as did the division's share. Improved export prices were insufficient to offset this. The division ex-

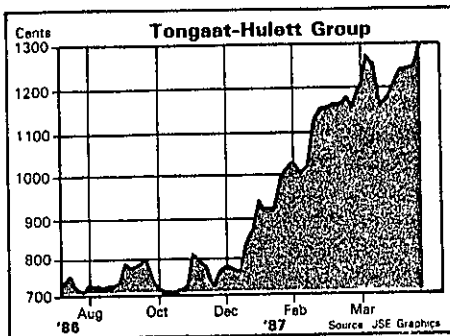

Handwritten: 24/7/87
3) Sugar

pects higher output and a higher industry share this year. Domestic offtake seems to be improving and though the recovery of the rand will hit export proceeds, the division's pre-tax profits should improve. However, so will the incidence of tax, so at the net level

Activities: Holding company with seven operating divisions: sugar, building materials, foods, aluminium, textiles, starch and sweeteners and industries.

Control: Anglo American holds 20% and Amic 23,5%.

Chairman: C J Saunders; **managing director:** T G Cleasby.

Capital structure: 73,5m ords of R1. Market capitalisation: R1,1 billion.

Share market: Price: R14,75. Yields: 2,3% on dividend; 5,8% on earnings; PE ratio, 17,4; cover, 2,5. 12-month high, R14,75; low, R6,90. Trading volume last quarter, 2,1m shares.

Financial: Year to March 31.

	'84	'85	'86	'87
Debt:				
Short-term (Rm) ..	85,3	161,4	146,3	79,3
Long-term (Rm) ...	310,3	365,3	352,4	301,5
Debt:equity ratio	0,52	0,64	0,61	0,45
Shareholders' interest	0,52	0,50	0,50	0,53
Int & leasing cover ..	3,7	1,7	1,3	2,3
Debt cover	0,38	0,21	0,16	0,34

Performance:

	'84	'85	'86	'87
Return on cap (%) ..	10,8	10,8	8,3	11,1
Turnover (Rm)	15,5	1804	1848	2 177
Pre-int profit (Rm) ...	159	176	136	177
Pre-int margin (%) ..	10,1	9,4	7,0	7,9
Taxed profit (Rm)	100,3	55,8	24,7	67,1
Earnings (c)	119	60	24	85
Dividends (c)	58	30	12	34
Net worth (c)	942	1 012	1 035	1 082

little change is expected.

The building division's marginal profit improvement reflected slack demand. It operated at only 60% of capacity. In spite of the uncertain immediate outlook, black housing programmes should be beneficial.

The food division generally did well, though there were problems with mushroom production and fierce competition in edible oils. A recovery in some local market sectors, and the benefits of rationalisation measures implemented in recent years, helped aluminium boost its profit contribution by R9,5m. Rationalisation and strong demand were also the key to the turnaround in textiles.

Starch and sweeteners enjoyed a 17% growth in sales volumes. Coupled with successful cost containment, this resulted in a significant profit improvement. The industries division sold all except its specialised haulage activities.

Except for the reservations on sugar and building materials, all divisions are looking for a better year. Saunders adds that debt containment will remain a priority, despite increasing capex (budgeted at R70m, mostly on renewals and replacements) and working capital requirements. So the interest bill could fall again.

Earnings last year were at the top end of, but just within, analysts' forecast ranges. Reviewing the interim report in November,

Tongaat's divisions

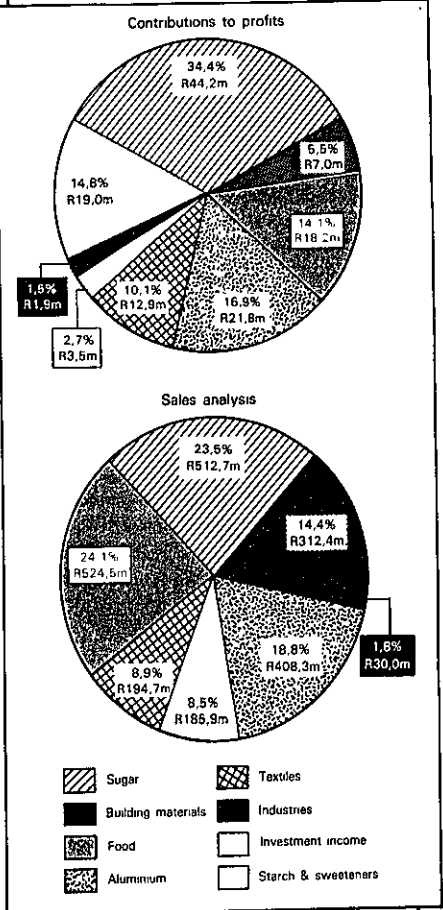

the *FM* suggested earnings might be 82c; if so, the price (then 790c) "could maintain its upward trend." It sure has, with an 87% gain, against only 45% by the industrial index over the same period.

This year, some analysts are looking for earnings of 120c, a prospective p/e of 12,3. That could permit distribution close to 50c, to yield just over 3%. Rationally, that may not leave much room for further advance; but the share seems to have regained market favour, and in current conditions that could keep it running.

Michael Coulson

Bitter blow for SA sugar producers

*3 Sugar Bldg
27/7/87*

SOUTH AFRICAN sugar producers were dealt a further blow at the weekend by forecasts of a rise in world sugar production in the 1987/88 season.

Statistics released by the US Agriculture Department point to a growing sugar mountain and suggest a new record of 102.4-million tons will be set. Asian production is expected to rise by 5%, North American by 3% and South American by 2%.

Only the EC, Africa and Eastern Europe are expecting lower levels. The local industry is already beset by sanctions, low world prices, a shrinking

domestic market and the ongoing battle with oil companies over its proposed ethanol production.

The domestic market has seen annual consumption drop from the 39kg per capita level in 1976 to 32kg for the past season.

The news follows hard on the heels of a survey which suggests no improvement in world prices (\$0.06-a-pound) for raw sugar while any surplus lasts. Some

MICK COLLINS

industry experts have forecast a modest rise to the \$0.08-a-pound level but feel the level will be short-lived.

Production in the US is expected to reach 6.7-million tons for the 1986/87 season, up 11% over the previous year and the highest since 1975/76.

Chairman of the SA Sugar Association (Sasa) Kees van der Pol says local producers cannot expect a dramatic recovery in world sugar consumption and the structural changes needed to reduce production are unlikely to occur easily.

Addressing delegates at Sasa's AGM, Van der Pol pointed to the difficulty of reducing production without precipitating a major socio-economic crisis.

"World markets can no longer absorb the over-capacity of the developed world's agricultural sector."

"The desire for self-sufficiency and the policy of keeping the farmer on the land has resulted in huge surpluses, both in the production of dairy products, grain products, meat or sugar."

FM 31/7/87

sugar prices, at US6c-7c/lb (for spot raw sugar, New York), are now holding well above the lowest levels of less than US3c.

The projection underlines the continuing problems faced by the world's sugar planters. Over the past six years, they have not only seen sugar prices drop to the lowest level ever in real terms, they have also suffered intensified competition for alternative sweeteners and watched negotiators fail to reach an international sugar agreement.

According to Du Genestoux, "unrestrained optimism" stemming from a feeling that a price upsurge has started "will jeopardise or even suppress the expected boom."

"Each year the basic statistical situation shows an improvement," he says. There could be a move towards more satisfactory price levels. But world production has to drop "by a few million tons."

Du Genestoux, in cautioning against optimistic interpretations of recent price trends, offers a revealing analysis.

He acknowledges that the world surplus, though it has only halved from 12 Mt in 1983 to 5 Mt-6 Mt, is not excessive, since it represents less than three weeks' world consumption — not much different from periods when prices were beginning to pick up.

He also accepts that, in terms of exports, the surplus of 2,5 Mt — equivalent to five

weeks' exports, of which two-thirds is held by the European Economic Community (EEC) — is encouraging in as much as the surpluses of non-EEC countries have been swept away and the EEC itself could, if it wished, withhold stocks and finance them.

But in his view the stage is not set for a rise in prices, because world production is not, as in previous instances, about to drop. While the white sugar market remains solid, with many buyers and few sellers, the raw sugar market underlying it is sick, he says.

Of the two major buyers of 10 years ago, the US has almost halted its intake while Japan has cut imports. A new buyer, Russia, is neither a regular nor a growing one.

The "practical conclusion," Du Genestoux says, is that all available means should be used to halt the continual growth in production capacity — in fact, to reduce production by 6 Mt-8 Mt. This is not much compared to world output of 100 Mt, but represents more than a third of free market turnover.

A further requirement, he indicates, is a reduction in protection. Producers have a choice between maintaining the status quo — meaning lower sales, a halt in consumption growth and the disappearance of the world sugar market — and lower domestic prices, which will lead to increased sales and higher average world prices longer-term. ■

SUGAR

(3) Sugar

Words of warning

World sugar prices are not about to rise and will only increase if world production is cut, despite statistical signs of improvement. This sombre forecast was given delegates at the third conference of world sugar farmers, held near Brisbane, Australia, recently.

It came from Patrick du Genestoux, chief economist of Ersuc, the Paris commodity trading house. He offered it even though

Increased output maintains mountain

Little stirring is likely in world sugar price levels

b/day

3 Sugar

WITH the world sugar mountain refusing to melt, producers have been cautioned that price levels are expected to remain stagnant with little improvement expected in the near future.

The SA Sugar Association (Sasa) says the latest estimates of production during the 1986/87 year, which ended on August 31, show an increase of 3-million tons is expected, compared with 1985/86, and this will keep the mountain pegged at around 102 tons.

"This increase is considered large enough to prevent a significant reduction in world stocks and will forestall a movement in prices to higher levels."

Bad weather in major producing countries could improve the balance, but Sasa says, this aside, and taking into account a modest increase in consumption which could decrease stocks by one or two-million tons, world stocks will remain at about 30% above consumption.

Meanwhile, officials from the world's leading sugar importing and exporting nations held a four-day conference in London last week on a proposed new International Sugar Agreement.

The proposed pact, like the one expiring at the end of this year, would have no powers to regulate supplies and prices.

Industry sources said adoption of a new International Sugar Agreement would ensure continuation beyond the end of this year of the International Sugar Organisation as a body for market

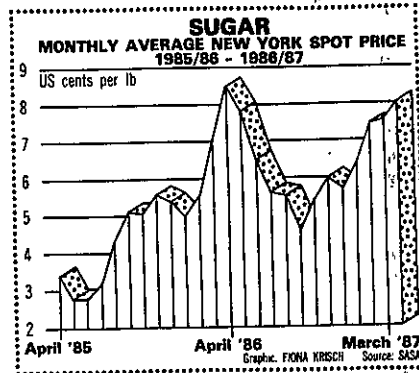

studies and statistical work.

Conference delegates said the main difficulty over drafting the agreement, the sharing of administrative costs, had been largely resolved. The 12 importers involved, which included the US and the USSR, would contribute 40% and the 44 importers 60% percent.

The last pact with such powers expired at the end of 1984, after which the market plunged to below three US cents a pound — its lowest level ever in real terms.

Although prices have since recovered, as the huge world surpluses that plagued the market in the mid-1980s have been reduced, the price is still about half the average world production cost of 12c.

The search for a new pact with regulatory powers was abandoned earlier this year because of differences among the leading exporting countries.

G. J. J. J.

Poison spraying: Babies 'deformed'

CONCERN is growing in Natal that an insecticide being sprayed on sugar-cane plantations in the province may be responsible for the spate of deformed babies born over the past six weeks.

In the month of August alone 13 deformed babies were born at Durban hospitals.

An independent pressure group, the Chemical Watch Action Group, recently formed to monitor possible links between chemicals used and deformed babies, has received over 300 reports of deformed babies.

Ninety-eight percent of the cases reported, even those from as far as the

Transvaal, had links with Natal. Most of these deformed babies were conceived in spraying season.

The chemical substance being sprayed on the sugar-cane plantations, 24d and 245t, which have caused the widespread concern, have been banned in many parts of the world. However, it is extensively used in the sugar and timber industries in Natal.

Mrs Kay Channing Pearce, chairperson of the action group, reported that last year a large consignment of double-strength 24d herbicide, was bought by a Natal farmer and used in extensive spraying operations.

"We find this extremely alarming. It

is illegal to have this substance on the open market. It has no labelling and no instruction," said Pearce. From its investigations, the action group has produced a frightening dossier linking chemicals with deformities and other health problems.

Among the cases reported were:

- A baby born in Westville, in Natal, three weeks ago, without an eye or brain. The baby died half an hour later.

- A mother from Umhlanga, also in Natal, reported that she had conceived four times. Two babies, conceived in winter, non-spraying months, were normal. The two conceived in the

spraying season were not. The one died of unknown causes at the age of six months; the other died in the late foetal stage.

- A baby was born in Johannesburg with the lower part of the legs deformed and two toes missing. The father was a fertiliser salesman and visited Natal agricultural areas twice a season, particularly in the spraying season.

- Another Johannesburg mother gave birth to a baby girl with lower limb deformities. The mother had visited Natal in the early part of her pregnancy during the spraying season. Dr Priscilla Tryer, Natal director of

the Department of National Health and Population Development, described the whole business as a "storm in a tea-cup".

"I am certainly not convinced we have an epidemic on our hands. And we have not launched an investigation yet," she said.

Mr Peter Sale, general manager of the South African Sugar Association, said there was no move to abolish the use of the herbicides 24d and 245t.

He said, however, the association would be prepared to co-operate in investigations that would help to solve the issue. *P. J. S.*

Big world sugar output hits prices

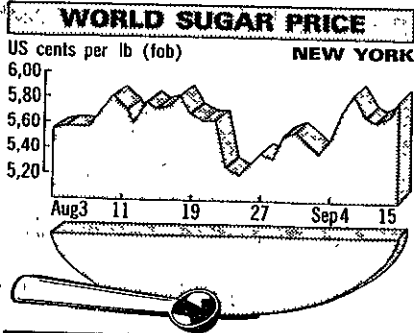

Source: SA SUGAR JOURNAL Graphic: JOHN McCANN

THE outlook for higher prices for SA sugar exporters is poorer following revised higher world output figures.

Prices for the 1987/88 season are now expected to average between eight and US9c a pound which is still slightly up on the 6,2c in the 1986/87 season, says the SA Sugar Association (Sasa).

"The Bureau for Agricultural Economics said that higher than expected world sugar output has reduced the likelihood of significant price rises," says Sasa in its latest Sugar Journal.

"World sugar production in 1986/87 is now estimated at a record 104,1-million

MICK COLLINS

tons, up 5,4-million tons from a year earlier."

During the August/September period the spot price (see graph) fell to a 12-month low of 5,19c on August 26. Since then, good trade buying, spurred by rumours that Russia was about to enter the market has improved matters.

The market also rallied on news that Cuba would be unable to supply sugar to Japan in early 1988. However, this has been held in check by producer pricing — mainly by Brazil and Cuba.

(3 Sugar) B/dwy 15/10/87



B/day 16/11/87 3 SUMME

Outlook for sugar is bright

THE OUTLOOK for world sugar markets continues to improve and is reflected in the sudden jump in futures prices which, for much of the past year, have languished in the doldrums.

Prices look set to pursue a significant upside run on account of substantial changes in global output and consumption.

ED & F Man, an established sugar trading company in London, foresees a considerable 1.2-million ton fall in European sugar beet output and, combined with production problems in China and India, now forecast that the overall annual deficit for the year could well exceed 750 000 tons.

Marked

This forecast revision is in marked contrast to earlier reports which suggested that once again production surpluses would weigh heavily on prices and add further to the problem of existing stock-piled sugar.

Russia has been in the market for some 500 000 tons of raw sugar in recent weeks which possibly reflects Cuba's decreased production and China, the sur-

Holcom Futures analyst CHARLES JOHNSTONE takes a look at recent activity in the commodity markets

prise of the pack, reportedly purchased 400 000 tons which would seem to confirm the drought in the Far East this year has been a major one.

The sugar price for March delivery has risen to US7.90c a pound, up from a low in September of US6.50c a pound.

While the current run in prices is unlikely to hit those astronomical peaks of US45c achieved in 1980, higher levels through the first quarter of 1988 than those indicated, are now anticipated, possibly reaching 14.

While on the subject of soft commodities, the soya bean complex is coming to life.

Again it is the Russians that appear to be behind it, purchasing 400 000 tons of beans and 300 000 tons of meal from US exporters.

Prices have risen some 14% in the last three months with potential for further gains.

While the dollar is as low as it stands now, American export operators are facing increased enquiries for agricultural produce; indeed at current price levels it might make sense for net importing countries to consider buying excess and stockpiling.

Copper has pursued its relentless upward surge of last week attaining prices up to \$2 600 a ton (highest since 1980), fluctuating wildly on an intraday basis in ranges of up to \$150.

Prepared

Nobody seems prepared to forecast the upside potential in the short-term but most dealers feel that by the end of the first quarter of 1988 an element of normality should have returned to the market and spot prices should fall back.

London Metal Exchange warehouse stocks are standing at an unprecedented low level of 59 700 tons reflecting the tightness in the market.

When these stocks begin to rise, operators believe this will be indicative of the squeeze ending.

A dangerous and formidable market for speculators, but for the producer these levels must surely provide ideal hedging opportunities.

MICK COLLINS

SQUEEZED by US sanctions and shrinking local consumer demand, the sugar industry desperately needs government's green light for its R70m ethanol distillery at Richards Bay.

In the past year the sector has battled to cope with sanctions legislation in the US and Canada which led to the loss of markets for more than 150 000 tons of sugar. Added to this, the local market has been beset by the "slimming" problem which has caused thou-

350994

B/daw 18/11/87

Sugar depends on govt decision on ethanol

sands of traditional consumers to turn to artificial sweeteners.

The envisaged enforced reduction in the crop of nearly 200 000 tons of sugar a year would, the industry says, bring unfold hardship for farmers, loss of jobs and a further labour drift to the cities.

The ethanol plant, which could be brought on stream within two years, would use nearly 200 000 tons of export sugar and 150 000 tons of molasses to produce about 150-million litres of ethanol a year.

SA Sugar Association (Sasa) chairman John Chance says the industry has a heavy investment in milling capacity and most of about 25 000 farmers are totally dependent on sugar.

"On a wider field, we provide directly or indirectly for the support of around 1-million people in the most heavily populated rural area of the Republic."

The most important step in the planning process for the distillery was to ensure ongoing security of supply.

The productive capacity of the sugar industry is currently such that in both the unprecedented floods and droughts of the past six years it could easily have provided for the full consumer requirements and the full ethanol commitment to the national fuel pool," he says.

ETHANOL FROM SUGAR

A sour note

Government's task force inquiring — behind closed doors — into the merits of an ethanol plant for Natal (*Leaders* August 14), owes taxpayers a crucial disclosure.

Converting molasses to ethanol to blend with petrol is not justified by normal economic or commercial considerations. Prices struck with oil refiners would be below production cost, and hence waste the investment.

The SA Sugar Association (Sasa) admits as much. But precedents for social and political engineering abound in SA's over-managed economy. And sugar's ethanol lobbyists, headed by former Sasa president Kees van der Pol, argue accordingly.

By the sugar industry's calculations, jobs are created by the State at the Natal decentralisation point of Isithebe at a capital cost of R40 000 each and an annually recurring cost of R2 500. By contrast the R80m ethanol plant proposed for Richards Bay will secure 20 000 jobs now at risk in the sugar industry, at a *per capita* cost of R4 000.

The need for aid in establishing an alternative market, Sasa says, arises from sanctions, the plunge in world sugar prices — from 40c/lb-7c/lb over the past seven years — and the politically unacceptable response to shutting down large sectors of the industry.

In addition, the 150 Ml of ethanol produced annually would add to SA's fuel self-sufficiency, albeit marginally. It would save foreign exchange; allow a uniform fuel pool throughout the country; and contribute towards stability in a politically troubled region.

The argument sounds a familiar refrain: pressing social objectives and a hostile international climate oblige government policymakers to reward job creation, regional economic development, foreign exchange savings, strategic industries, and domestic self-sufficiency by way of State incentives and subsidies.

"All we ask," appeals Van der Pol, "is that we should be treated no differently from everybody else."

Regrettably, sugar men decline to enlarge on their second line of defence, namely that the subsidy government will have to add to the price oil refiners are willing to pay for ethanol will be relatively small.

Ethanol is already produced in SA for industrial consumption. Currently molasses, a by-product of sugar manufacture, is converted into rectified spirit, or ethanol. Production cost of the spirit, the *FM* reliably understands, is 49,85c/l.

This cost price contrasts with the in-bond landed cost or "reference price" for fuel, currently around 35c/l (a weighted average price of 93 and 98 octane). Thus a difference, or shortfall, of 14,85c/l.

Sugar men claim that ethanol's octane enhancing properties should command a premium on the reference price, particularly since lead, employed as an octane booster, is being legislated to lower levels. If this were adequately rewarded by refiners, the plant would become viable with only a small contribution from the State in the form of incentives and rebates similar to those already enjoyed by Sasol as a producer of indigenous fuels. This it believes to be around 10c/l.

Oil men argue that ethanol's octane boosting properties are minimal, that refiners need compensation for lost throughput, and that further costs will be incurred to produce a new blendstock to which the ethanol may be added.

Sugar men believe a new blendstock would



Pressing for sugar to fuel

be cheaper to produce since it will be a lower octane fuel. They point to Zimbabwe, which imports 93 octane fuel and blends this with 12%-15% ethanol to produce 98 octane fuel. But their argument is likely to fall on deaf ears as the refiners claim this leads to an inferior product which performs poorly at high speeds. As final marketers of the new product, this is a risk they are unwilling to bear.

The upshot is that the oil refining industry has offered to buy ethanol at a discount to the average fuel reference price of 35c/l. Nobody is saying how much lower this is, but one refiner's figures even suggested early in the negotiations that he should be *paid* to add ethanol to his product.

The gap between what the oil industry is willing to pay and the sugar industry requires for viability may thus be anything from a bare minimum of 14,85c/l on production costs and rising. At the lowest level, and based on production of 150 Ml, closing this gap will cost the taxpayer R22,3m — and it could be more than double this.

This adds a considerable recurring bill to operating costs and makes it impossible to take a final view on the socio-economic arguments without further detail. If the country must accept that its economy needs to be managed in defence of international political strategy and to achieve social objectives, taxpayers are at least entitled to know the cost.

KM 25/12/87

SUGAR - 1988

Sugar price rise 'a big blow'

Star 30/1/88 (3) Sugar
The new year's sugar price increase will force up the prices of a wide range of foods and beverages but retailers have promised to absorb these increases for as long as possible.

The South African Sugar Association announced yesterday that sugar would go up by 7 percent on February 1 and a further 4 percent in August, a move which retailers and consumer organisations say is "regrettable" particularly as the increases will have a ripple effect.

Mrs Lyn Morris, president of the Housewives' League, pointed out that many canned products

would go up in price as a result. "People tend to think only of the biscuits, sweets and jams that will be affected, but many canned foods contain sugar and these will go up in price too," she said.

Mr Richard Cohen, a director of the Pick 'n Pay supermarket group, said it was a pity consumers had to start the new year with an increase of such proportions.

A director of buying for Checkers, Mr Paul Susan, said the supermarket chain would be buying up as much stock as possible to keep the sugar price down.

TONGAAT-HULETT

Sweeter prospects

3) sugar

Activities: Group operates in sugar, building materials, foods, aluminium, textiles, starch, sweeteners and transport.

Control: Anglo American holds 20% and Amic 23,5%.

Chairman: C J Saunders; managing director: T G Cleasby.

Capital structure: 73,5m ords of R1. Market capitalisation: R889m.

Share market: Price: 1210c. Yields: 4,5% on dividend; 13,4% on earnings; PE ratio, 7,5; cover, 3. 12-month high, 1650c; low, 925c. Trading volume last quarter, 1,6m shares.

Financial: Year to March 31.

	'85	'86	'87	'88
Debt:				
Short-term (Rm) ..	161,4	146,3	79,2	63,5
Long-term (Rm) ...	365,3	352,4	301,5	241
Debt:equity ratio	0,64	0,61	0,45	0,32
Shareholders' interest	0,50	0,50	0,53	0,54
Int & leasing cover ..	1,7	1,3	2,41	4,27
Debt cover	0,21	0,16	1,64	3,28

Performance:

	'85	'86	'87	'88
Return on cap (%) ..	40,8	8,3	11,2	14,3
Turnover (Rm)	1 804	1 848	2 177	2 622
Pre-int profit (Rm) ...	176	136	176,9	240,9
Pre-int margin (%) ..	9,4	7,0	8,1	9,2
Taxed profit (Rm)	55,8	24,7	62,0	124,8
Earnings (c)	60,3	24,4	85,3	162,2
Dividends (c)	30	12	34	54
Net worth (c)	1 012	1 035	1 081	1 189

Sweet times have returned for Tongaat-Hulett, thanks partly to the booming international sugar price. But sugar will not alone produce the substantially higher earnings expected from the group this year. While sugar's contribution to group profits will increase from last year's 25,8%, substantial increases in contributions from the aluminium (20,3% last year) and building materials (9,6%) sectors are also expected.

The international sugar price, combined with the fallen rand and expanded production after a good rainy season are bullish for the outlook. But 60% of the group's production is sold locally, where the controlled price is normally increased once annually and that has already taken place. The contrast between the State President's call for price restraint and the high international price makes the amount of the next domestic increase uncertain. And, while income from sugar will in any case be much higher, some of these revenues will go towards reducing debt in the industry price stabilisation fund, which sank deep into debt of R320m in 1983-1984. The industry will pay R120m into the fund this year, but Tongaat-Hulett's contribution is not revealed.

Aluminium product sales are understood to be particularly strong, despite the higher costs of imported raw material to Alusaf. A new re-melt furnace was commissioned last

year to relieve a shortage of scrap recycling capacity. This year, two more furnaces are being built. To meet the increasing demand for aluminium sections, an outdated 2 000 t capacity extrusion press is being replaced by a new, 3 800 t unit costing R15m.

The building materials division recovered somewhat after four years of recession. The recovery should gather further momentum this year, benefiting especially from the long-awaited black housing upswing. Toncoro says demand for bricks has increased dramatically in the low-cost housing sector. The much-vaunted informal sector has become a major customer, and new depots are being located to take best advantage of this. At year-end, 36 factories were operating and six remained mothballed, but the latter are being reopened or partly reopened.

The textiles division has recovered strongly since 1986, when it made losses, but markets have been eroded by competition from cheap imports. The investigation by the Board of Trade & Industries into the textile industry continues, but the delay is making it difficult to develop competitive strategies. Exports are down this year, especially in denim, which has been hit by the "vagaries of fashion," according to the annual report.

Margins in the food division remain the lowest in the group, but the division hopes to increase profitability through improving efficiency, productivity and marketing. Other divisions — starch, sweeteners and transport — are also likely to show relatively dull growth.

The group has recovered well from the

ed. Its historic p/e of 7,5 is in line with that of Amic and compares with 4,4 for Federale Volksbeleggings and 6,2 for Barlows. The portfolio justifies the relatively high rating for long-term investors, but most of the immediate recovery is probably already in the price.

Teigue Payne

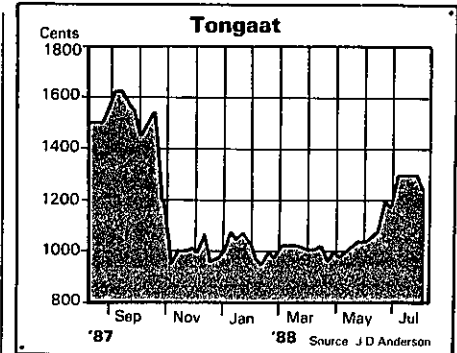

disastrous level to which it declined in 1986, when EPS sank to 24,4c. At year-end the debt:equity ratio was at a five-year low and dividend cover was increased to three times. Management is optimistic about the current year, but does not venture specific forecasts. Last year's 90% EPS increase would be hard to repeat and some analysts are expecting 40%, to about 225c a share, which would move it to a forward p/e ratio of 5,4.

The divisions are diverse, but they operate largely in areas of basic need, such as food, clothing and shelter. Effectively, this means they derive much of their strength from the black market. The share is not a rand hedge, but significant exports — in more than one division — more than compensate for the higher costs the group is incurring for imported capital goods.

Although the group has a conservative, even colonial, image, it enjoys a high rating at present compared with other groups, indicating that further strong growth is expect-

More than sugar

Contribution to profits 1988

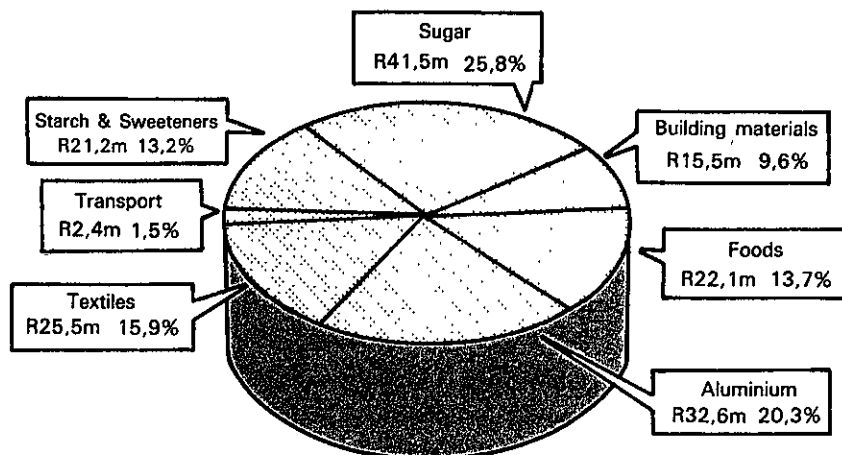

Hit-or-miss Sugarbush for the JSE

By Julie Walker

SUGARBUSH exploration company, controlled by Golden Dumps, is to be listed on the JSE.

Unlike other exploration companies which offer a portfolio of mineral rights, Sugarbush has a single target area and will be a hit-or-miss project.

An area of 33 000 hectares is under option to the company. It lies between the south-eastern corner of the Evander goldfield and the north-western edge of the fledgling South Rand basin.

Previous geological interpretations suggested that the Evander field was terminated at its southern edge by the Sugarbush fault, but Golden Dumps investigations have shown this is not the case.

Geophysical techniques, such as vibroseis, have produced results which enabled Golden Dumps to develop a model of the region. It is probable that the fault swings northwards along the western edge of the Evander

field. 3/7/88
Geologists at Sugarbush have identified the Kimberley Reef as the major economic target. The area is likely to be faulted, but it is not expected that areas of mineralisation will exceed a depth of 2 000 metres.

Golden Dumps is in good company in its geological expectations. Two major mining houses are also active in the area.

Yes or no

Three diamond drilling rigs are operating in the area. Golden Dumps needs R26-million to fulfil its drilling programme, and is inviting the public to take part at the outset.

An exploration company is a speculative investment, but Sugarbush offers a yes or no outcome within two to three years.

The raising of capital will be in two stages. An initial R16-million will be sought through a rights offer and the other R10-million will be raised by options. Details will be published in the Sugarbush prospectus in the next few days.

Ethanol 'better prospect for SA sugar industry'

Own Correspondent

DURBAN — Increasing sugar exports carried too many risks, but ethanol and down-stream chemical production would provide a secure and rapidly growing outlet for sugar products, SA Sugar Association chairman John Chance said yesterday.

Construction of an ethanol plant in Natal would also help solve one of SA's major problems — the rush of people to the cities — and would form a bulwark to the increasing clamour of countries that would refuse to buy SA sugar.

It would also tackle a problem SA ignored — atmospheric pollution, Chance said.

America and France had made it possible for increasing volumes of ethanol to be used in cars while SA spent its sparse capital resources on pollution-creating, non-renewable sources of energy.

3 SUGAR B/ dww

28/7/88

Sanctions could devastate country's cane belt

29/7/8

By Dave Canning
DURBAN — The sugar industry and large parts of Natal and the Eastern Transvaal — would be disastrously affected if the current clamour for sanctions was successful, Mr John Chance, chairman of the SA Sugar Association, said yesterday.

Making another plea for a positive Government decision on the proposed ethanol plant for Richards Bay, he told the association's annual meeting in Durban: "The clamour for more stringent sanctions to be applied to our country grows louder by the day. Sanctions, if applied successfully, would undoubtedly have a disastrous effect. It would cause the closure of some mills, and

untold hardship to some employees and cane growers — particularly black growers. More than 750 000 blacks were dependent on the industry. Many towns throughout the cane belt would suffer. Satellite industries would be badly affected.

He said the Government had been made aware of the catastrophic effects on Natal and the Eastern Transvaal should sanctions threats become a reality. "We can only hope that political solutions to our country's difficulties will be resolved before any such actions take place."

An ethanol plant could materially assist in stabilising the economy of the sugar industry

and he hoped the Government would take a final positive decision soon.

He did not believe that the Government, which spent billions of rands on capital intensive non-renewable synfuel plants which create major pollution problems, could continue to ignore precedents in a number of leading countries which are diversifying agriculture into ethanol fuel production.

He said the sugar industry's attempts to diversify into ethanol could be jeopardised by vested interests present at various stages of evaluation of the project.

A secretive "black box" approach had been adopted in re-evaluating the ethanol feasibility

study, first by the oil industry and then a select sub-committee of the National Energy Council.

"The sugar industry does not query the State's expenditure on strategic indigenous fuels but I believe we have a right to receive similar treatment and to know what parameters are used to evaluate our ethanol project."

The better outlook had enabled the industry, in April, to repay R40 million of the R327 million in loans raised earlier this decade.

By this time next year the sugar industry could be in the fortunate position of having repaid at least half of its total loans.

Mr Chance said the association had generated a profit of

R15 million from transactions covering the flow of export proceeds. No foreign exchange losses had been experienced on foreign currency loans which had been raised.

However he sounded a warning about SA's position as a major exporter and also warned against thoughts of expanding the industry in general.

The world free market was unlikely to become profitable — except for temporary surges as at present — until the US and EEC changed their agricultural policies.

There were signs that they were beginning to rethink their policies. However it could be 10 years

before agricultural trade barriers and protections were removed completely, if at all.

● Sapa reports from Port Louis that the United States is to buy more sugar from Mauritius this year.

The island says that Washington will purchase just over 12 000 tons of sugar, which represents an increase of 4 000 tons in the US annual quota from Mauritius.

The US has increased its quota this year because it will have to buy 300 000 tons more this year due to acute drought prevailing there.

The sale of the 12 000 tonnes will earn Mauritius about \$12 million.

STAINLESS STEEL

Fabricating a better future

The R600m-a-year stainless steel fabricating industry plans to become one of the country's major industrial growth areas within the next few years.

Local sales are booming and international stainless steel demand is on an unprecedented upward surge, prompting primary producer Middelburg Steel & Alloys (MSA) and the Board of Trade and Industry (BTI) to support a strong export drive.

The reason is obvious. While 50 000 t of MSA's primary stainless steel production is now exported at an average price of R7 200/t, downstream fabricated earnings could be as high as R25 000/t.

"The fabricating industry has an enormous potential, based on an expanded export market," says MSA MD John Gomersall.

SA's primary stainless steel can be sold into only 15% of countries constituting the 9 Mt/year export market, but fabricated products could gain entry into 85% of world markets. SA produces only 1% of the world's fabricated stainless steel products, but 48% of its ferrochrome — a basic ingredient of stainless steel.

MSA is pushing for a fivefold increase in stainless steel production — to 500 000 t — by the year 2010. Gomersall says it is "not inconceivable" that the capital investment required could total R500m over the next five years.

The current 280 000 t/year ferrochrome capacity is first in line for expansion. A figure of around R130m — at both the Middelburg and Krugersdorp plants — has been mentioned. But Gomersall says it's too early to make a firm announcement.

"On the stainless steel side — currently running at full capacity at 100 000 t/year — we are looking at a de-bottlenecking operation which could considerably expand productive capacity. On the hot-rolling side alone, we can expand production to 200 000 t/year, while at the same time doubling casting capacity," he says.

Based on strong growth in the international stainless steel market, Samancor's ferrochrome exports have also surged.

"Our new 60 000 t/year plant will be commissioned next year, pushing up total capacity to 480 000 t/year. Over the past year, world prices have surged 45%, from US40c/lb to 58c/lb. World stainless steel sales jumped an unprecedented 13% from 1986 to 1987, compared with a previous average of 3%/year. The outlook remains bullish," says Samancor chrome division GM Ralph Schroder.

But while the signs are encouraging for local fabricators getting into new export markets, sharp price competition from cost-

effective Far Eastern competitors — especially South Korea and Taiwan — is currently keeping many of them out.

One problem is the "insular" approach to exports. Better local sales — up 10%-25% on last year — have meant unused capacity is being taken up to meet local demand. Exporters are also dissuaded by the prohibitive capex involved.

Help, however, is at hand. The MSA and the 150-member Southern African Stainless Steel Development Association (Sassda) are seeking to promote and identify export opportunities. Moreover, the BTI confirms the stainless steel industry has been singled out as a candidate for targeted export assistance.

Though the BTI initiative is still at an embryonic stage, Sassda says it wants to build up export contacts into Africa — SA's "natural" export market.

"Central and West African states are obvious markets. With Africa's massive population growth, opportunities will arise for stainless steel application in food hygiene areas like dairies, kitchens, and even breweries, petro-chemical plants and others. We are in constant contact with many of these countries and I see great things ahead for local fabricators," says Sassda marketing director David Tweddell.

Jobbers say there are tremendous opportunities in mining and other fields in Africa, but that politics creates stumbling blocks. ■

7c/lb last year. The international sugar stockpile is declining and consumption, particularly in SA, is rising.

On top of that, SA's sugar growers ended the 1987/1988 season in March with a better-than-average crop. Good summer rains augur well for the current season, with some growers anticipating an excellent crop by the time mills close in March 1989.

The industry no longer puts out figures on the division of proceeds at the end of the sugar season — mainly because of market sensitivity to the threat from international sanctions.

But the FM understands the small surplus shown was sufficient to make a R40m payment towards redeeming the industry's mountainous R327m debt.

If the current price scenario holds firm — more optimistic market watchers actually believe prices could reach 12c/lb by year-end — this season's proceeds should be sufficient to make a further R40m dent in the debt burden, bringing the total debt down to R247m.

Sugar Growers Association chairman Tony Ardington says growers have not been in such an encouraging position for many years. He ascribes the changed sugar market mainly to the fact that the international stockpile has fallen from 40% of total annual consumption to around 30%. This is due to a steady 1,5% rise in consumption over supply — a trend which should continue. There has also been a sharp rise in South African domestic consumption as a result of the more buoyant economy.

The increase in domestic sugar consumption is currently running at around 5% a year compared with the three-year moving average of 2,5%. This is principally due to more vigorous marketing by the South African Sugar Association (SASA) and a series of below-inflation domestic price increases.

Internationally, the news is equally pleasing. SA has not lost any more export markets after being squeezed out of the US, Canada and Philippines by the sanctions lobby. But industry sources remain cautious — especially in regard to Japan.

SASA GM Peter Sale says if the trend in both domestic and international markets continues, farmers should also be able to make some inroads into their personal debt position — considered parlous in many instances — through the higher sucrose price likely to be paid this season.

However, Ardington warns that any further increases in interest rates would immediately "wipe out any prospect of farmers seeing an improvement in their indebtedness this year." ■

SUGAR INDUSTRY (3) sugar

Sugar gets more 'go'

Good news has been hard to come by for SA's sanctions-prone sugar industry. At last it appears some relief is in sight.

World sugar prices have tended to be firmer this year — they are averaging US9c/lb in New York as opposed to around

Looking Sweeter

New York world sugar price

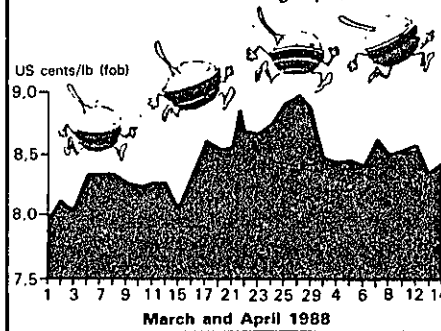

FM 20/5/88

Traders look to sugar as next 'boomer'

10/5/88
B/day

NEW YORK — Copper's record advance last year has traders looking around for another boomer. Some are beginning to focus on sugar as a likely candidate.

International Trading research associate director Walter Greenspan said there was a possibility that world prices for raw sugar would more than triple to 30c a pound or higher in 1988 and early 1989.

He said: "Today's market appears remarkably similar to the historic bull markets (in sugar) of 1974 and 1980 when prices rose to exceed 45c a pound and 65c respectively. Short supplies could result in a dramatic increase in prices in the world market."

Some other people wonder how high the price can go, however; they note that raw sugar prices already have advanced significantly in recent years.

Greenspan said the world was using more sugar and only twice in the

past 20 years had sugar usage fallen from one year to the next.

He said: "Not since 1981-82 has (annual) sugar usage dropped below 104% of the average of the previous three years. If this holds true again, we can project (annual) consumption for 1988-89 at 107.7-million tons."

The industry tries to keep sugar inventories high enough to cover at least 30% of a year's consumption — "below 30%, the supply-demand balance tips heavily toward the bulls as it did in 1974 and 1980".

Greenspan estimated that world sugar inventories stood at 31.8% of the rate of usage, the lowest level in four years.

He said: "More reductions could result in an inadequate flow of sugar from field to refiner to shipper to user, creating a supply gap and a price squeeze. We believe the potential for such a situation is much higher now than it has been for several years."

Greenspan said the outlook suggested to him an even tighter market and a more bullish one. — AP-DJ.

② sugar
S/Hines
10/4/88

Sugar barons accused of running price ring

THE sugar industry has been accused of operating a price ring and of trying to influence the Board of Trade and Industry to prevent the issue of import permits.

It has also been criticised for exporting sugar at a loss of an estimated R150-million a year.

The allegations were made in the Rand Supreme Court when Worldwide Commodities challenged the Department of Trade and Industry about its action in withdrawing a permit to import 6 000 tons of sugar.

Worldwide suggested there were insufficient sugar stocks in SA to meet demand.

In February, the domestic sugar price was increased by an average of 12%, lifting it by R100 a ton to R983.

By Don Robertson

In papers before the Rand Supreme Court on March 26, Worldwide Commodities said the sugar industry operated an "economically unsound and commercially disastrous controlled activity".

The SA Sugar Association (Sasa) denies the allegations, and says that because of a limited disclosure policy which it adopted since sanctions were introduced, it is unable to give details of its stock position.

Sasa managing director Peter Sale conceded in an interview this week that all stocks held by the association were committed to long-term contracts and there was a shortage of "uncommitted" stock.

Worldwide Commodities won its case against the Department of Trade and Industry with costs.

If a new permit is not issued, Worldwide intends to sue the department for damages on a contract it lost to supply Nestle.

Asked whether Sasa had influenced the Department of Trade and Industry, Mr Sale said: "When asked, we gave our opinion to the department that we would not agree to the imports."

Too late

On September 4, Worldwide was given a permit to import 6 000 tons of sugar which it intended to deliver to Nestle. The permit was issued after an application for the import of 12 000 tons was turned down. The permit was withdrawn by the De-

partment of Trade and Industry on September 11.

Worldwide applied for an urgent interdict to prevent the department from withdrawing the permit. A hearing set down for November 17 was postponed at the request of the department and was heard on March 26. But the permit had expired on December 31.

The case arose after an investigation of the industry by Worldwide Commodities which asked Huletts for 80 000 tons of sugar for export to an African country. Huletts said it would be able to supply the sugar only in November this year.

German beet

An associate of Worldwide, Abdool Mangareh, managing director of AQ Holdings, said in an interview he had asked Sasa for 200 tons of sugar for a customer in the Comores. He was unable to obtain it.

He now intends to import the sugar — if he can get a permit.

Worldwide managing director Allan Bowles told me that he was aware of a shortage of sugar in SA, so he investigated the potential for imports.

The investigations showed he could land beet sugar from Germany in Durban at \$220 a ton. His delivery price to Nestle would have been R760 a ton, including the 10% import duty, freight costs and the import surcharge.

At the time, the domestic price of sugar was R873 a ton.

The difference in price would have saved Nestle about R1-million.

Mr Bowles says that after receiv-

ing the import permit, he signed a deal to supply Nestle with 6 000 tons of sugar. He was given a letter of credit for R4,6-million. Mr Bowles arranged for 47 containers a month to deliver 1 000 tons for six months.

However, the permit was withdrawn on September 11. No reasons were given — the Board of Trade and Industry insisting that in terms of Article 2 (4) and 2 (1) of the Import and Export Control Act of 1943 it need not do so.

Mr Sale says it may be assumed that export sugar is sold for about R300 a ton, but he denies that domestic sales subsidise exports.

"We take into account total fixed costs and allocate these over the entire crop," he says.

He says that if sugar is used for export, the SA manufacturer can claim a rebate of R520 a ton, reducing the price to R463.

"We pay out millions a year on this basis," says Mr Sale.

Monopoly charge

Mr Bowles said in papers before the court: "I find it strange that the department (trade and industry) supports a monopoly in the sugar trade where they supply overseas manufacturers with sugar at a price one-third of what our local manufacturers have to pay and then permit those overseas manufacturers to export their products to South Africa and compete against our local products."

He said that if SA manufacturers were supplied with sugar at a third of the present price, their turnover would increase, cost would decline and demand would rise. This would result in an increase in employment in the manufacturing sector.

The sugar industry employs 20 000 workers, and the manufacturing side 40 000. Mr Bowles argued against the preferential treatment given to sugar growers and millers.

Mr Bowles said that if the permit were not re-issued, his company could lose R2-million and be forced into liquidation.

On March 26, Worldwide applied for a new permit, but has not received a reply.

Sugar production in SA last season was about 2,1-million tons.

UNEMPLOY

Address:

fm 18/3/88

millers. Only approved expansion on such a major scale on the present 200 000 t sugar output from the area could justify moving the Natal mill to Komatipoort.

In the event, government made a token gesture. Thirty local farmers not producing cane, were granted approval to grow 3 500 t each. But since this will process into only 15 000 t of sugar, hopes that the mill could be immediately relocated were dashed.

However, Natal growers and millers still suspect the new owners are banking on additional quotas to lift approved production levels in the eastern Transvaal to the point where a second mill could be economically justified (to between 75 000 t and 100 000 t of sugar).

They can think of no other reason why Komatipoort Mayor Jan Henn and colleague Jan Lourens bought a mill that is old, small, in a poor state of repair and operating in an over-supplied market.

Bartlett will visit Eshowe on April 11 to hear Natal growers' complaints. While appearing to rule out immediate quota changes, he is leaving the door open for discussion.

"Many people make business decisions based on their perceptions of what might happen in the future. Some make correct decisions and others don't. At this stage, there is no plan to expand the industry. Should it ever happen that the industry started considering expansion, the SA Sugar Association would have to be approached and their point of view considered.

"Having said that, there is a lot of potential for sugar production in the eastern Transvaal. This was identified by the Rörich Commission. So some day in the future there will be expansion there. But whether it will happen now or next year, each individual must assess for himself," Bartlett said.

That's an issue Entumeni's new owners have obviously taken a view on. ■

SUGAR QUOTAS

3) Sugar

The millers' tale

Eastern Transvaal sugar millers have been trying to sweet-talk government into increasing the region's production quotas.

Prior to buying Eshowe's Entumeni sugar mill (*Business* March 4), its prospective eastern Transvaal owners visited deputy Economic Affairs and Technology Minister George Bartlett in January.

The reason for the visit, Bartlett confirmed this week, was to plead for an extra 50 000 t sucrose quota for eastern Transvaal

4/3/86
③ Sugar
FM

SUGAR MILLING

Quite a quota stir

In Natal, it could become known as the Nkomati discord: the day upstart farmers from Komatipoort in the eastern Transvaal stole the march on SA's sugar barons.

The source of their embarrassment was the raid by Komatipoort mayor Jan Henn and colleague Jan Lourens on the Entumeni sugar mill, near Eshowe.

The move has left them the owners of the mill — which they snatched from under the noses of several prominent Natal bidders.

Now Natal sugar men are asking: do their rivals in the eastern Transvaal know something they don't and is government about to favour them by granting additional production quotas?

The question is why eastern Transvaal interests made an offer in the first place?

The mill is in a poor state of repair, old, small; and at a time of government-frozen production quotas, vulnerable to low returns in a market supported internationally, and which looks set to remain oversupplied for some time.

"It makes no sense whatsoever," reflects J B Bullock, manager of the Lonrho-owned Glendale Mill. At an annual output of around 35 000 t of sugar, Glendale and Entumeni are exceptions to the rule in Natal's

sugar industry: they are small (Entumeni produced around 30 000 t); independent of the major groups, Tongaat Sugar and C G Smith Sugar (Entumeni was owned by the Premier Group); and are supplied by many small, independent growers.

"At that scale, operations tend to be marginal. It is highly unlikely that new entrepreneurs could operate economically. Even with some kind of preferential treatment, they would come up with no more than 60% of the cost of production," says Bullock.

The rest of Natal's sugar industry is equally mystified. SA Cane Growers GM Rex Hudson and SA Sugar Association counterpart Peter Sale are both puzzled.

Henn and Lourens, meanwhile, have done nothing to explain their purchase. So the industry is left to speculate. The scenario currently enjoying the widest currency is that the two men know something about production quotas the rest of the industry doesn't.

Sugar production is officially kept under wraps to deny sanctioners insights into export efforts. It is estimated at around 2 Mt annually, half of which is sold domestically and the rest on depressed world markets. Most of the sugar is grown in Natal, but from humble beginnings the eastern Transvaal has grown to a point where it produces 10% of the annual crop.

Grown under irrigation, the eastern Transvaal harvest is high-yielding and cost-effective. Expansion potential is high and conditions are secretly envied by Natal's largely dryland farmers, who are often at the mercy of the climate.

The problem is that production quotas are fixed by government and, given the depressed nature of the world market, the industry is supposed to be in a phase of enforced shrinkage.

Under the circumstances, the only way to grow more cane is to buy out existing quotas. One way of doing this is to buy a mill. But to close or move a mill means the marginal economies of getting cane processed virtually puts paid to growers' hopes of shipping their cane further afield.

Hence the outrage in Natal at news of the deal and speculation that the new owners propose moving the mill to the eastern Transvaal. KwaZulu's Mangosuthu Buthelezi has asked government to help the 1 300 black growers who could be affected.

Of course they could sell their quota rights, and Henn and Lourens might buy them. But even were all the quotas bought up and transferred to the eastern Transvaal, costs of relocating the mill would render the exercise uneconomic.

This is why Natal sugar men cling to the belief that increased production quotas for eastern Transvaal farmers are in the offing. The justification: the need to keep farmers on the Transvaal/Mozambique border.

The man who might answer this question, George Bartlett, Deputy Minister of Economic Affairs and Technology, could not be contacted by the FM.

③ Sugar
FM
4/3/86

(3509710)

B/day 30/3/88

Importer alleges sugar-trade monopoly

ALLEGATIONS of monopolistic practices in the sugar industry were made in an urgent application brought against the Director of Import and Export and the Economic Affairs and Technology Department in the Pretoria Supreme Court last week.

The action concerned the cancellation of a permit issued to import-export company Worldwide Commodities for the importing of 6 000 tons of refined sugar.

The permit itself had expired by the time of the court judgment and could not be reinstated, but Mr Justice R Gold-

LINDA ENSOR

stone awarded costs to the company. Worldwide Commodities MD Alan Bowles says the firm is proceeding with a claim for damages against the department.

Bowles alleged in an affidavit that pressure by members of the sugar industry on import-export officials was the reason the permit had been cancelled a week after it had been granted.

But Import and Export director Pieter Barnard said the issuing of the

permit had been a mistake by his assistant director who was not fully conversant with the regulations governing the importing of sugar, and who had reached his decision on the basis of misrepresentations.

Bowles believed "that the permit was withdrawn by the deponent (Barnard) because of the pressure brought to bear on him from the sugar industry and for no other reason".

In his reply, Barnard said no permits

● To Page 2 →

Importer alleges sugar-industry monopoly

were issued for the import of large quantities of sugar because SA had to export its surplus sugar (between 0,8-million and 1,1-million tons annually) at very low prices and sometimes had to import sugar for resale in order to meet fixed export contracts.

Permits for importing sugar were issued by the SA Sugar Association which would suffer a loss of about R3,4m if Worldwide's permit was allowed. This

(3509710)



● From Page 1 30/3/88

was the difference between the local price of refined sugar (R873 per metric ton) and the export price (R300).

Bowles responded: "The reasons advanced (apparently) in support of the monopolistic practice in the sugar industry, when analysed, reveal an economically unsound and commercially disastrous controlled activity."

350000
B/dow
23/3/88

Sasa data to remain secret

MICK COLLINS

THE South African Sugar Association (Sasa) has decided to maintain its embargo on the release of a wide range of statistical information relating to cane and sugar production.

Sasa says the uncertain political climate in which exporters are forced to operate in overseas markets and the success of the strategies adopted by the sugar industry, externally and internally, to protect its export markets, resulted in the decision.

The March edition of the Sugar Journal says: "The world market price has on average been marginally higher than in the previous season, but the return per ton on exports is expected to be lower in 1987/88 due to the stronger rand in relation to the US dollar.

"In spite of the steady rise in world consumption over the past few years, import demand has been falling. Between 1983 and 1987 it is estimated that it declined by more than 2,5-million tons. This has been mainly due to reduced consumption by the large industrialised countries."

Although the outlook continues to improve, the pace of recovery has not been as quick as was anticipated a year ago, due mainly to world sugar production exceeding expectations.

Sasa says that, with the limitations on growth of world markets, the production of ethanol from sugar cane would generate more revenue over the long term than would otherwise come from world markets.

It says foreign exchange savings on petroleum products would amount to R63m, if the ethanol scheme were introduced.

Also, in view of the over-supply of sugar on world markets, the permanent withdrawal of SA's export sugar would be a contribution to reducing the over-supply internationally.

Transvaal

SUGAR INDUSTRY FMS/2/88

A brighter outlook

The recent surge in world sugar prices to their highest levels since 1983 — prices shot up by 61% to US10c/lb on the open market over the past five months — could help local industry to reduce its R327m debt burden.

This could add some R150m to the season's export revenues, should prices remain at current high levels. But with the London market showing signs of consolidation, some traders expect the price to come off its highs.

Meanwhile, threats of sanctions, specialised trading (Cuba's preferential sales to Russia and US preferential quotas at double world prices are cases in point) and unpredictable seasonal factors also combine to keep a grey cloud within the silver lining.

Be that as it may, a substantial portion of any export gains — theoretically projected at present price levels at around US\$72m — will probably be used to reduce the industry's debt.

Consequently, the prospects of a major boost to Natal's regional economy will remain largely unfulfilled.

In 1986, SA produced 2,1 Mt of sugar. Domestic consumption was 1,2 Mt, leaving some 900 000 t for export. Gross export revenues in that year amounted to R205,8m, compared with domestic revenue of R813,5m.

Behind the recent free market price rise, explains South African Sugar Association export manager David Hardy, is an international rule of thumb that world stocks should equal 25% of annual consumption to insure against production shortfalls. By this logic, depressed prices of the past four years have accurately reflected a stock:consumption ratio which has been declining slowly from a peak of 41% to 32,8% last season.

"So, in the process, one would expect

prices to firm. But in the short term, export prices have now been boosted more strongly than would normally be the case by various structural shortages of supply," says Hardy.

These arise from production shortages in Thailand and the Philippines, and drought in Brazil and Cuba. The net upshot is that world stock levels are projected to drop to 32 Mt in 1988/1989. And London sugar traders expect global stocks to fall by some 4 Mt to meet Russian and Chinese demands.

"In particular, there is speculation that Cuba's agreed level of supplies to countries like Russia and China will not be available, and they will be forced onto the open market. Prices are reflecting this expectation."

Hardy believes that prices will remain at current levels "for a large part of 1988," but that the trend later in the year will depend on world weather conditions.

Since the sanctions campaign against SA, the shutters have gone up on our production and trade statistics. But the last set of international figures — which included SA's contribution to world trade — showed that the 865 000 t exported represented about 3% of total world trade and 5% of free market trade.

At an average price of US6,04c/lb, the export income to the industry in 1986 amounted to around \$112m. Assuming export volumes have remained constant and that the price remains at around US10c/lb for the year, gross export income could be up to about \$185m on 1986 figures.

Prospects sweeter for sugar exports

3506ML

Bl/day MICK COLLINS 28/1/88

SA SUGAR exports are set to recoup major losses as a tight situation in world supplies has sent prices soaring on international markets.

The local industry, which lost its US market following the American sanctions package, is poised to start earning return on capital with the firmer world prices resulting in improved export earnings.

Analysts yesterday predicted a boom if the trend continued and said spot prices quoted in London were over the US10c a pound mark — in sharp contrast to the US6,2c a pound level maintained for the 1986/87 season.

Asked if world-market levels would push local prices higher, SA Sugar Association (Sasa) GM Peter Sale said: "Definitely not. It will have no impact whatsoever."

"The two markets are separated economically. Local markets are not affected by fluctuations in the world prices. However, I cannot preclude a rail cost increase which would be beyond our control."

He said the Sasa price structure was set by government and "thereafter, the customer pays railage".

Industry predictions that the US10c-a-pound level would be sustained throughout 1987/88 were not overly optimistic;

● To Page 2 →

Prospects sweeter for sugar

3506ML

← ● From Page 1

world price levels were obviously good for SA exports.

In London yesterday, raw prices came off slightly with February/March contracts set at US\$260,40 a ton (down \$2,80).

In its Sugar Journal, Sasa reported the Australian Bureau of Agricultural and Resources Economics as saying world production was expected to decline by about three-million tons in the coming season, with a concomitant rise in prices.

The bureau said: "A stock level of around 32-million tons would indicate tight world supplies during 1988/89 and very likely herald the start of another short-term boom in world sugar prices, as occurred in 1980/81."

Meanwhile, SA consumers have only four days left in which to stock up on sugar supplies before the introduction of new prices announced last month by Sasa.

Sale said the 11,5% increase due on

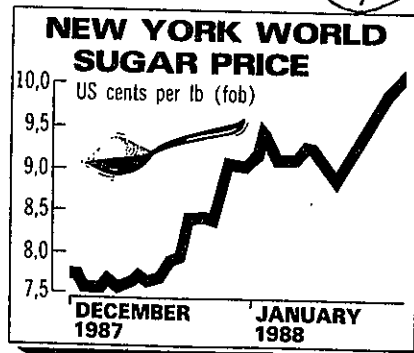

Graphic FIONA KRISCH Source SASA

February 1 was well below the inflation rate and 3,5% less than last year's price hike. "This rise is essential for the economic survival of the industry."

Industrially, the price of white sugar will rise by 12,6% from R873 a ton to R983, while brown sugar will go from R797 a ton to R892 — an increase of 11,9%.

AP: Times 12/1/88

3 Sugar

Sugar industry begins probe into weed-killer

Staff Reporter

RESEARCH into the effects of a deadly weed-killer — one of two ingredients in "Agent Orange", used in Vietnam to destroy tracts of jungle — has been launched by the sugar industry and the executive of the National Fresh Produce Committee.

The investigation follows reports that the hormone herbicide 2,4 D is being widely used in South Africa, particularly in Natal's sugar plantations.

Symptoms which appeared in American soldiers exposed to "Agent Orange", such as skin cancer and deformed offspring, are now occurring in Natal.

The South African Sugar Association (SASA) said yesterday that in the light of "conflicting claims and contradictory evidence" regarding the effects of hormone herbicides, research had been initiated to provide "a conclusive answer".

Since the sugar industry used less than 25% of all herbicides in South Africa, an attempt will be made to involve all other agricultural sectors.

"The objective is to arrive at firm conclusions on the involvement of hormone herbicides before the start of the 1988 summer spraying season," a SASA spokesman said yesterday.

The bitter sweet rise in prices

By SINNAH KUNENE

(3) Sugar

IT is a bitter pill to swallow for those with a sweet tooth from the beginning of next month - the price of sugar is going up.

The news that all sweet goodies go up by 12 percent on February 1, has hit the poor and left them stunned.

President of the Black Consumer Union Ellen Khuzwayo sounded distraught when approached for comment.

"What do you do with people who have already been hit by unemployment and those who earn poor wages and can't keep up with the high cost of living?"

"Sugar is a primary product used by poor families and they can't live without it," said "Ma-K," as she is affectionately known.

"I personally feel helpless and heaven only knows how these people feel," she lamented.

The hardest hit will be people from the rural areas who depend on canned foods, because they have no fridges. Their children also live on soft porridge, which if served without sugar, is inedible.

The South African Sugar Association announced this week that the price of white sugar (industrially) will rise by 12,6 percent from R873 to R983 a ton, an increase of R110 per ton. Brown sugar will increase from R797 to R892 a ton.

This means a 2,5kg pack will cost 38c more.

Sasa, however, believes the increase is well below the current inflation rate of 16 percent and managing director Peter Sale assured consumers there would be no further increase in the price of sugar this year. He urged consumers to take advantage of the pre-announcement, which gives them four weeks in which to buy sugar at the old price.

However, the news of the increase is being regarded as a tip of the iceberg as both manufactures of foods that contain sugar and consumers expect more price increases early in the year.

Dave Upshon, of Nestle's corporate relations department, said condensed milk and confectionery lines would definitely be affected by the increased sugar price, although there would be an overall increase on all their products when other increases were announced.

Jo-Anne Papas, manager of Mono Bakery, also shared the same sentiments. She said consumers should expect a

price increase on confectionaries because "an increase on the price of raw materials is unavoidable".

The managing director of sweet manufacturers Chapelat Industries said although they had not yet received an official notice from Sasa, their product would definitely be adversely affected by the increase.

"There is a very steep increase in raw materials and we're expecting many more increases to be announced. Although we cannot at this stage determine the percentage, the increase on our products may be between 10 and 12 percent," he warned.

Other foodstuffs likely to be affected by the increase are soft drinks, canned foodstuffs and ice cream.



"M-K" Kuzwayo ... a bitter pill.

'Good Samaritans' rob youngster

By SIMPIWE NCWANA

A YOUNG man from the Ciskei, who came to Johannesburg look for his long-lost brother, was on Sunday afternoon robbed of his money and a suitcase full of clothes near the Charles Hurwitz Santa Hospital, Baragwanath, and ended up spending the night at the Moroka Police Station.

Mphathi Mzayiye, 21, was robbed by three men who had offered him a lift from Alice. The men had promised to help him find his elder brother, Buyisile Mzayiye.

Mzayiye said that when they were near the Santa Hospital, the men stopped the car and took out knives, threatening to stab him.

"They demanded all the money I had. I gave them R100, but they searched me and took another R80 which was in my inner pocket. They then kicked me out of their car and drove off with my suitcase.

"I was shown to the Orlando Police Station, where I laid a charge of robbery and assault and gave the police the registration number of the car.

"I moved on not knowing where I was going, until I landed at a house to ask for water and came across men who asked me a lot of questions.

"They turned out to be police, who then took me to the Moroka Police Station and told the other policemen that I was a terrorist and they then put me in a cell. Early the following morning they took me to the Protea Police Station and I was released after a long process of questioning," he said.

Police liaison officer in Pretoria, Captain RA Crewe, confirmed the incident and said that Mzayiye was arrested under the Criminal Procedure Act as a suspect. He was released after observation and questioning.



Mphathi Mzayiye

Sugar price to increase

THE price of sugar will be increased by an average of 11,5 percent from February 1, the Sugar Association announced yesterday.

The increase will be "well below" the current rate of inflation in South Africa of 16 percent, the association said.

"The price of white sugar will rise by 12,6 percent from R873 to R983 a ton, an increase of R110 a ton. Brown sugar will increase by R95 a ton, from R797 to R892 a ton. This is an 11,9 percent increase," the association said in a

By MZIKAYISE
EDOM

statement.

Mrs Sally Motlana, president of the Housewives League, said she was sad and shocked that the price of sugar was going up.

"I do not know how the black people will survive with so many increases this year. Everything is going up everyday but our salaries remain low. How do they expect us to cope?" she asked.

To Page 2

350972

6/1/88
Smethun

Out of work

From Page 1

The East Rand People's Organisation condemned the new increase. The organisation said thousands of people were out of work and it was unfair to increase the sugar price when they could not cope with the present price of sugar and with that of other foods.

The South African Women's Bureau said: "We are totally against the increase. Is it necessary for the Sugar Association to increase the price of sugar? The consumer will suffer the most as a result of the increase."

Stores pledge to hold off sugar price rise

By Inga Molzen

Two major supermarket chains have pledged to delay sugar price increases for as long as possible.

They were reacting to an announcement by the South African Sugar Association yesterday that from February 1 the average sugar price would be increased by 11,5 percent.

The price of a 2,5 kg pack of white sugar will rise by between 30c and 35c (11,5 percent).

A 1 kg pack of brown sugar will be increased by an average of 11c or 10,5 percent.

Pick and Pay's senior buyer, Mr Richard Cohen, said while any price increases were to be regretted because they were inflationary, "the prospect for the consumer doesn't look good because no one was really doing anything to combat the inflation rate".

A spokesman for Checkers said: "We have negotiated with our suppliers and we will hold off the price increase for as long as possible."

A director of OK Bazaars, Mr Allan Fabig, said the company would try to keep prices down for as long as stocks lasted.

The ripple effect on the economy would be enormous, he said, because sugar was a main ingredient in most canned foodstuffs, jams and confectionery.

The director of the Consumer Council, Mr Jan Cronje, warned manufacturers "not to misuse the opportunity by putting up their prices unnecessarily. The council's monthly price surveys of 55 stores across the Witwatersrand will show up this tendency."

The Sugar Association said the advance announcement would allow the public to stock up.

3509R

5702 6/1/88

SUGAR

ALTS & SEEDS

1989

SUGAR INDUSTRY

350 GAR
 Email
 22/12/89

Sweet deal turning sour

As plans for the sugar industry's ethanol-from-cane plant become shaky, so do the deregulation proposals put forward by the South African Sugar Association as a bargaining chip in negotiations for the plant.

The deregulation package would allow more small, mainly black, cane growers into the industry; release additional land for cane; and, among other things, provide for a new production area and mill in the eastern Transvaal.

The association, however, has made it clear that deregulation can go ahead only if government grants permission to build a R130m ethanol plant at Richards Bay. But government's pre-election promise to build the plant has been evaporating as it takes a hard look at costly synfuel projects.

The association argues that the extra 150 000 t of sugar and the same amount of molasses needed at the plant justifies expanding the industry. But without the plant, it says, expansion is not a good idea because the domestic and foreign markets are not certain to absorb the additional sugar.

Does the deregulation package, which would loosen the association's tight control over the industry, really depend on the ethanol plant? Isn't it possible to deregulate meanwhile?

Yes, say farmers in the eastern Transvaal, who argue that the industry *must* expand, with or without the plant. Even the association's figures, and statements by the former Deputy Minister of Economic Affairs & Technology George Bartlett, show that there might well be room for additional growers.

When Bartlett, a long-time sugar grower, announced the deregulation package in April, he emphasised that it depended on growth in the local market and the possibility of finding new outlets "at realistic prices." He also said, however, that trends in the local market showed that demand would increase by 150 000 t "within the next four to five years."

That was in addition to the 150 000 t for the ethanol plant, he says.

So one thing is certain: there is room for at least an additional 150 000 t of sugar production — whether by small cane growers in KwaZulu, or the expected new production area in the eastern Transvaal.

Some 23 000 small cane growers, mainly in KwaZulu, provide nearly 170 000 t of sugar a year, about 8% of the industry's total of 2,2 Mt. Opening up the market would allow in roughly 10 000 new growers who would probably not produce more than an extra 140 000 t of sugar.

In addition, if the proposed mill is built at

Komatipoort, the national pool would grow by about another 150 000 t of sugar a year. Couldn't this increased production of about 12% be exported?

Internationally, sugar prices are about the highest they have been this decade. Association chairman Glyn Taylor describes the market as bullish. The world stockpile has shrunk and world producers cannot meet the demand for an extra 2 Mt a year. Taylor also confirms that SA is managing to export sugar despite sanctions and the loss of the North American market.

But the association argues that to go ahead with more cane production without the ethanol plant would make the industry too dependent on exports.

The association's international marketing director, David Hardy, says it's more than overcaution that warns against relying too heavily on exports — even if this would create more jobs. He says the usual trend is a rise in prices followed by a sharp drop. "To expand in the euphoria of higher prices and good economic conditions isn't necessarily the most logical thing to do. You have to look down the line and realise that bad times are almost certainly around the corner."

One sugar farmer in the Komatipoort district disagrees. Jan Lourens, former director of the SA Millers Association and now a member of the SA Cane Growers Association, says the industry must expand now, and argues that the additional sugar can be exported.

"I believe that, whether the Richards Bay plant comes on stream or not, the industry can increase exports. The political outlook has never been brighter than it is now, with a real possibility of some sanctions being eased. We could miss the chance of taking advantage of better world prices and selling more sugar overseas if we don't start expanding now."

Both Hardy and the association's new executive director, Mike Mathews, caution that speculators now have a strong influence on prices, making trends harder to read. "We just cannot risk becoming too dependent on the world market. World producers can, and they do, react fast, and when this happens the price can drop quickly," Mathews says.

As for the domestic market, Mathews says it's flat. Therefore, deregulation of the industry and the expansion it would entail cannot be unscrambled from the ethanol plant.

Eastern Transvaal growers argue that the domestic market is growing between 3% and 5% a year and could cope with the expansion required for a new mill at Komatipoort.

Lourens believes that government event-

ually will approve the ethanol plant — and, meanwhile, the deregulation package should be implemented. He believes there is space for more production in the local market; that new jobs would be created in the eastern Transvaal — and that the border region would thereby get a "stabilising influence."

"As far as farmers here are concerned, the industry must expand," he says. "It has

Sweeter by the ton

World sugar consumption

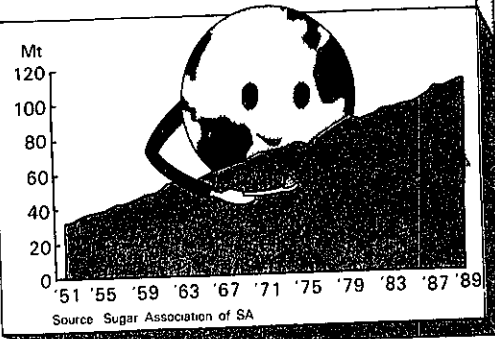

expanded in the past, and must keep on growing now, independent of a decision on the ethanol plant." So: "All the indications for green — go for expansion." ■

Sugar giant posts modest figures

B/Pace 1/16/11/89 sugar

SYLVIA DU PLESSIS

TONGAAT-HULETT has posted a modest set of interim figures following a 32% hike in its interest bill to R44,6m (R33,9m) and a marked drop in contributions from its building materials division.

Helped only by strong performances from its sugar and aluminium divisions, the diversified Natal-based group lifted earnings 16% to 115,7c (99,5c) a share in the six months to September — far off last year's 43% growth.

This was realised on turnover, which rose 15% — in line with inflation — to R1,86bn (R1,6bn), and operating profit, a sound 20% up at R191,6m (R160m), thereby widening margins from 9,9% to 10,3%.

Attributable earnings grew 19% to R86,6m, from which a halfway dividend of 26c a share, 13% up from the corresponding 23c, has been declared.

Directors said yesterday the building materials division had been hard hit by difficult trading conditions, with demand for clay and concrete walking products declining sharply as a result of high interest rates impacting adversely on home-building activities.

A number of Corobrik factories had been closed, and other remedial action had been taken to reduce production output and overhead costs, they said.

But both the sugar and aluminium divi-

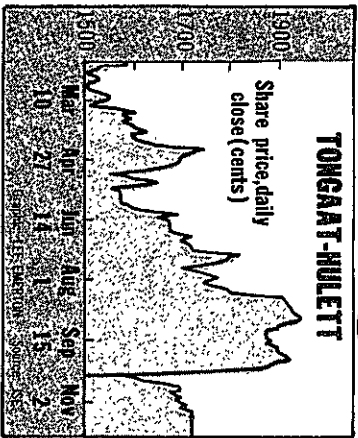

sions had turned in "sparkling" performances, with the latter again producing strong improvement in volumes.

The contribution of these divisions to profits would reflect significant increases on last year, with good spring rains, a higher world sugar price and an increased share of total industrial sugar production bolstering sugar's offering.

The group's remaining divisions — foods, textiles, starch and sweeteners — had performed satisfactorily, given the highly competitive trading environments within which they operated, they added.

Turning to the increase in interest payments, directors said this was brought

□ To Page 2

Sugar giant will *B/Pace 1/11/89*
 about by higher interest rates and sleeper borrowings of R580m (R482m).
 However, taking into account the seasonal nature of agricultural operations, borrowings were expected to reduce to about R330m by year-end.

3 sugar □ **From Page 1**
 While the second half would be characterised by more difficult trading conditions — the result of tight monetary constraints — the directors anticipated full-year earnings of 235c (214,3c) a share, assuming no further significant deterioration in the economy.

Ethanol project could be big 'job provider'

119189

Own Correspondent

3 Sugar

DURBAN -- Natal's new ethanol blend of petrol could be available at the pumps in January 1992 if plans went according to schedule, Mr John Chance, vice-chairman of the SA Sugar Association, said in Durban yesterday.

Welcoming the Government's approval in principle for the ethanol project, Mr Chance said it would give a major boost to the deregulation process, help the industry to expand and directly create more than 14 000 jobs.

It would "broaden and strengthen the economic base of the industry which is the mainstay of the economies of Natal, kwaZulu and the eastern Transvaal".

The announcement also spelt a go-ahead for the proposed sugar mill and other industrial expansion in the eastern Transvaal.

The R120 million distillery would be built near Richards Bay at a site to be determined and would be owned by the Sugar Association itself, Mr Chance said.

However, the actual operation might be contracted out. Financial details still had to be worked out.

Mr Chance said that while approval had been given in principle, a number of practical decisions had to be taken in consultation with many bodies, including the oil companies, the Department of Water Affairs and the Department of Mineral and Energy Affairs.

Ethanol nod to sugar industry a sweetener?

ARCUS 1/9/89

3 Sugar

The Argus Correspondent

DURBAN. — The government go-ahead in principle to the sugar industry to produce ethanol as a fuel additive has been generally welcomed but a question mark has been raised over its political timing.

The Deputy Minister of Economic Affairs and Technology, Mr George Bartlett, however, denied the announcement was timed to coincide with the election six days away.

"I would have made the announcement in May if I could," he said.

He made the announcement yesterday on the Natal North Coast where the National Party has its back to the wall in both the Umhlanga and Umfolozi constituencies.

The Democratic Party Umhlanga candidate, Mr Kobus Jordaan, welcomed the go-ahead

but said he found the timing typical of National Party attempts to buy voters.

Mr Jordaan, who predicted earlier this month that the government would announce the project before election day, said it should not only make long overdue announcements like the ethanol plant.

"It must also spell out what it intends doing about other major issues in Natal.

"We challenge them to spell out their final consolidation proposals for Kwazulu.

Single unit

"The Democratic Party sees Natal and Kwazulu as a single unit which must be reflected in second-tier government."

Mr Jordaan said the sugar industry had also been saddled with a R327-million debt which it had to solve itself.

Against this, maize farmers had been bailed out of a R400-

million debt by the government.

The National Party Umhlanga candidate, Mr Renier Schoeman MP, who attended the NP meeting where the announcement was made, said: "I am delighted the government has taken a positive decision. It will have a dramatic effect on the economic well-being on large parts of Natal.

"I am also glad that the government has taken a final decision because the uncertainty could have had a negative effect on the whole project."

He paid tribute to the supportive roles played by Mr Bartlett and Mr Stoffel Botha as the Natal Cabinet Minister.

He said any allegation "that this is an election sweetener is petty and small-minded."

(Report by B Cameron, 85 Field Street, Durban)

● See page 13.

MCLW 1/9/89 3 Sugar (1) (2) (3)

Petrol from sugar by 1992 ?

The Argus Correspondent

DURBAN. — Natal's new ethanol blend of petrol could be available at the pumps in January 1992, Mr John Chance, vice chairman of the South African Sugar Association, said in Durban yesterday.

Welcoming the Government's approval in principle for the new ethanol project, Mr Chance said it would give a major boost to the deregulation process, help the industry to expand and directly create more than 14 000 jobs.

It would "broaden and strengthen" the economic base of the mainstay of the economies of Natal, KwaZulu and the Eastern Transvaal. The announcement also gave a go-ahead for the proposed new sugar mill and other industrial expansion in the Eastern Transvaal.

The R120-million distillery would be built near Richards Bay

at a site still to be determined and be owned by the Sugar Association itself. However the actual operation might be contracted out. Details of the financing of the project still had to be worked out.

Mr Chance said while approval had been given in principle several practical decisions had to be taken in consultation with many bodies, including the oil companies, the Department of Water Affairs and the Department of Mineral and Energy Affairs.

Product diversification to reduce dependence on the volatile export market could benefit the sugar industry. Fuel alcohol had been singled out as the only product with a market volume that could sustain substantial diversification. The ethanol project would provide an on-going renewable source of energy that could be maintained indefinitely.

He said the industry had for

over a decade studied the use of ethanol in several countries and conducted field tests on local vehicles.

These tests had indicated the use of ethanol would be beneficial to the environment, reducing pollutants like lead, hydrocarbons, smoke and carbon monoxide.

Ethanol was a recognised octane enhancer.

He said final technical aspects were still to be decided, but it was not likely engines would need adjustment to take the new ethanol blend, which probably would be sold mainly in Natal. Sasol's blends already were in use in the Transvaal, while Moss-gas products might prevail in the Cape.

"We do not see any technical difficulties, as in the US all automobile manufacturers have extended their warranties to cover ethanol blends. Our plant will produce an extremely high grade of ethanol," he said.

Ethanol project will bring benefits to community

Abus 11/19/89
3 Sugar

THE proposed R112-million ethanol from cane sugar plant announced yesterday by the government is small by comparison with the mighty and controversially expensive R7,3-billion Moss gas project.

Apart from the huge amount taxpayers will have to shell out on Moss gas the ethanol project will far wider direct benefits and will also give the important sugar industry in Natal and the eastern Transvaal a more stable future.

Despite the obvious timing of the announcement to glean maximum political capital there is no doubt that the project will bring many benefits particularly for low income group blacks.

There is however likely to still be a debate on its economic viability as the ethanol will be more expensive than the current price of refined petroleum.

Unlike the Moss gas project which will employ a mere 1 200 people when it is on stream the ethanol project will provide an estimated 20 000 people with work at a incredibly lower job per Rand cost.

This Mr George Bartlett, deputy Minister of Economic Affairs and Technology, says is one of the major reasons for the go ahead for the project.

Mr Bartlett, himself a sugar farmer and former chief of the Illovo Sugar company, said in an interview that the whole project had undergone a major investigation over two years before the green light had been given.

Initially the idea for the plant came from the sugar industry which was battling under a collapsed international sugar price.

Farmers were feeding cane to cattle and digging out their fields and planting timber.

Mr Bartlett had just been appointed

By BRUCE CAMERON, Political Staff

deputy Minister and was involved from the start.

The issue was referred to a group of accountants who were already involved in sugar as the government-appointed agents who assessed the then fixed price of sugar.

The accountants were also involved in the setting of fuel costs for the government.

They found the project "looked hopeful."

By then however the government had appointed the National Energy Council and it took over the investigation.

The Council felt the project was too small to warrant serious consideration against synthetic fuel projects like Sasol and Moss gas.

However it did see that there were socio-economic benefits.

Mr Bartlett said at the same time he was working on the deregulation of the sugar industry.

There were a number of objectives in deregulating the industry.

The first was to allow easier access to the industry, especially smaller farmers and mainly small black farmers.

The entry to the industry had been restricted by the quota system that had been introduced to limit the production of sugar cane following price slumps.

There were also considerable problems over the transport of cane to mills in which there were many expensive anomalies. The only way to straighten out the anomalies so that no one lost was to increase production.

The third problem was the under-utilisation of many mills including the huge and modern Felixton mill. The under-utilisation was adversely affecting price structures.

The problem with increasing production to solve the three problems

was the uncertainty and riskiness of the international market.

The risks were caused by sanctions with South Africa having already lost markets in the United States and Canada and wildly fluctuating prices.

Price fluctuations have become far more marked as result of European production from sugar beet with substantial subsidies being paid and surpluses being dumped at a loss on the international market.

The practise has not only affected the efficient South African sugar industry but knocked many third world countries out of the industry altogether.

Mr Bartlett said the answer was clearly ethanol. Ethanol production would increase the production of sugar from its current 2,2-million tons by an additional 300 000 tons.

Then there was the additional benefits of being able to create extensive labour opportunities particularly for blacks.

Unlike the other synthetic fuel projects there was no demand for high technology and skills in providing the jobs and the technology was there.

Mr Bartlett said the Government had no intention of going into cane sugar synfuel in a major way such as Brazil, which was 100 percent on ethanol.

Although the production was small in comparison to the Sasol and Moss gas projects, the ethanol plant would make a contribution towards meeting the government's target of making South Africa 40 percent self-reliant.

Mr Bartlett emphasised the project was fully privatised with the South African Sugar Association, which was a co-operative of growers and millers, constructing the plant at Richards Bay.

"The sugar industry is one of the most self-sufficient and self-regulating industries in the country."

ENERGY

3 Sugar (circled) (circled) (circled) ST Times 6/8/89

Ethanol go-ahead

By Don Robertson

of 10% ethanol to petrol helped to reduce the lead content. Because ethanol

contains oxygen, combustion improves and carbon monoxide emissions are reduced.

A START could soon be made on a R100-million ethanol plant at Richards Bay if the SA Sugar Association (SASA) is given the long-awaited go-ahead this month.

Sugar barons are enthusiastic that the project will be approved.

The first report on the project was submitted to Minister of Economic Affairs and Technology Danie Steyn last September and the Government's decision was expected in the first quarter of this year. It was postponed to June, but John Chance, chairman of SASA, says a decision will be made this month.

The plant is vital to the planned expansion in sugar production caused by recent deregulation of the industry. The expansion is expected to create 13 000 jobs in KwaZulu and KwaZulu Natal where a mill will be built.

Without the ethanol plant, the sugar surplus would have to be sold on the volatile export market.

The plant would also result in an increase in production by small growers and open opportunities for newcomers. An additional R55-million a year could be earned by growers.

The ethanol plant could also produce cattle feed and fertiliser as a by-product.

An independent environmental study will be done when the project is approved. The use of ethanol as a petrol enhancer reduces lead content. In America, the addition

Sugar deregulated, in exchange for fuel plant

350000

wmail 8-14/9/89

By ELAINE COSSER

THE government showed its willingness to give substantial financial support to the deregulation of the sugar industry last week when it gave the go-ahead for a R120-million ethanol plant.

Deputy Minister of Economic Affairs and Technology George Bartlett announced the government had accepted in principle the need for an ethanol plant which it may have to fund.

The ethanol, to be used as a petrol additive, could reduce South Africa's reliance on foreign fuel sources.

But it is also the key to the deregulation package for the sugar industry — one which will yield substantial benefits for established white growers and new black entrants.

The South African Sugar Association (Sasa) — which will ultimately own the plant — had agreed to the deregulation process on condition the ethanol project was established.

According to John Chance, chairman of Sasa, discussions concerning financial arrangements — such as loans from the government — are underway at present.

Moves towards deregulation began last year when the Department of Trade and Industry met with the association. Final proposals were submit-

ted by Sasa in January and subsequently accepted by the government.

But for the government, protecting established industry interests will be what makes deregulation costly — more so than making way for new black entrants.

The government intends to stimulate the sugar industry by making access to production easier — 13 000 new growers are expected to enter the industry.

But the package of new measures will also enlarge and stabilise the market for sugar through the ethanol plant — and the large, mainly white, sugar producers will derive the benefit.

The ethanol project is expected to guarantee R47-million a year in additional revenue from the sugar mills, all of which are white-owned.

And the large sugar producers, through Sasa, will be collecting the revenue from the new plant.

As part of the package, Sasa will take over sugar pricing control from the state.

A new mill will be built in the Eastern Transvaal at Malelane and 25 tons will be added to the existing quota of sucrose accepted for milling.

But there will be some benefits for small black sugar cane growers too.

At present, there are some 23 000 small growers in the country, most of whom each work two or three hectares of land in kwaZulu. Last year their gross income amounted to R86-million.

Access to the milling of cane is controlled by a quota system. The big, established growers hold most of the quotas, making it difficult for new, particularly small growers to enter the industry.

For the black small growers, benefits of the new package include:

- Open access to mills for any small grower farming within 30km of a mill;

- 13 000 new growers are expected to enter the industry;

- The granting of a higher (local rather than export) price for their cane. This price is on average better than the price awarded to small growers under the present system.

The proposals could boost the industry which is stagnating despite the unusually high international price for sugar.

Sugar-fuel on way, says DP

ster 9/8/89



DURBAN — The Government was planning to give the go-ahead for ethanol production from cane sugar from a National Party election platform, Mr Kobus Jordaan, Democratic Party Umhlanga candidate predicted last night.

If the Government does give the go-ahead for ethanol production as a petrol extender it could give the industry, which is already gaining from the increased international sugar price, a major boost.

Full-scale ethanol production could provide as many as 25 000 jobs in Natal, kwaZulu and kaNgwane, Mr Jordaan said.

Mr Jordaan said at a DP meeting in Stanger that people in the sugar industry were being told an "important announcement" would be made by Deputy Minister of Economic Affairs and Technology, Mr George Bartlett, at an NP meeting at Gingingdhlovu in the heart of the sugar belt on August 15.

Mr Bartlett today declined to confirm or deny the claim.

"We will wait and see if he is correct or not on August 15. He obviously thinks he has some sort of inside information."

Mr Renier Schoeman MP (NP Umhlanga) said he was not aware of what Mr Bartlett would specifically announce at the meeting but "I have asked him to deal with the industry.

"Obviously he will be as up to date as possible. He is the Deputy Minister in charge of the sugar industry and there will be

Own Correspondent

a tremendous interest in whatever he says."

Mr Jordaan said he would welcome the announcement but asked why the Government had not come to the aid of the sugar industry when it had been saddled with a R327 million debt as it had come to the aid of maize farmers who received a R400 million pay-out this year.

Elections

Mr Jordaan said the Government could not only announce sops to the voter from its R1 billion "petty cash" for the elections, such as announcements like an ethanol plant. It should also spell out decisions on issues such as the final consolidation plans for kwaZulu.

● Plans to build a new R500 million oil refinery at Mutare are at an advanced stage, according to Zimbabwe's Energy Minister Mr Kumbirai Kangai.

He said the refinery would have a bias towards diesel because of the high demand by industry and heavy transport.

Mr Kangai said Zimbabwe may import power from Cahora Bassa if peace is restored in Mozambique.

(Report by B Cameron, 85 Field Street, Durban.)

18/8/89

"The market could go up if India, the USSR or China buys," says Man's latest *Sugar Situation* report. "On the other hand it could retreat if none of the above buys."

But the report says downside potential is limited by the overall tightness of supplies "and a conservative European Community export potential."

Attention has focused on India for some months as a potential buyer of bulk whites, "because its production appears to be tailing off to between 8,6 Mt-8,7 Mt, with consumption moving towards 9,7 Mt-10 Mt."

So far, however, there has been little sign of Indian import demand, "other than rumour and speculation." Man suggests that at current market levels the authorities there "would rather destock than import sugar."

In contrast, continued Soviet offtake has contributed to "additional demands on stocks which have worsened the underlying tightness."

Man suggests that world production in 1989-1990 will rise by about 2,5 Mt, but that rising consumption will result in another season of deficit and, therefore, "further stocks drawdowns." It warns, however, that this is a tenuous assessment — its first for-

Topping out?

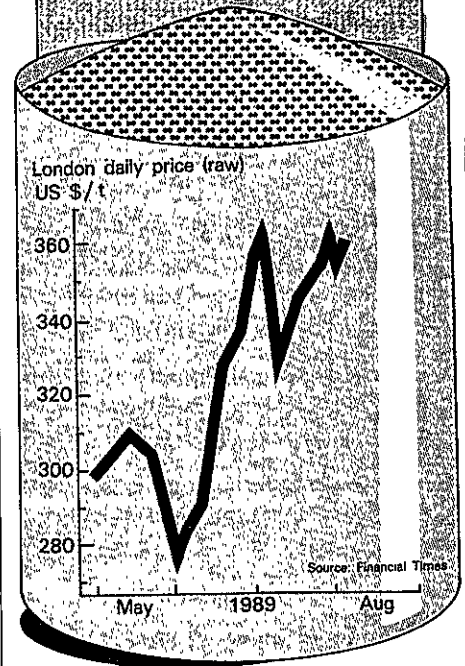

mal projections for 1989-1990, together with revised estimates for 1988-1989, will be published next month.

SUGAR (3 SUGAR) *Prasad*

Sweet or sour?

A small group of large potential buyers holds the key to prospects for the world sugar market over the next few months, according to E D & F Man, the London trade house.

Sugar stockpiled before price rise

3 Sugar

S/Times 15/11/89

THE South African Sugar Association (Sasa) expects consumers and food industries to take advantage of the early announcement of a price increase and build up stockpiles.

The price of sugar will be lifted by 11.3% in the next six months, adding fuel to inflation.

The price will rise by 7% on February 1 and by 4% on August 1, but will probably be held at this level until August 1990. Sasa says the increases will be below the expected inflation rate for the next 18 months of 20%.

Sasa made the announce-

By Don Robertson

ment ahead of the dates of the increases, which it hopes will allow consumers a chance to stockpile.

Storage

Before the price was raised by 12.5% in January last year, an additional 80 000 tons of sugar were sold.

However, because the latest increase will be lower than at the beginning of last year, sales are expected to rise by about 40 000 tons this month.

Frans Oosthuisen, national markets manager of Sasa, says industrial consumers,

such as the canning industry, will build up stocks by one to two months. Chain stores will probably not be able to carry additional stocks because of a lack of storage space.

Dr Oosthuisen says the increase is necessary because of higher production costs brought about mainly by higher wages. Inflation has added to input costs. He says part of the additional costs will be absorbed by the industry.

In June last year, Sugar Millers Association chairman Glyn Taylor said that an upturn in domestic and international markets was under way and with the current good crop, the market would emerge from the trough of the early 1980s.

"While we may have entered the decade with a whimper, we could leave it with a roar," he said.

Borrowings

Last season, SA sales rose by 5% and the international market improved. Sasa was able to reduce its loans, used as a buffer against fluctuating sugar prices, by R40-million to R287-million. It is expected that by July this year, the loans could be reduced by another 50%.

It is expected that sales in the current season will rise by about 2.5%.

Last season, Sasa earned an additional R40-million through hedging some of its crop on the futures market.

Sasa managing director Peter Sale says the association has continued this policy, again with success.

The sugar industry is still keen to develop an ethanol project, but is waiting for Government approval. Mr Sale expects some positive response before the end of next month.

The international market has shown considerable improvement in recent months. On the New York futures market, the price reached a peak of US12c a pound in December for March delivery, although it has come off.

Tight

Expectations of a large offtake by either China or Russia did not materialise and speculators who have sold out. This took the price back to 10.11c a pound and it is expected that it will loose ground to 10c a pound. This compares with about 9c a pound in October.

However, the supply-demand position remains tight says Lindsay Williams, senior international trader at commodity broker Holcom.

He says stocks are nearing an eight-year low and should one of the larger producers, such as Cuba or Brazil, experience any production problems, the position could worsen.

However, in the short term, the market is expected to remain stable at present levels.

Sweet news for sugar

③ Sugar

BIDAY 19/11/89

Business Day Reporter

THE SA Sugar Association is confident most of its R327m in industrial loans will be repaid by the end of the 1989/1990 season.

Chairman John Chance said if world prices held he was sure most of the money would be paid back.

Chance said the sector was awaiting government's feelings on the proposed plan to produce ethanol for use as a blend with petrol.

If the go-ahead were given it would stabilise production and employment and possibly lead to expansion.

"Production costs will be crucial in determining the ability of sugar to remain competitive in the face of threats to its markets from artificial sweeteners," he said.

Chance added last season's improved export prices had replaced the

disastrously low levels of recent years.

He was also pleased by increasing awareness in the sector of the need for good conservation. Companies and private growers were establishing nurseries for indigenous trees and shrubs to rehabilitate and protect waterways.

This was an indication of one positive development flowing from the flood disaster in 1987.

Sasa's Sugar Journal reported Brazil would reduce this year's sugar availability by more than 10% because the country wanted to turn a bigger part of its cane into alcohol.

Traders said a reduction of about 900 000 tons in 1988/89 raw sugar production would be ordered from the current estimate of 8,8-million tons.

Sugar industry conditionally ready to throw doors open to newcomers

By Dave Canning

DURBAN — In a far-reaching move, the sugar industry yesterday announced it was prepared to throw cane production open to newcomers on condition the Government gave a go-ahead for a new ethanol plant near Richards Bay.

Mr Tony Ardington, chairman of the Small Growers Financial Aid Fund, said the expansion, coupled with that earmarked for the Eastern Transvaal, could lead to additional production of 1.5 million tons of cane.

Addressing the Mansomini Irrigation Community, near Stanger, he said the industry had agreed, subject to the erection at Richards Bay of an ethanol plant which had access to the Natal fuel pool, to expand into new areas.

"The most significant reform proposed is that of free production areas, the implication of which is that any person within 30 kilometres of an existing sugar mill can get a quota. This embraces nearly all prospective producers in KwaZulu."

The industry's announcement apparently came in response to pressure from the Government to lower the quota barriers imposed on would-be growers.

In the past few weeks Government spokesman have privately indicated

that relaxation of the quota controls was the price they expected before agreeing to allow the Richards Bay ethanol plant.

In the past the controls have been justified on the basis of a worldwide sugar glut, which has kept international prices below production costs.

In his speech yesterday, Mr Ardington said perhaps the industry could be blamed for holding up the quota barrier in the past decade.

However it had gone through hard times, including drought, low prices and sanctions.

This was not an industry easily able to pick up new responsibilities.

He said expansion of the industry had been minimal over the past decade and many people in KwaZulu and elsewhere had been frustrated in their desire to secure quotas.

Happily, matters now had improved. The drought had broken and the world price had nearly quadrupled.

The latest developments would make the sugar industry unique among major industries in SA by becoming increasingly dependent on the enterprise of individuals in the least developed areas of the country as it entered new markets with new products from sugar.

Sugar markets should strengthen in the 1990's

Stw. 24/4/87
Sugar

Own Correspondant
DURBAN — Worldfood commodity markets, including sugar, should strengthen in the 1990's provided new policy directions are pursued abroad which will dramatically decrease protection of agricultural producers.

This is the view of Tony Ardington, chairman of the SA Cane Growers' Association, who addressed the annual meeting of the Fertilizer Society at the Drakensberg Sun on Friday.

He said there are signs that the Uruguay round of GATT talks are leading the major "players" to review their domestic agricultural policies with the intent of reducing the extent of the producer support programmes. Recently the EEC Agricultural Commissioner introduced a five percent cut in the sugar intervention price.

Sugar beet growing had become disproportionately profitable compared with cereals in the common market and the high domestic price has funded the dumping of sugar on world markets.

The latest moves are good news for an efficient producer like SA "and I expect the economic position of the sugar industry to improve further."

"Today world prices are over four times the level they were in 1985. The drought cycle appears to have ended and the crops reaped during the last two seasons have been reasonable. The current crop shows considerable promise."

"Good progress has been made in repaying industrial loans. Sugar consumption has continued to grow despite the poor performance of the economy. No additional sanctions have been applied to the industry during 1987 and 1988."

"Any one of them is significant. In aggregate they represent a remarkable change. It is time for the industry to look forward again."

Mr Ardington also drew attention to the degree to which the economy had become concentrated.

"There are only three suppliers of artificial fertilizers and you rarely have a choice of more than two suppliers of any particular packing material you may need. One organisation slaughters nearly all the beef which is allowed into our main urban areas," Mr Ardington said.

Huge expansion plan for sugar industry

Star 21/4/89
By David Canning

DURBAN — A huge expansion programme for the sugar industry which could inject R700 million into the economy and create 24 000 jobs, has been approved by the Cabinet.

The plans were outlined by George Bartlett, Deputy Minister for Economic Affairs, in Durban yesterday.

The expansion and deregulation programme includes provision for a new sugar mill near KaNgwane, free production areas for small growers within 30km of any mill, a 12 percent (300 000 tons a year) increase in sucrose production over the next five years, lifting of price controls at the industrial level and removal of quantitative import controls.

Mr Bartlett said the unrestricted import of molasses would be permitted, but that the industry would still be protected against dumping by foreign producers.

He said sugar production and marketing were highly regulated worldwide, resulting in its being one of the most distorted commodities in international trade.

Consequently, SA could not act in iso-

lation from the world community without causing harm to its sugar industry.

The plans fall into two categories: deregulation (including abolition of price controls) and expansion. In terms of the concessions, about 30 000 ha could be added to production.

Larger parts of KwaZulu could be turned from subsistence to cash-based economies.

The Eastern Transvaal stands to reap benefits, with approval for a potential new mill there and production concessions to KwaNgane and Onderberg.

The chairman of the Sugar Association (Sasa), John Chance, welcomed the announcement.

But he said the industry's expansion plans were based on an assumption that the proposed Richards Bay ethanol plant got the go-ahead.

Should this fail to happen, the industry would have difficulty implementing current plans fully.

He said the new phase of development would be accompanied by the removal of restrictive legislation and general reduction of Government involvement.

MAIL 28/4/89

"The Blue Train is not up for sale, it has never been offered to anyone and there is no likelihood that it will ever be put on the market.

"We didn't contemplate selling in 1986 when we were losing heavily on it, with occupancies dropping to little more than 30%. We're certainly not going to sell it now that occupancies are between 95% and 100% and the train is breaking even."

He says the train is fully booked until the end of the year and there is a long waiting list. More than 65% on the list are foreign visitors. ■

SUGAR INDUSTRY **3 SUGAR**

Milling around

It's a good public relations exercise — but is it deregulation?

The question stems from the unveiling of the SA Sugar Association's (Sasa) proposals to "deregulate" the industry and allow freer access to black growers.

Naturally, there's a price. As forecast by the *FM* (*Business* April 14), the main object of the exercise is to win government approval for construction of an ethanol plant.

Indications are that government is satisfied with the Sasa proposals and the cane-based synthetic fuel plant will get the Cabinet's nod within weeks. However,

concessions extracted in return appear to make little impact on Sasa's overall control of the industry.

Arguably, the two most significant proposals aimed at government approval for the plant are: scrapping quota allocations for small black growers within 30 km of the existing 15 mills and payment to small growers at the higher domestic price, rather than an average of A- and B-pool prices. All proposals are to be backdated to April 1. A small grower is defined as one producing less than 150 t of raw sugar, or sucrose, a year. Most of them are black and located in KwaZulu.

Quota allocations will remain in force outside the 30 km radius and for existing large (mainly white) growers.

By Sasa's estimate, so-called free production areas created by this move total 27 800 ha — mostly in KwaZulu. Assuming all the land is developed (which is highly improbable) KwaZulu cane production will increase by about 1 Mt, earning extra revenue of about R55m.

For their generosity in releasing the land, the sucrose quotas of existing large growers will be raised by 25 t a year. Sasa believes the combined effect of this increase and the potential new sucrose from free production areas, will raise raw sugar production by around 150 000 t a year.

Intriguingly, the land now theoretically available for increased production corre-

sponds with Sasa's own estimate of sugar lands lost recently to timber and urbanisation. But, whereas this newly-released land will take several years to develop, large growers may bring their increased quotas to the market almost immediately.

Another factor in measuring the merit of Sasa's deregulation is the fact that though quota regulations will be scrapped, small growers still require the advance approval of millers to expand into "free production areas." Approval will depend on the processing capacity of the mills.

Though Glyn Taylor, MD of C G Smith Sugar, and SA Millers' Association GM Ian Davidson believe that for practical purposes, capacity will not limit expansion into the free production areas, Sasa chairman John Chance concedes that, in theory, regulation may still be effectively achieved by controlling mill throughputs.

The real issue, however, remains the industry's 10-year campaign for an ethanol plant. Additional deregulation proposals announced last week, turn on this question.

It seems clear approval for the ethanol plant will be a pre-condition for Sasa's consent to build a new sugar mill in the Onderberg area of the eastern Transvaal. The new mill would justify developing an extra 3 500 ha of canelands in Kangwane, raising sucrose quotas in the area by 32 000 t and in the Onderberg area by 130 000 t.

Additional revenue to the agricultural sector will be R50m and R35m to milling.

Deputy Economic Affairs and Technology Minister Goerge Bartlett makes it plain government has the money available to build the dams needed to irrigate the proposed canelands, and would welcome the boost it would give to the regional economy. He says government's Central Economic Advisory Service is about to complete an investigation into the socio-economic impact of the proposed ethanol plant.

"I expect them to submit their report by the end of May, when government will consider this matter." ■

Cabinet approves far-reaching expansion programme

Sugar industry to be deregulated

DURBAN — A far-reaching deregulation and expansion programme for the SA sugar industry has been approved by the Cabinet, Economic Affairs and Technology Deputy Minister George Bartlett announced yesterday.

Among the more important aspects of the programme are the abolition of quantitative import control on sugar and molasses; unrestricted access to sugar cane production to any potential small cane grower; and the removal of restrictive land registration provisions for cane farmers.

The sugar industry has also been given full responsibility for determining the industry price of sugar and molasses — a function previously performed by government.

Bartlett said government believed that market forces would prevent the sugar industry from embarking on an irresponsible sugar pricing policy. The Government would determine the

BRUCE ANDERSON

broad parameters of the sugar industry's control over pricing, and the Trade and Industry Department would monitor the situation to ensure the sugar industry did not abuse its position.

The programme announced yesterday represents the complete acceptance by the Cabinet of proposals submitted by the SA Sugar Association (SASA).

The deregulatory measures would be made retrospective to April 1, Bartlett said.

Submission of proposals to the Cabinet committee on privatisation and deregulation was preceded by six months of discussion between SASA and government.



● BARTLETT

SASA chairman John Chance, who chaired the Press conference at which Bartlett made yesterday's announcement, welcomed government's acceptance of SASA's proposals.

Chance said a new phase of development would be accompanied by "an improvement in access to the industry, the removal of restrictive legislation, and general reduction of government involvement".

He was at pains to stress that government approval of an ethanol fuel-from-sugar plant would be crucial to the success of the expansion programme. He expressed the hope that Cabinet would approve its construction.

Bartlett said Cabinet would consider the viability of the ethanol plant at the end of May.

Chance said, if the new market in ethanol became a reality, a further expansion of new sugar producing areas in the eastern Transvaal and KwaZulu would be possible.

Such expansion would include the building of a new sugar mill in the eastern Transvaal at a cost of about R250m and the possible construction of a refinery at a cost of R50m, he said.

The benefits that were expected to flow directly from the deregulation proposals were substantial. They included:

- Expectations that sucrose production by the sugar industry would be expanded by 300 000 tons a year by the end of 1994 — a 12% increase over current production;
- Additional revenue of R55m a year and the creation of 13 000 jobs in the agricultural sector in KwaZulu and Natal;
- In the eastern Transvaal and KwaZulu — additional revenue of more than R15m a year to KwaZulu and the creation of 3 500 jobs; in Onderberg — additional revenue of R50m in the agriculture sector and R35m in the milling sector; and the creation of 8 000 jobs.

Sugar industry to hear plans for deregulation

DURBAN — The sugar industry will hear tomorrow how government is proposing to deregulate the industry, when Economic Affairs and Technology Deputy Minister George Bartlett addresses a Press conference.

It is expected it will be made easier for new cane farmers to enter the industry through an easing, or selective removal, of the rules on cane quotas and that the eastern Transvaal will be encouraged to open up areas to cane.

Bartlett may announce the industry can go

SUSA
ahead with its R80m plan for a Richards Bay plant to turn molasses and other sugar products into ethanol and sugar-related chemicals.

Recently, the industry signalled it was prepared to slacken its grip on entry to the industry should the government allow the proposed ethanol plant to go ahead.

Production statistics have not been published since certain foreign markets were closed to SA sugar exports but it is believed

that output is over two million tons a year and domestic consumption over a million tons.

However, the changes in the industry brought about by the 1982 decision that sugar farmers pay for cane transport and the split between a guaranteed price quota with the balance depending on the export price realised has shaken up the industry. Farmers over 30km from a sugar mill find transport costs onerous and slumps in the export price have persuaded many to re-consider growing export cane.

2/11/82 19/4/82

Own Correspondent

Rains save Natal's sugar cane

By Day 18/4/89
DURBAN — Natal's wilting sugar cane crop was saved by double the average April rainfall over the weekend.

The 150mm downpour was the first rain in more than a month, after far below-average falls in March.

Fifty-year figures kept at the Botanic Gardens give the March average at 133mm, but only 31,8mm fell last

3 sugar
month.

The April average is 81,9mm but the Botanic Gardens measured 151mm this weekend and the weather office at Louis Botha Airport recorded 143,5mm.

However, the rain caused tens-of-thousands of rands damage and washed out a number of sporting fixtures. — Sapa.

Tongaat: share for lean times

Few will dispute that the rand is a chronically weak currency.

It's the reason why rand hedge stocks have been so popular and why they're likely to continue attracting attention.

But as things stand, rand hedges don't come with a guarantee, principally because the looming downturn could offset much of the advantage inherent in them.

Tongaat Hulett is one company which meets both criteria: it is a rand hedge counter whose prospects remain encouraging, notwithstanding the expected downturn.

Tongaat's image suffers to some extent from its fall in earnings from 119c a share in 1984 to 24c in 1986.

Since then, however, it has recovered strongly, with the group recording another impressive advance for the year to March 1989.

Improved contributions from the sugar, aluminium and building materials divisions lifted turnover by 21 percent to R3,1 billion, while profit margins widened from 9,2 to 10,36 percent to produce a 36 percent gain in pre-tax operating profit to R327,5 million.

Earnings a share rose by 32 percent to 214,3c and a total dividend of 71c (54c) was declared.

For years Tongaat was viewed with suspicion because of its debt exposure. It is now much better placed.

Land and buildings were revalued in April 1988, with a consequent increase in non-distributable reserves of R488 million.

This, combined with the strong cash flow resulting from improved profit performance and tight management of working capital, cut

Diagonal Street
(3) Sugar
JOHN SPIRA



borrowings to R254,5 million at the end of March 1989 from R304,5 million a year earlier.

The reduced gearing is now reflected in interest-bearing debt, representing 15,7 percent of total shareholders' funds (30,4 percent a year ago).

Tongaat's main operating divisions are sugar, building materials, foods, aluminium and textiles.

The food interests are diverse, but the major proportion of turnover in this area is derived from such products as maize and animal feeds, which are subject to fierce competition.

Margins are low and profit increases in this division could therefore be modest in the current financial year.

The building materials division makes a variety of products — in particular, tiles and bricks.

Historically, it has experienced significant cyclicality in profits. Capacity utilisation is high and the demand for black housing strong.

The textile division continues to be affected by large-scale imports of fabrics and shifts in fashions. Nevertheless, profits could advance sharply this year, helped by the recent fall in the rand, which could encourage users to switch to local textiles.

Hulett Aluminium is the largest manufacturer of semi-fabricated aluminium products in Africa.

Profits have risen markedly in recent years. New capacity has been installed to meet growing demand and earnings could well grow again this year, despite the ripple effects of a slowdown.

The sugar division remains the largest in the group, accounting for 25 percent of total profits.

Domestic sugar production is expected to rise marginally this season, while exports should be boosted by the weakness of the rand.

The cream on the cake would be a rise in world sugar prices.

Analysts are unanimous in predicting that consumption will exceed production in the year to June 1989.

The shares yield 4,5 percent. Earnings and dividends should rise by a comfortable 25 percent this year.

Assuming the distribution rises to 88c, the prospective yield is 5,6 percent — an attractive return for an industrial company with blue-chip status.

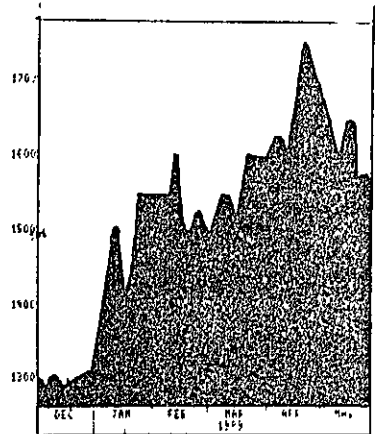

Source: Stock Market Solutions MAR 1989
Tongaat Hulett share price

Sugar industry awaits nod

Own Correspondent

DURBAN — The Sugar Association is hoping the Cabinet's decision on an ethanol plant will not be clouded by reports of investigations into the subject, says its president, John Chance.

He believes that parties with vested interests are continuing to delay implementation of the project by starting yet another investigation.

"If the project is not to be given the go-ahead there will be great disappointment in some areas of the country and in the industry, which would benefit greatly from it," he says.

Mr Chance was replying to the opening speech of Barlow Rand deputy chairman and chief executive, Warren Clewlow, at the annual congress of the SA Sugar Technologists' Association in Durban.

The mooted plant at Richards Bay is still under consideration by the Government, although a sizeable portion of the industry's current expansion plans hinges on it.

Mr Clewlow said the sugar industry's

effort to get authority to make ethanol as a fuel extender was the type of beneficiation project SA needed more of:

Without economic well-being, attempts to find solutions to socio-political problems would be stillborn, he said.

"With an unemployment rate of 50 percent or so, the ability to take decisions on our problems would simply be taken away from us, and in a way that we would not like."

He said that in the circumstances, SA's growth achievement and the repayment of R25 billion of its foreign debt were nothing short of incredible.

"South Africans have shown they can employ themselves, add value in manufacturing and create wealth.

"The constraints we are forced to apply to our balance of payments demonstrates the lunacy of our isolation."

Mr Clewlow said the high and rising rate of inflation was a weapon the country's highly sophisticated economic enemies were exploiting to considerable advantage.

Timber processors a 'threat' to canelands

Own Correspondent

DURBAN — Sugar growers have called for a moratorium on purchases of caneland by major timber processors while a study is made of the effects on the rural economy of widespread planting of forest on former sugar farms.

Tony Ardington, chairman of the Cane-growers' Association, said at the organisation's annual meeting at the weekend that the suitability of land for timber was seldom the criterion.

The land was being depopulated because of the less labour-intensive nature of silviculture, exacerbating the problems associated with urban drift.

He suggested consideration be given to limiting the accumulation of farms by processors of food and agricultural-ly produced raw materials.

Mr Ardington accused timber companies of restraining prices they paid to small growers.

"Increasing demand for timber, declining growth of existing forests because of drought and the lack of new supplies coming to the market have created a crisis," he said.

"The first response of the timber-processing companies was not to increase the price to the point where it became profitable to establish new land to timber; indeed, as recently as 1986 these companies were paying R44 a ton for timber delivered to the facilities (mills) by private growers while, at the same time, often paying in excess of R75 a ton to transport the timber from certain of their own plantations.

"Their response was to start indiscri-

minately buying up farms to establish timber.

"If, instead, they had increased the price of raw materials to the value reflected in the price they are paying for the farms, then the most suitable land would have been established for timber, leaving more productive land for crops."

That, he said, would have satisfied the needs of the timber industry and ensured the most economic use of land "without undermining the economy of the local sugar mills or the viability of rural communities".

Mr Ardington said the formula by which the proceeds of sugar production were split between growers and millers was penalising farmers at the expense of the milling companies because of the cost-savings achieved by producers over the past five years.

By responding logically to correct economic incentives, he said, farmers had held costs to an annual increase of 10,3 percent, considerably lower than that of millers.

Ironically, the formula gave a bigger share of proceeds to the sector with the higher costs; growers consequently had seen their share drop from 68 percent to 65 percent.

"It seems strangely inappropriate that an efficient response to hard times should now be depriving growers of much-needed revenue at a time when the financial position of the industry has improved.

"The consequences are far-reaching, particularly in view of the favourable alternatives offered by timber."

Sugar price prospects rosy ^{STW 2/17/89}

By Neil Behrmann

LONDON — Sugar prices surged to their highest levels in seven years last week as a result of significant purchases by the Soviet Union.

In London October raw sugar prices were trading above \$310 a ton, compared with \$210 a ton in January. The daily price has also hit record levels of about \$350 a ton.

In recent weeks the sugar market has been weak because of fears that China would not be able to buy the commodity.

But sentiment has changed and brokers expect the Chinese regime to be heavy buyers ahead of October when it will be celebrating forty years of Communist revolution.

A 200 000-ton purchase by a French merchant on behalf of the Soviet Union last week was sufficient to sweeten the sugar market.

Both the Soviet Union and China have been major factors in the sugar boom, which has carried prices up by 45 percent in the past six months.

Russian consumption of soft drinks, and hence sugar, has soared in the past few years, mainly because Soviet leader Mikhail Gorbachev has clamped down on sales of alcoholic drinks.

Instead, Soviets have bought more sugar to distill their own alcohol, while sales of soft drinks have surged.

Even though the Soviet Union is

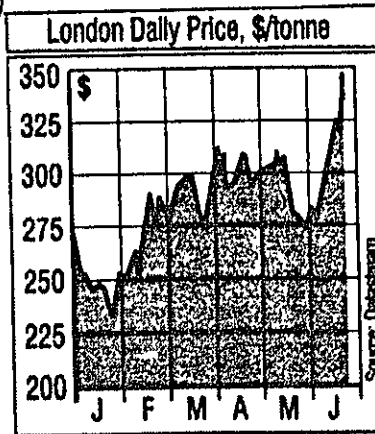

expected to produce 9,25 million tons of sugar this year, it must still import 4,9 million tons to meet consumption, says trading house C Czarnikow.

Most of Russia's imports are from Cuba, but supply shortfalls from time to time have forced the Soviet Union to buy from the West.

China's consumption is expected to soar to 8,2 million tons from less than six million a year in the first half of the decade, says sugar merchant ED & F Man.

This means that nearly four million tons must be imported.

SA sugar companies should do well out of the increase in values. The proviso is that they have not hedged their output on the London and New York futures market at lower prices. They should also gain from the weaker rand.

SA production is estimated to

rise to 1,45 million tons in the 1988/89 season from 1,37 million tons last year, the highest in five years.

Even though prices have rallied substantially, they are far below previous peaks.

In 1980, prices were up to \$1 014 a ton, but slumped to a low of \$45, equivalent to 2,6 US cents a pound in 1985.

C Czarnikow says that the world sugar supply/ demand balance has tightened in the past three months.

It estimates production in the season ending this August will be 106 million tons, but that consumption will be 109 million tons. This shortfall must be met from inventories.

But world sugar stocks are below the norm and if weather vagaries follow last year's patterns and again affect crops this year, prices could rise.

If prices rise to \$397 a ton, which is the support level for US domestic sugar producers, US sugar farmers will consider exporting surpluses.

Should this happen, there will be a shortage of sugar in the US and speculators could push prices even higher.

Volumes in New York, London and Paris futures have begun to increase, indicating speculators are entering the market.

Some sugar traders are predicting \$440 a ton or more in the coming twelve months. But prices are likely to be volatile.

Final 350 GMR

healthy profits on the export market while at the same time exploiting local consumers.

GM of the South African Sugar Association (Sasa) Peter Sale insists export pro-

year and about 8c the year before. In addition, Sasa's export revenue is compounded by high forex earnings as all sugar sales are in dollars.

There is now widespread consensus that sugar prospects have turned fundamentally for the better. And, while there will always be short-term price fluctuations on the world market, other trends underpin expectations of generally firmer longer term price levels.

The international sugar stockpile has been reduced from around 40 Mt to 20 Mt over the past five years through improved consumption. World consumption of nutrient sweeteners rose from 32 Mt/year in 1950 to 120 Mt in 1988. Growth of this magnitude augurs well for the future.

The short-term price movements are being affected by heavy seasonal buying from Russia and China, dry weather in South America which is causing problems for the Brazilian crop and the fact that India, usually a net exporter, has been in the market as a buyer because its crop has failed to meet expectations.

SA producers are looking at an "average" crop of about 2 Mt this year, half of which is exported. And, with Sasa having overcome its initial problems of sanctions on its exports in certain markets, Sales now says: "We're still managing to sell as much sugar as we produce."

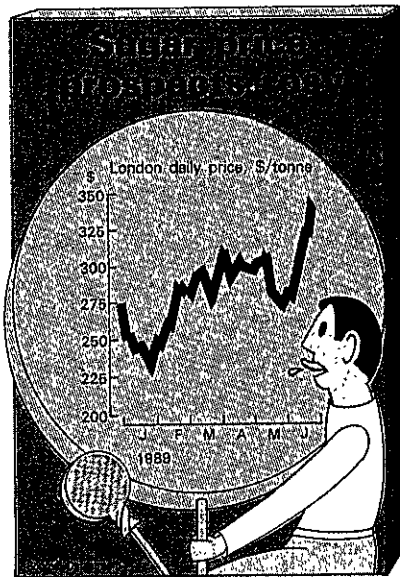

ceeds cannot be used to subsidise local prices. The local market is "separate" from the world market and prices are determined strictly in accordance with costs of production.

His view seems the converse of that used by the Maize Board (MB), which recovers export "losses" through higher local market consumer prices. In both cases, the arguments seem convoluted. But, at least, the MB has progressed beyond the stage where it relates prices to input costs.

Sale has already made it known that consumers can gird themselves for another inflation-related sugar price increase in August 1990.

But, while local consumers receive no respite, healthy export earnings at least help to redeem the industry's debt, which 18 months ago stood at R327m.

Several successive years of favourable crops and above average prices have enabled the industry to pay back almost 50% of its industrial borrowings (R100m in the 1987-1988 season and R40m in the 1988-1989 season). Sale predicts that if higher price levels hold — and there is every reason to suspect they will — the industry's debt will be reduced by a further R70m at the end of the current season.

London white sugar spot prices rose from US11,13c/lb on June 1 to 14,54c on June 30. This mirrors a similar movement in the middle of last year when prices moved from around 10,49c in June 1988 to a high of 15,83c in July, before settling back to around 11c in August.

Sale expects a similar correction to follow the latest price surge. "Invariably after a steep rise the price falls back. We expect it to settle down at around 12c-13c," he says.

That's still a substantial advance — considering that prices averaged around 10c last

SUGAR PRICES 350 GMR

Bitter and sweet

Sugarmen should be cock-a-hoop over the 30% surge in world sugar prices last month. They're not.

Two factors restrain them from breaking out the champagne: world sugar prices have been known to blip upwards before — only to fall back sharply. And the price increase, while extremely beneficial to the industry, couldn't have come at a worse time.

From August 1, the domestic sugar price will rise by 3,9%, the second of a two-stage price adjustment following the scrapping of price control earlier this year (in February the price went up 7%).

Coinciding with higher world prices, next month's increase is bound to lead to familiar accusations that the sugar industry makes

Retailers to defer sugar price hike

RETAILERS hoped to defer the 4% sugar price rise scheduled for August 1 as long as existing stocks lasted, spokesmen from three of the major chains said yesterday.

"Checkers will hold the price of sugar on the two major lines (the 2.5kg and the 12.5kg bags) for as long as possible," group deputy MD Sergio Martinengo said.

"Although 4% might seem minimal, consumers will feel the pinch as they tighten their belts yet again to accommodate the probability of an increase in the prices of confectionary and other sugar-based products."

A Checkers spokesman added that manufacturers of sugar-based products had mostly included this rise in their price calculations, but that the price of cordials would increase at the end of July.

6/Day 20/7/87 (3) SUSEV
CHARLOTTE MATHEWS

"We will not increase our sugar price until we buy sugar at the new price," a spokesman from OK Bazaars said. "We are trying to fill our stores so as to hold the lower price for as long as possible."

He said the OK would try to absorb some of the price rise, and its sugar price would only rise about 3.4%.

Pick 'n. Pay Supermarkets Food GM Alan Baxter said they would also hold the price down as long as stocks lasted. That would depend on the demand for sugar.

"Our price will go up 4%," he said. "We sell sugar at just above cost as it is."

Sugar, dairy products to cost more

③ ^{Sugar} Staff Reporter

The price of sugar is to rise by 4 percent from August 1.

The increase, which is expected to cause a ripple effect on all sugar-based products, was one of two increases announced in the Government Gazette in December last year. The first, a 7 percent increase, came into effect in February this year.

Mr Sergio Martinengo, deputy managing director of Checkers, said his group would continue to sell at the old price "for as long as our old stocks last".

He added, however, that increases in the prices of sugar-based products, such as sweets and cold drinks, could be expected.

Dairy products price increases are also expected soon.

Dr M N Herman, a spokesman for the NCD group, said increases in the costs of plastic and other packaging materials had forced increases in the price of most dairy products.

"Farmers also need the increase, especially when we consider how much feeding and transport costs have risen."

Dr Herman said the increases — which vary between seven and 10 percent, will affect dairy products in general.

New industry chief

3

^{sugar}
The Star's Foreign
News Service

BRUSSELS — Durban-born Mike Mathews is returning from Belgium to become the South African Sugar Association's executive director.

Mr Mathews, who takes up the post in November, says the changing political climate is a key factor in his decision to move after a spell as MD of the MAS shipping organisation.

"I never left South Africa for any political or social reasons, I was just offered a very attractive job. Now I have a very exciting challenge."

He says Europeans would be surprised to know that there are 22 000 independent black cane growers in the association, all getting assistance with

finance, marketing and export.

His first task will be to establish a more structured, systematic organisation, doing away with many committees.

"Rather than throwing problems at committees, we are going to have a formal management system and then try to make positive and proactive comments," he says.

Mr Mathews says if political progress continues and there is peaceful change, business prospects should be good.

"We could develop markets in Africa and improve the lot of poor countries."

Mr Mathews (55) is a former MD of Unicorn Shipping and the Grindrod Group.

Sugar chief pins hopes on R100m ethanol plant

BRUCE ANDERSON

ANNUAL proceeds from sugar and molasses sales now exceed R2bn, with exports accounting for R600m in the current season.

SA Sugar Association chairman John Chance added yesterday a planned R100m ethanol fuel-from-sugar plant was the key to expansion.

Stability of the sugar sector might otherwise be threatened by overexposing it to the volatile export market.

Chance told Sasa's annual meeting in Durban that expansion through an ethanol plant — about which government was expected to decide next month — would create more than 13 000 jobs, increase production for small growers and create opportunities for new small growers in KwaZulu and KwaZulu-Natal.

Sasa vice-chairman Glyn Taylor drew attention to the importance of improving the cane-to-sugar ratio.

He said the deteriorating ratio was not due to a decline in factory performance but to cane quality.

Chance said that, given high inflation, high interest rates, and extremely variable foreign exchange rates, the hand-

ling of money had become a vital part of the association's activities.

Almost all export proceeds are derived in dollars and the rand/dollar exchange rate was extremely important.

Chance said the weak rand had acted in Sasa's favour when it came to exports.

Our Durban correspondent reports Chance as saying that trends in timber made it "not difficult to foresee the day when a major sugar mill could be compelled to close" through lack of cane.

He noted the problem came from the economic effects of large timber-growing corporations offering high prices for cane farms and not paying private growers enough for their timber.

If sugar mills were surrounded by timber the effect could be disastrous.

"The local community would lose the entire mill workforce and its spending power; remaining cane farmers would be either compelled to incur increased transport costs to more distant mills or sell their land to timber processors;

agricultural employment opportunities would decrease by about 75% and urban drift would be accelerated; local commercial activity would stagnate and ultimately disappear; schools would close as pupil numbers declined and ultimately the entire infrastructure built around the sugar industry would decay."

Chance added this was already occurring in some mixed farming areas in the Midlands, and the "coastal sugar belt could be the next unless measures are taken to restore a degree of balance".

In view of this stark picture, Chance called on lumber processors to pay private timber growers prices "realistically related to final product prices".

He believed sugar industry experience had shown processors could always secure raw material supplies from private producers provided the price was right.

There was scope for timber and cane to co-exist to the benefit of farmers, millers and timber processors "provided we allow the action of prices in the product market to determine the allocation of land resources".

SUGAR. — 1990

Lonrho Sugar reports 11% growth in turnover

pl Day 28/12/90 (3) Sugar

CHARLOTTE MATHEWS

LONRHO Sugar Corporation, which is 99% held by Lonrho International, has reported turnover has grown 11% to 190-million emalangeni in the six months to September 1990 compared to 171,5-million emalangeni in 1989.

Lonrho Sugar grows and mills sugar at estates in Swaziland, Mauritius, Malawi and SA.

The figures are quoted in emalangeni as the company is incorporated in Swaziland.

Thomas Cook figures showed one emalangeni was equivalent to R1 for sellers and to R1,05 for buyers yesterday.

Because of the seasonal nature of its operations, the group's interim results are calculated by adding half the previous year's actual profits and half the estimated profits for the current year. The directors say actual figures would be misleading.

Estimated attributable profits at interim stage are 24,2-million emalangeni (23,3-million emalangeni)

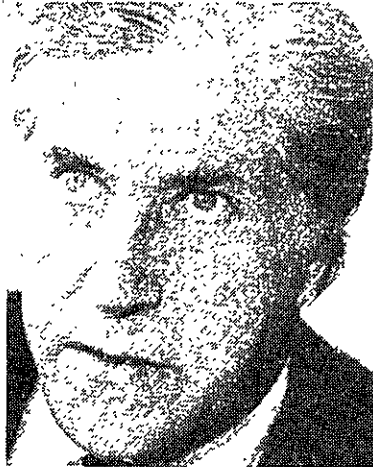

● ROWLAND

which translates into earnings of 215c (207c) a share on an unchanged number of shares in issue.

An interim dividend of 100c (75c) a share has been proposed.

Directors expect profits will be maintained at last year's level.

Although the world price of sugar has fallen, Lonrho has increased pro-

duction significantly this season.

A trader at Holcom Futures said yesterday the world price of sugar had fallen from a high of \$16,37c a pound earlier this year to \$9,9c a pound for March delivery.

"This year supply and demand are almost in balance but the price came off because crop estimates were changed from a deficit to a slight surplus," he said.

"World stocks are still at a historically low level and for that reason the price can find support at levels of \$9,9c a pound."

Recent speculation has linked holding company Lonrho International (which has interests in mining, precious metals, farming and industry) with Gencor, in a possible merger.

Lonrho MD and CE Tiny Rowland said if there was a merger, Lonrho would take over Gencor.

Gencor chairman Derek Keys subsequently denied a merger was being considered but said there were occasional discussions at divisional level "aimed at possible synergies between businesses in the two groups".

TONGAAT-HULETT

③ Sugar



FIM 30/11/90

THE EGGS IN THE BASKET

DIVERSIFICATION FROM SUGAR HAS NOT DELIVERED HOPED-FOR RETURNS

As with most agricultural products, sugar markets can be highly cyclical. More than 30 years ago Tongaat started diversifying into other businesses and today some of its other divisions rival the sugar interests.

But profit has remained brittle. Earnings crumbled during the mid-Eighties when the group was saddled with high borrowings. Now the board is forecasting a drop of about 25% at bottom line for the 1991 year. With these swings the diversification has hardly been a great success.

It was after Chris Saunders visited Hawaii in the Fifties that Tongaat Sugar Co first began to diversify from pure sugar interests. The Tongaat-Hulett chairman learnt how the Hawaiians used the by-products of sugar — molasses and bagasse — to produce animal feeds. This led to an animal feeds plant and a maize mill. Then, in 1968, Tongaat moved into chickens and mushrooms.

This was the beginning of what is now the foods division — which also produces edible oils, eggs and dehydrated foods as well as owning cotton gins, a warehousing and distribution operation and an industrial and commercial catering set-up.

Tongaat Foods is one of two divisions still performing well. The other is starch and sweeteners. The four remaining divisions are reporting reduced profits. Sugar has suffered from marginally lower international prices and a winter drought; aluminium from significantly lower world prices and a fall in demand; textiles from a change in import duty structures, political unrest and the downturn in the economy; and building materials from high interest rates, violence in the townships and a general lack of building activity.

Tongaat's figures for the half-year to September reflect the poor performance from most of its divisions though contributions are not released at the interim stage. Overall profit after tax fell 30%, compared with the first six months of last year, to R62,3m and EPS dropped 29% to 82,3c.

The outlook for the full year is not good despite the group usually performing better in the second half. Group financial director Ted Garner expects earnings to fall 25% overall. This

will result in full-year earnings of 177,5c — still better than the poor years in the recession of 1984-1986.

Garner says the group came out of that a lot leaner as it had to "cut everything back to manageable proportions," including staff. Even the company jet was sold. Return on shareholders' funds dwindled to just 6% in 1985 and 2,4% in 1986. At the end of the 1985 financial year EPS had fallen 48% to 60,3c and in 1986 dropped 60% to just 24,4c.

During that period, Tongaat also had the problem of soaring debt as borrowings for the newly built Felixton sugar mill came on balance-sheet. The debt:equity ratio rose to an uncomfortable 60,6%.

The group was criticised for not having a rights issue and letting return on assets fall to just 10% in 1986. "We made our assets sweat," Garner says. He believes that with the leaner structure and better debt position

— debt:equity ratio is around 25% — the group is better able to cope with the current recession. Though its half-year borrowings amounted to R620m, this will fall to R350m at financial year-end in line with the seasonal nature of the group's agricultural operations.

Though it is unfair to judge a company only on its performance during recessions, the purpose of a conglomerate is to spread its risks to ensure diversified interests are as contracyclical as possible. The question must be asked whether Tongaat has spread its risks sufficiently to produce steadily rising profits over a period. The six divisions are, however, 100% owned and mutually supportive in terms of cash flow.

EPS over the past 10 years have been volatile (see graph). The bad years were offset by some extremely good ones — in 1987 EPS rose 250% off a low base to 85,3c; in 1988 90% to 162,3c; and in 1989 32% to 214,3c. Garner points out that before 1985, the group had 11 consecutive years of good profits.

But Garner also says the business cycles of the various divisions have changed over time. When the group entered the building materials market it was because bricks and sugar were believed to be contracyclical.

Sugar has the potential to produce the steadiest profits — mostly because output is tightly controlled by government and major growers are restricted to annual quotas. Recent deregulation, which allows small farmers to grow without quotas, is expected to add small amounts to Tongaat's output. But the SA Sugar Association (Sasa) expansion programme, which will allow 300 000 t more annual production, will benefit mostly a proposed new competitor mill in the eastern Transvaal.

The only surprise could come from bad weather and international sugar prices, which did fall marginally this season though Sasa managed to sell most of the crop forward at a better price.

Just under half the sugar crop is exported and demand is almost static. With Reserve Bank Governor Chris Stals's pledge to keep the rand stable, it is less likely the industry will

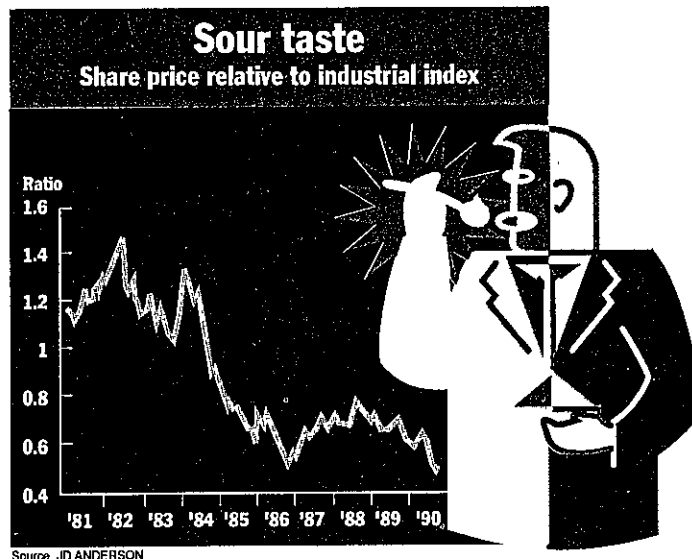
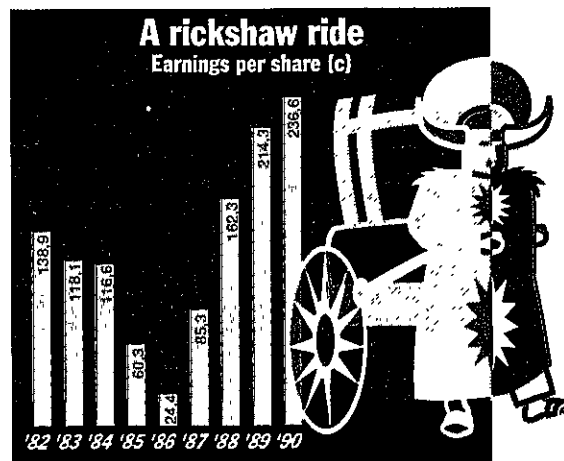

Source: JD ANDERSON

Flm 30/11/90

3 sugar

be able to rely on a depreciating rand for an added boost to profits. Demand from the local market, which receives about 1,3 Mt a year is, however, growing — especially from consumers as opposed to industrial demand. But Tongaat obviously cannot rely on this division for exciting growth. ^{3 sugar}

Hulett Aluminium, which at one stage overtook sugar as the largest contributor to profits, was the major cause for poor interim results as profits dropped considerably; 36% of Tongaat's aluminium production is exported, so the fall in the world price has hurt. Local fall-off in demand for building materials such as aluminium door and window frames has also taken its toll. Obviously lower volumes hurt margins. Garner would say only that though the contribution from

Hulett Aluminium is still substantial, it's not as it used to be.

The brick division, which falls under Toncorco, is operating at 65% capacity. Garner says because of the decline in building activity the division's brick stockpile is about 25m.

There is no telling when the building industry will turn around, nor when the enormous funds earmarked for black housing will be used, but Garner believes the building materials division is "the business of the future" and "is positioned for the upturn."

Tongaat Textiles, as a highly cyclical business, has always had its ups and downs. But unrest in the Mpumalanga township caused work force disruptions and a decline in local demand has hurt profits. According to Gar-

ner the introduction of low-priced fabric and yarn imports, because of a reduction in import duty, has increased competition and the hike in the price of cotton has pushed up operating costs. Whiteheads, which designs and manufactures furniture and clothing fabric, has tried to offset poor local demand with its export market — which is said to be large.

Starch and sweeteners division, African Products, continues to perform well despite competition from Tiger Oats, which has the benefit of its Beacon link. So far the Tongaat division has been successful and, according to Garner, paid for itself in three years — after tax. Afprod was bought from Amic in 1983 for 9,5m Tongaat shares and R3,1m cash.

Tongaat-Hulett is in the business of food, clothing and shelter. Everyone needs these but the strategy hasn't worked quite as expected. Instead of producing the steady growth one might expect from basic needs, profits have been erratic over the past decade. Investors are wary of the conglomerate, which has kept a low profile — probably something which has helped keep the share price well below the Industrial index.

The group still has to prove to investors that it can provide steady returns. Its 17,5% return on assets — after the revaluation of all group properties — is not as good as investors would like compared to the 21% interest they could be earning. It is an improvement, however, on 1986's 10% and only just below the 1988 high of 18,5%.

The interim dividend has been reduced to 23c from 26c and, as the half-year dividend is usually one-third of the total, shareholders can expect a final of 75c. Dividend cover will be reduced to 2,8.

The group is "sensitive to new business opportunities" which could come cheap in these times.

Tongaat has the resources to go shopping and Garner says debt would usually be used for this purpose but in some cases equity could be the form of payment. He says Anglo and Amic, which control 44% of the shares, have been supportive about Tongaat's purchase of assets. So there should be no problem from this quarter.

The problem lies in buying the right assets. It is no good opening textile factories to create employment; the business has to make money. However, demand for its present products could also surge in a renewed SA. If the promised houses and schools are built, building materials would be in strong supply. Houses would have to be furnished and fabric required. The question is when this will happen.

Tongaat-Hulett's share performance has long been disappointing. The price has reacted to the recent negative results by sliding to 1 250c from 1 900c in February. Perhaps Tongaat should look at other less cyclical businesses which will ensure shareholders their long-awaited return. It could also look at developing some of the land it owns.

Heather Formby

George Thomson
George Thomson
Assistant Manager

John J. Urquhart
Johnny Urquhart
Head Cooper

Stuart Thomson
Stuart Thomson
Mashman

Thomas Keith
Thomas Keith
Cooper

John Macdonald
John Macdonald
Cooper

John Murray
John Murray
Stillman

Johnnie Pater
Johnnie Pater
Mashman

Ian Macleod
Ian Macleod
Stillman

Stuart Macpherson
Stuart Macpherson
Cooper

Tom Anderson
Tom Anderson
Tractorman

Ian McIntosh
Ian McIntosh
Maltman

John Stout
John Stout
Cooper

Duncan Macpherson
Duncan Macpherson
Millman

Kenneth MacDonald
Kenneth MacDonald
Stillman

George Than
George Than
Cooper

George Mackenzie
George Mackenzie
Mashman

Murdoch Reed
Murdoch Reed
Distillery Manager

EVERY GREAT WORK OF ART
SHOULD BE
SIGNED BY THE ARTIST.

Handcrafted by the Sixteen Men of Tain.

THE GLENMORANGIE DISTILLERY COY TAIN ROSS-SHIRE

R300m sugar mill on way

(3) Suiker

By Ian Smith

STimes 4/11/90

THE sugar industry has not been cowed by rock-bottom world prices. At least two big producers are willing to build the first mill in six years — at a cost of about R300-million.

Barlow Rand's C G Smith and Rembrandt-controlled Transvaal Suiker are preparing their applications to put up a mill to produce 150 000 tons a year in the Onderberg region of the Eastern Transvaal.

The applications will go to the Government in about three months' time and a decision is expected in the first half of next year.

The mill will have to be supported by about 13 000 ha of cane, opening the industry to many new small-scale growers in KaNgwane and Onderberg.

SA Sugar Association chief executive Mike Mathews says expansion in Natal and the Eastern Transvaal will expand SA's 2-million-ton output by about 300 000 tons a year.

3 Sugar 80x 22/11/90

Tongaat earnings decline

By David Canning

DURBAN — Citing extremely difficult trading conditions, Tongaat-Hulett has reported a 29 percent slide in attributable earnings for the six months to September.

It has chopped its interim

dividend to 26c (29c).

Deteriorating trading conditions in both domestic and export markets led to attributable earnings of R61,59 million (R86,62 million) after a three percent increase in turnover to R1,92 billion (R1,86 billion).

The board says second-half

earnings should follow the traditional pattern of bettering the first half, but it still expects full-year profits to be down 25 percent from last year.

The uncertain socio-political climate and depressed economy, coupled with a deteriorating international situation, have affected current results and the outlook for the year.

Operating profit was down 24 percent at R146,1 million (R191,6 million).

A higher interest bill of R49,3 million (R44,7 million) saw pre-tax profit down 34 percent to R96,7 million (R146,96 million).

Earnings a share were 82,3c (115,7c).

The bottom line was helped by a drop in tax to R34,5 million (R58,21 million).

Two divisions — foods and starch sweeteners — improved their contributions to group profits.

The aluminium division suffered from the collapse of world metal prices, its contribution falling significantly.

Lower export prices and a reduced crop caused by a prolonged winter drought are affecting results of the sugar division.

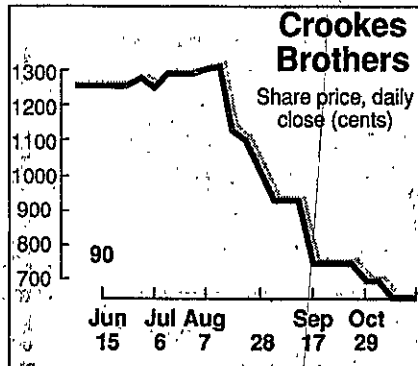

Graphic: LEE EMERTON Source: JSE

CBL earnings take an 'estimated' drop

16/11/90
MANDY JEAN WOODS

CROOKES Brothers Limited (CBL), an agricultural and investment holding company dealing mainly in sugar, has posted a 21% drop in earnings a share to 26,1 cents from 32,9c. (S) Sugar

In a statement, the company said its net bottom line profit had also dropped 21% to R3,15m for the six-month period to end-September this year from R3,9m last year.

The company notes that as its income from crops and investments is not received at regular intervals throughout the year, the interim figures are estimates for the current six months and the comparative figures are the actual for last year.

CBL's net operating income before interest rose 12% to R2,6m from R2,3m.

An interim dividend of 7,5c a share was declared, down from 12,5c last year.

Aluminium, sugar let Tongaat down

S/Times 25/11/90

(3) Sugar

By DON ROBERTSON

A FALL in world aluminium and sugar prices has caused Tongaat-Hulett Group to forecast a 25% decline in attributable profits for the year to next March.

Profits fell by 29% in the first six months to September on a 3% rise in turnover.

Aluminium prices dropped dramatically in the past six months, resulting in a sharp decline in the division's contribution to profits. The plant is operating at capacity. But because about 36% of production is exported, profits were severely dented.

World sugar prices are now showing signs of recovery. The crop was also affected by a long winter drought. In the previous year, these two divisions contributed about 40% each to turnover and profits.

Borrowings

Turnover in the first six months rose to R1,9-billion from R1,8-billion in the first half of the previous year, but operating profits fell by 24% to R146,1-million from R191,6-million.

The interest bill increased to R49,3-million from R44,6-million after a rise in borrowings to R628-million from R580-million. But because of the seasonal nature of farming, it is expected that borrowings will be reduced to about R350-million by the year-end.

This left attributable profit at R61,5-million, down from R86,2-million, equivalent to earnings of 82,3c a share (115,7c). The interim dividend has been trimmed to 23c (26c), cover being a reduced 3,5 times. The last interim was covered 4,45 times.

Aluminium and sugar were not the only divisions to be affected. The building materials division was hit by efforts to slow the economy, political uncertainty and township unrest as well as high interest rates.

The textile division suffered from a reduced demand for fabrics as well as large imports of fabric and yarn, the rise in cotton prices and labour unrest.

This was particularly

true at the Hebox plant, SA's largest denim manufacturer. Unrest at Mpu-malanga, where most of the employees live, caused production stoppages.

The food and starch and sweetener divisions increased their contribution to profit. However, it was insufficient to counter

losses in other divisions.

SA is facing an uncertain socio-political future and a depressed economy as well as a worsening international situation, making it difficult to forecast earnings, say the directors.

But trading is usually favourable in the second half and they expect a modest improvement, resulting in a decline in earnings of about 25% for the year.

WEEK IN BRIEF

A SUMMARY of the week's corporate announcements.

MONDAY: Interboard tells members it has recovered assets held abroad, including 120,35-million shares. Buildcor to raise R15,7-million 27 for 100 at 100c each. Interboard renounces its rights 32 for 100. Dicor offer to minorities opens 19/11, closes 7/12.

Drop Inn's sale of property to Berk family approved by general meeting. Greenfield Property suspended. Grovewalk says agreement has been reached to dispose of a material asset.

TUESDAY: SA Brews and Nedcor form Advantage Investment Corporation to serve clients.

WEDNESDAY: Safegro International Fund Management buys 49% of Mercantile Bank. Sub Nigel shares relisted, members warned. Interboard members approve changes.

THURSDAY: Woodrow, which bought the assets of Meter Systems including the rights to use the name, tells shareholders it is not connected with the listed cash shell Meter Systems.

Maxmech's controlling shareholders sell their stakes to Quad Industries at 10c a share, totalling R283 960. They will buy the assets for R500 000. Maxmech will buy Inom Industries from Quad for R3,96-million to be settled in shares and R500 000 cash.

Masterbore to raise R3-million through an issue of convertible debentures to reduce debt. Clegg warns.

FRIDAY: LDR for Focus dividend or bonus share offer is 7/12. LDR for Audiobuild, Abacus rights offers is 30/11. Audiobuild transmuted listing statement appears.

Romens to raise R3-million through 13% convertible prefs 64 for 100 at 35c.

Fintech will acquire 80,1% of a joint venture with Alcatel worth R22,5-million by the injection of STC Business Communications Systems. Alcatel will put in R7,4-million cash.

DON'T CALL US

AFTER WE ARE

SOLD OUT!



Sugar industry turns to small farmers

11/11 - 15/11/90
3 Sugar

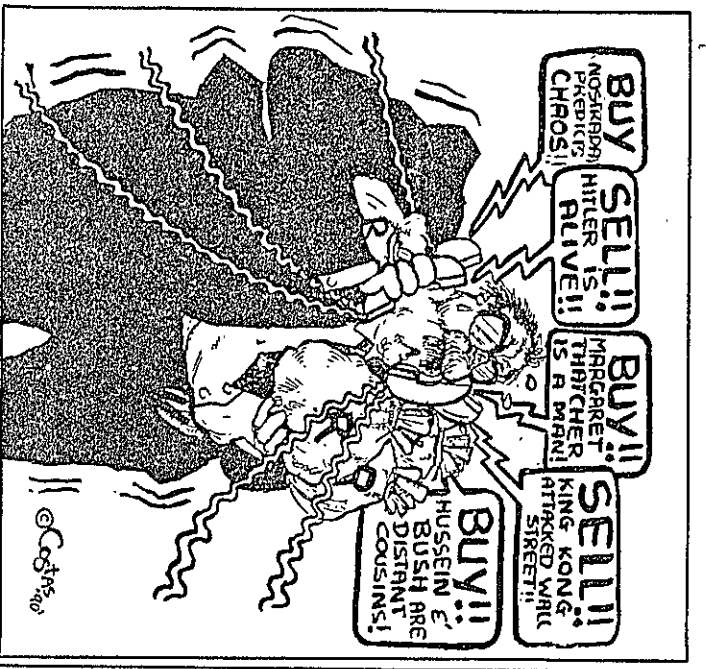

G.S.'s '80

KWAZULU'S land tenure system has been identified as the most crucial problem facing the increasingly important small sugar cane growers in the region.

Speaking at the labour consultation forming part of a "South Africa week" in Bad Boll, Germany, Deane Collins of the Trade Union Research Project at the University of Natal, Durban, said research indicated this traditional tribal land ownership system was the major problem hindering the development of small farmers.

Interviewed after Collins' talk, Brian Bannerman of Tongaat-Hulster's personnel division agreed. He said as far as management was concerned, "land ownership and tenure is the key issue".

Obstacles in the way of developing a healthy small cane grower sector are important because of the significant role sugar plays in Natal's economy.

South Africa is 11th in terms of world sugar production, with an average 2.2 million tons produced annually on 400 000 hectares of land.

The South African Sugar Association (Sasa) estimates 152 000 people are employed in the industry, with their families this means more than a million people are directly dependent on sugar.

Collins' paper outlined the problems faced by the small cane growers in establishing themselves as a viable and successful part of the sugar industry.

Describing the difficulties posed by the traditional land tenure system in KwaZulu she said development in the region had been superimposed on patterns of "tribal" land settlement which already existed.

"Plots for cultivation are given out by the chiefs. Land is not owned by the individual who farms it.

"This mode of land ownership is in itself a reason why small cane growers cannot get commercial credit and are therefore dependent on the services of the Financial Aid Fund (FAF)."

This has, in turn, curtailed the independence of small farmers.

The form of land ownership practised in KwaZulu has resulted in further problems — the division of land into small, uneconomic units, averaging a half to two hectares. "It is virtually impossible for a small cane grower to generate enough income from cane on a

plot this size."

Collins said the stated aim of the FAF, set up by Sasa, was to attract people back to the land and undermine the system of labour migrancy which is so prevalent in rural KwaZulu.

"Research has established, however, that this has not been the case. Because plots are so small, farmers cannot make an adequate living from cane farming.

"Members of families — mostly men — are still forced to seek employment in the towns to supplement incomes.

"Remittances from migrants working in the industrial areas and pensions are still the basic sources of income.

"As a result, most of the farms are run by women, children and old people."

She said KwaZulu had recently promulgated "a new Land Bill", expected to come into operation soon, in terms of which communities would be able to negotiate with their tribal authorities to obtain more secure title to land.

"This means successful farmers should be able to acquire additional land to expand and become more economic producers by consolidating small plots."

According to other research quoted by Collins, the new Bill attempts to "modernise without undermining the status quo."

"The power to allocate land gives political legitimacy to the tribal authorities. Under the new Act these authorities are given the power to hand out freehold rights. They are not however obliged to do so and are expected in many cases to resist any changes to the present system.

"KwaZulu chief minister Mangosuthu Buthelezi recently stated that the tribal authorities would continue to be at the heart of the KwaZulu administrative system."

As long as this is the case, "the potential for far-reaching changes in the land allocation system are remote."

Collins noted while the land tenure

system was the most important problem facing small cane growers, there were other difficulties.

Among these were the virtual monopoly over the industry by two companies, Tongaat-Hulster and CG Smith which together control 80 percent of the market and had forced the small cane growers into "a cycle of dependence".

She was also critical of the wages and conditions of agricultural workers in the sugar industry.

On the other hand the sugar industry has been facing a number of problems over the last 10 years, which "posed grave threats" to its survival.

One of these is the continuing inroads being made by timber companies which are competing with sugar for land, offering cane farmers very high prices for their farms. Both giant sugar companies have been forced to finance farmers and acquire farms to keep at bay the "timber threat", caused by the surge in foreign demand for timber and in the local demand for wood to feed the Richards Bay paper industry.

Cane growing is also under threat from rising costs.

To maintain profits, millers need to expand operations, but at a time when threats are growing to their supply.

Collins argued that the millers have turned to small cane growers to protect and expand their operations, and that the future expansion and viability of the Zululand sugar mills will largely depend on the success of increasing the production of the small cane growers.

Deregulation in the industry and the creation of "free production areas" within a 30km radius of the mills has created the potential for an additional 30 000ha which could increase KwaZulu cane production by two thirds — and mean work for an extra 10 000-12 000 small cane growers.

Sasa says these extra jobs will "significantly help socio-economic stabilisation in the troubled region".

However, Collins said if the small cane growers were really to benefit, it would not be enough to curd the power of the conglomerates and reallocate land with freehold title.

"What will be needed is a total re-organisation of production and distribution, involving a dismantling of the control which bodies like Sasa have obtained over the sugar industry."

Traders make a killings on rumours of Gulf war

By PAUL RICHTER, New York
OIL prices began ticking up in Singapore last month on a market rumour that Iraqi President Saddam Hussein was going to spend a day celebrating his birthday, and that American bombers were poised to rain devastation on Baghdad when he did.

Some traders expected the rumour to give the market quite a kick, but prices faded rapidly when somebody discovered Hussein's birthday had passed six months earlier.

The markets were also ruffled recently by talk that Hussein's astrologer had persuaded him that October 18 and 20 were auspicious dates to start a war. Then there was a rumour Hussein had been killed in a freak plane accident.

"Looking at the record, you just don't see moves from war rumours like what we've seen recently," says Robert Stovall, president of Stovall-Twenty First Advisers, a New York money management firm. "There's no precedent. There are good reasons for the rumours' exaggerated influence. The Persian Gulf threat simultaneously arouses anxieties of all the worst economic calamities: higher oil prices, inflation, and recession."

Compounding the markets' worries are Hussein's unpredictability, and the lack of reliable information from Iraq, both of which heighten the uncertainty that is always investors' worst fear.

War rumours have rattled world markets reminiscent to this century including

People covered in flame after Natal gas explosion

C/Item
7/10/90

3 sugar

DISPATCH clerk employed by
mes . Supermarket in Stanger, where
people died in a gas explosion on April
this year, this week described to a
nger inquest the horror of seeing a
n covered in flames, running helplessly
ards him.

Greesunker Sookdew told the court his
ly shook with fright when he saw the
n - a driver for the firm Sugar City -
ered in flames.

The Sugar City employee had gone to
lmes Supermarket to deliver a consign-
ent of gas in cylinders.

Sookdew told the court he was busy in
e storeroom behind the supermarket
en he heard a loud hissing sound.
hen he looked out to investigate, he was
rrified to see people in flames running
all directions.

There was pandemonium.

Sookdew said he did not know what
really happened, but ran for cover.

As he ran, he saw smoke and flames.
"My body shivered as I ran for cover."

From a distance he checked to see
whether his friend Perumal Govender
was safe.

Govender, who survived the blast, said
he was in the storeroom when he heard
shouts of "fire, fire".

A black employee ran into the store-
room covered in flames and he also deci-
ded to run out.

A short while later an explosion rocked
the area.

Twenty shoppers and employees died
either on the scene or later at hospitals.

The inquest continues. - Sapa

SUGAR F/M 12/10/90

A SWEET DEAL

3 Sugar

With the world sugar price likely to remain in the doldrums over the next year to 18 months, the sugar industry should be worried. But, apart from the eternal concern over seasonal production vagaries and the

volatility of the international market, it's not.

This is because most of the export quota of around 900 000 t was sold forward at prices significantly higher than the current world spot price. The SA Sugar Association, which markets the country's sugar abroad, has sold as much as 80% of this year's sugar exports at more than US\$300/t, well above last week's price of \$225/t. This has negated, at least for the time being, the effects of a world price that plunged to lows of less than US10c/lb at the beginning of August after setting 10-year highs last year.

The world price has bounced back slightly from the August low, but seems set to drift between 8c/lb and 12c/lb in the short term, says association CE Mike Mathews.

International marketing director David Hardy attributes the weak world price to the lack of activity in the market, but says he believes that taking into account the balance of supply and demand, the world sugar price is now too low. "What is needed is for the major buyers to enter the market — I would expect the Chinese or Russians to come on now that the price is so low."

Glyn Taylor, the association's chairman, believes that the world price will continue to drift in the current range, influenced mainly by global estimates showing a surplus of production over consumption. But he remains optimistic, saying the trend of world consumption growing by about 2Mt a year, roughly the same as SA's total annual output, should underpin international markets.

Mathews says the lower world price has not had any effect so far on the industry's expansion plans, which are linked to deregulation. Over the next five years a number of small farmers will enter the industry, pushing production up by between 260 000 t and 300 000 t.

"We don't feel any immediate effect because of forward selling," Mathews says, "and over the long term the world price should not affect our expansion plans."

Of more concern to the industry is a smaller-than-expected crop this season that, while offset slightly by higher sucrose levels, is believed to be as much as 100 000 t below estimates. The lower output caused by the dry winter means less sugar to sell overseas.

But the domestic market has been surprisingly buoyant so far this year. Taylor says local trading in the first six months of this year is 100 000 t ahead of the same period last year. "While this is largely due to stockpiling ahead of the August domestic price increase, we have nonetheless made significant gains over last year."

A potential boost to the industry's expansion plans came last month with the announcement from World Bank president Barber Conable in Washington that the bank was looking at pumping R1bn into

development projects in southern Africa.

While about half of the money is expected to go towards the Lesotho Highlands Water Project, Conable says — subject to final confirmation — that the bank was looking at the Komatipoort basin as part of an ongoing development programme.

Among the projects he listed is the construction of two dams, in Swaziland and SA, which fits with the infrastructure the sugar industry needs to boost production in the Eastern Transvaal and open a new mill. The infrastructure's R1bn price tag was the biggest obstacle to expanding the industry.

And while plans for the ethanol-from-cane plant, originally the reason for the expansion, seem dead, the Middle East stand-off

Not so sweet

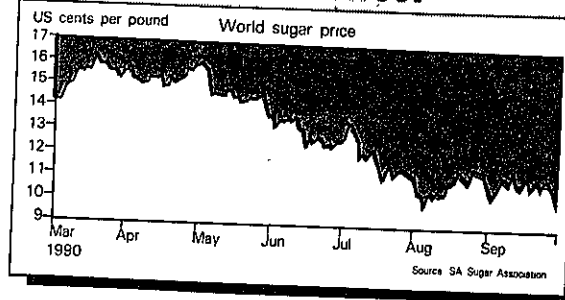

could revive the scheme. While government has made it clear it will no longer support synthetic fuel projects, a prolonged oil crisis could force a rethink.

Shaun Harris

Proposals invited for Onderberg sugar mill

By Peter Fabricius
Political Correspondent

The Government is to invite entrepreneurs to submit proposals for the building of a new sugar mill in the Onderberg region of the Eastern Transvaal and KaNgwane.

Trade and Industry Minister Kent Durr announced yesterday that the Sugar Association would shortly publish a press advertisement formally inviting applications.

Mr Durr said he was "enthusiastic" about the extra jobs that would be created and the possibility of establishing a substantial number of small cane farmers in KaNgwane.

But he cautioned that

the Government was not able to provide any guarantees that there would be extra irrigation water.

International agreements needed for the construction of irrigation dams had not yet been concluded.

Entrepreneurs considering investing capital in the sugar mill would have to "make their own commercial judgment".

These would have to be based on their assessment of the existing and future water supply situation.

Mr Durr said the introduction of free production areas for small growers had resulted in large numbers of these growers in the Natal/KwaZulu area entering sugar farming.

FIM 21/9/90

3 Sugar

According to Edwards, national forest plantations have increased by an average of 9,2% in the past 10 years and now cover nearly 1,2m ha. Capital investment has increased from R1,4bn to R6bn. Together with the growth in the forest products, the timber industry has shown a combined growth of just over 5% a year over the 10-year period, compared with an annual increase of just over 1% in real GDP.

Over the past seven years, the timber industry has also changed from a net importer of forest products to a net exporter.

In Zululand, the timber industry has a powerful impact on the local economy. Zululand's plantations make up just over 10% (or 140 500 ha) of SA's plantation area, but provide almost 15% of the country's total plantation output. Only 6% of the country's wood processing plants are in Zululand, but they consume over 20% of the country's timber.

By contrast, Zululand's sugar mills produce 700 000 t annually, with an estimated turnover of more than R520m. Of this, Mathews says, Zululand growers received in excess of R350m. So, while sugar still plays a significant part in the economy of Zululand, timber, as the new kid on the block, is becoming increasingly important to the region.

Sasa regularly emphasises the role it plays in providing employment in the region. On the other hand, claims are sometimes made that corporate afforestation leads to increased unemployment and ultimately the degradation of rural communities.

The forestry and forest products sector now provides 20 000 permanent jobs in Zululand, while sugar farming in the region provides about 26 000 jobs (the whole industry employs 152 000). But Mathews says, following the industry's deregulation and expansion moves, up to 7 000 new small cane growers should come into the industry in Zululand.

However Edwards, who argues that the timber industry not only provides jobs but constantly improves the level of skills and remuneration, says it is one thing "to create thousands of new jobs, but quite another to reduce levels of remuneration simply because of an excess supply of cheap, unskilled labour."

He says it is "the forest industry's desire to move away from the old system of what could be termed 'feudalism' or 'paternalism' to a system which encourages actual participation by labour in the economic system itself. Labour must become part of the wealth creation system."

He says it is "the forest industry's desire to move away from the old system of what could be termed 'feudalism' or 'paternalism' to a system which encourages actual participation by labour in the economic system itself. Labour must become part of the wealth creation system."

TIMBER AND SUGAR

3 Sugar

FIGHTING IT OUT

FIM 21/9/90

Change can be hard to accept — especially in agriculture, where resistance to market forces is often a way of life. That, in part, explains the often acrimonious dispute between Natal sugar growers and timber farmers over scarce resources.

Sugar has been Natal's principal crop for nearly a century. All that began to change about 10 years ago when corporate timber growers moved into the fertile coastal strip and midlands areas, buying up former cane land for afforestation, to meet the rising demand for timber.

Last week, at a public symposium organised by the Zululand Chamber of Commerce & Industries to debate the future of sugar and timber in the region, the two keynote speakers — Mike Mathews of the SA Sugar Association (Sasa) and Mike Edwards of the Forest Owners Association — went out of their way to stress the need for co-existence between the two industries.

But they did hit at each other with statistics.

Edwards says the forestry industry (free of statutory regulations and government support) has boomed over the past 10 years, and now contributes significantly to the national economy.

Though the sugar industry is now quickly moving towards deregulation and reduced dependence on government, it still suffers from the legacy of the days when it sought official protection and financial support. But, with both the domestic and international sugar markets picking up, expansion is going ahead — though not at the same rate as timber.



FIM 21/9/90 3 Sugar

Anne Vaughan from the University of Durban-Westville's Institute for Social & Economic Research maintains Sasa is not creating new jobs, only opportunities to supplement incomes. Arguing that most small, black growers farm plots too small to be economically viable, she says it is wrong to believe that cane growing could be the basis of any form of secure wage employment.

What is clear is that there is a transition from sugar to timber taking place in Zululand, and many other parts of Natal. And until market forces dictate otherwise, the process will probably continue — notwithstanding the protests of the powerful sugar lobby.

How sweet it is

After a troubled decade that saw floods and droughts, imposition of sanctions and a volatile world market, the sugar industry is looking ahead to stability and growth as both the domestic and international markets pick up.

In addition, the SA Sugar Association, which held its AGM last week, has undergone significant changes in the last year that seem to be paying off. Chairman Glyn Taylor says the association's restructuring is working well, with the industry's activities coming under the sharper focus of smaller, more expert groups instead of unwieldy committees. *FIM 318/90*

Deregulation over the next four to five years should create about 15 000 jobs and lead to the production of an additional 130 000 t of sugar as small, mainly black farmers are encouraged to enter the industry. Taylor says some small growers within 30 km of mills have applied to become cane suppliers.

Financing, however, is a problem. Vice-chairman John Chance estimates R50m will be needed to support the new farmers during the next five years and the building of dams and a mill near Komatipoort will demand another R1bn.

Expansion appears to suit the sugar indus-

75

try. Domestic sales for the new season stood at 448 000 t up to July 15, 28% higher than the same period last year. Manufacturers stockpiling sugar before this week's 13% price increase boosted sales dramatically.

Rebutting critics who continually call for lower domestic sugar prices, Taylor points out that the real price has declined since August 1985. He says that in the past five years the food price index has increased by 17% a year, the CPI by 15% and sugar by 13%.

Internationally, sugar is booming. The industry earned close to R700m in export sales last season, 55% above the previous record.

Taylor says sanctions have not prevented the industry from selling all of its export sugar and with no cut in price. Though plans for an ethanol plant — originally meant to be absorb additional sugar from the expansion spurred by deregulation — are now postponed, the association is confident it can export any extra sugar produced.

Another factor working in the industry's favour is that the world price for white refined sugar is higher than the domestic price for the first time in several years. The association is concentrating on an international swing towards buying refined sugar, which, over the past decade, has seen world white sugar markets grow from 27% to 39% of the total market of traded sugar.

To take advantage of the refined export market, the association is building a R13m bagged sugar warehouse at Durban's Maydon Wharf.

In his annual message, Taylor hinted that new markets in countries closer to home also seem to be on the cards. He said there was the promise of securing an important new long-term market in the region. It appears all that remains to be done is the signing of a formal agreement between governments. ■

Crookes investors approve share split

Own Correspondent

DURBAN — Shareholders of Crookes Brothers yesterday agreed to a four-for-one share split and the distribution of one C G Smith share for every four Crookes shares held. The new shares will be listed from August 20.

The divestment would lead to the reduction of about R1,223m in dividend income, but the dividend estimate of 75c (18,75c on the new shares) would remain firm, chairman Ian Gillatt told the shareholders' meeting. *8/0 a 9/8/90*

Gillatt said the purchase of four Eastern Transvaal farms was part of a long-term plan which would be enhanced if a proposed sugar mill in the area was commissioned.

No capital would be required yet, but the grant of a cane quota and a decision to turn the land to cane would require capital expenditure.

Interest and tax charges were expected to be higher, with the result that operating profits would be much the same as last year's.

Sugar's sweet five years

THE sugar industry is looking better than it has for the past five years.

It has ready markets and the world price has risen fivefold.

Debts of R327m incurred up to 1985 are expected to fall by R70m by the end of this season to R87m and improved cane transport has saved R118m in two years.

Although domestic sales

By DON ROBERTSON

are not expected to rise, the price of sugar will be increased by 13% on August 1. It will rise from R1 094 to R1 236 a ton. A kilogram of white sugar will cost 17c more and 42c extra for 2,5kg.

The industry selling price has risen by 11,3% in the past 18 months compared with

24,1% for the consumer price index. By announcing the increase early, the SA Sugar Association is giving industrial users a chance to build up stocks at the lower price.

SA Cane Growers Association chairman Tony Ardington says deregulation will reduce overheads, improve the use of capital and provide new farmers with ready access to mills.

SHE'S NUTS ABOUT BOLTS

By CHARMAIN NAIDOO



HAZEL MCGAW... the newcomer who quickly fastened on to a way of making a turn from fasteners
Picture: GARTH LUMLEY

HAZEL MCGAW is into screws. But she's also into nuts and bolts. In fact, fasteners of any kind excite her.

The blonde 48-year-old, who has turned her distribution company UTB Fasteners into a multimillion-rand winner, is happiest taking on her male competitors — and she has earned their respect.

Mrs McGaw has been elected chairman of the 50-member Fastener Distributors Association, which recently celebrated its first birthday.

She will liaise with manufacturers as well as customs and excise officials on duties and surcharges and make members aware of price increases and trends in the industry.

When English-born Hazel came to SA 18 years ago, the nuts and bolts business was the last thing on her mind.

"I got a job as a rep selling industrial fasteners, about which I knew nothing. I soon learnt."

Seven years ago she took a 5% stake in a new fastener company on the understanding that she would run it.

"Three years later my partner wanted to quit. I offered to buy his shares. I had no capital, and the Small Business Development Corporation told me that I was 'too white' for a loan.

SI Times 11/7/90

Gripe



"My bank manager laughed at me, a mere woman asking for a loan of R156 000. I asked my partner if I could pay him out of the profits. He agreed."

When Mrs McGaw took full control four years ago, turnover at UTB (short for Ultimately The Best, she says) was R70 000 a month. Today it is R250 000 and growing.

But she has a gripe: "We import most of our fasteners because they are of far higher quality than SA-made ones. We've begged manufacturers to make high-quality products and assured them that nearly all distributors will support them.

"Distributors don't want to pay the exorbitant surcharge and duty and would welcome SA products."

Under the umbrella of the FDA, she hopes to persuade manufacturers to "get off their butts".

"We have brass, copper, iron, steel — the material required to make fasteners. All we want is a reasonable product."

Sugar's sweet five years

SI Times 11/7/90

By DON ROBERTSON

THE sugar industry is looking better than it has for the past five years.

It has ready markets and the world price has risen fivefold.

Debts of R327m incurred up to 1985 are expected to fall by R70m by the end of this season to R87m and improved cane transport has saved R118m in two years.

Although domestic sales

are not expected to rise, the price of sugar will be increased by 13% on August 1. It will rise from R1 094 to R1 236 a ton. A kilogram of white sugar will cost 17c more and 42c extra for 2,5kg.

The industry selling price has risen by 11,3% in the past 18 months compared with

24,1% for the consumer price index. By announcing the increase early, the SA Sugar Association is giving industrial users a chance to build up stocks at the lower price.

SA Cane Growers Association chairman Tony Ardington says deregulation will reduce overheads, improve the use of capital and provide new farmers with ready access to mills.

Mrs McGaw admits that she knows little about finance — "I don't understand my balance sheets. My secret is that I do a daily cash flow and once a month I do an acid test — if we paid everyone what they are owed, what would be left? Have we made a profit? Sounds simplistic, but it works."

UTB carries large stocks — at any given time there are goods worth R400 000 in the warehouse.

Sugar price rise to cost soft drink firms R21m

³ Sugar
THE 13% increase in the price of sugar would cost the soft drinks industry an estimated R21,5m, SA Federation of Soft Drinks Manufacturers president Hennie Viljoen said on Friday. However, prices were likely to be unchanged at least until August.

Viljoen was responding to the SA Sugar Association's (SASA) announcement that the selling price of white sugar would rise by R142 to R1 236 a ton from R1 094 a ton on August 1. Brown sugar would rise by R129 to R1 122 from R993 a ton.

He said the soft drinks industry, which bought about 150 000 tons of sugar annually, was the largest industrial buyer of sugar on the domestic market. It consumed 13% of the total domestic annual usage of 1,3-million tons.

Bottlers customarily adjusted their prices once a year and would take the increase into account. There were 41 soft drinks manufacturing plants in SA.

"Although sugar forms a major part of the industry's cost structure, bottlers will absorb the price increases over a period of time," said Viljoen.

SASA announced a new pricing structure in December 1988.

"Whereas the previous situation was unstable, SASA said then that the price would increase by 7% on February 1 1989, with an additional increase of 4% in August, leading to a total of 11%," he said. The price would remain static until August 1990.

The SA Co-ordinating Consumer Council (SACCC) expects numerous price increases of sweetened goods, and encouraged consumers to purchase as much sugar as pos-

ACHMED KARIEM

sible before August 1.

SACCC director Jan Cronje said sweetened goods prices could only increase after that date and urged consumers to inform the council of any price increases of these goods before August 1.

"The prices of sweetened consumer goods should never escalate with the full price increase of sugar, because sugar is only an ingredient of these goods," said Cronje.

SASA chairman Glyn Taylor said the sugar industry had tried to keep increases as low as possible.

"However, the industry has escalating production costs and increasing salary and wage costs that cannot be totally absorbed by improved productivity," he said.

He estimated that consumer prices would increase by about 17c/kg for white sugar.

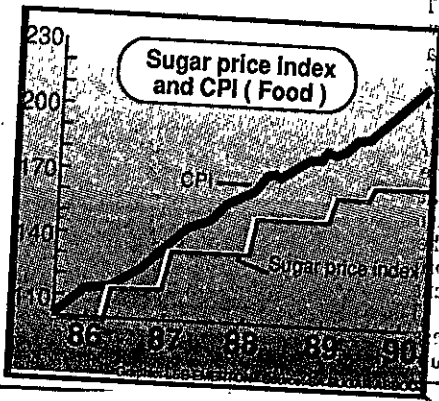

Tongaat-Hulett³ sugar to invest R250m

Own Correspondent

DURBAN — The Tongaat-Hulett group plans capital expenditure of R250m this financial year and has set up a unit to find new investment avenues, chairman Chris Saunders said in the annual report.

He said that maintaining and advancing the group's "competitive position in the diverse businesses which make up the group heads our list of priorities".

The first two months of the financial year had been difficult and the economic climate was not expected to improve in the immediate future.

He said it was unlikely earnings for 1991 would greatly exceed those achieved in the past year.

Earnings a share were 236,6c (214,3c) in the year to end-March out of which dividends of 79c (71c) were paid.

The report on the sugar division (pre-interest earnings of R76m) said sucrose results were "encouraging".

Domestic market sales were expected to stabilise and export prices, which had fallen to last year's levels, were likely to move within narrow limits.

The forecast was for a similar profit contribution this year.

The report noted that construction of an ethanol plant was "unlikely" but that the deregulation proposals for farmers within 30km of mills would benefit the group.

The building materials division (with pre-interest earnings down to R18m from R28m) forecast that the deliberate slowing of the economy and political uncertainty would affect product sales.

Sales levels and profit levels were expected to be similar this year to the

1989/90 contribution.

It was noted that considerable funds were heading towards the building market but were still held by government.

In March the Vitro brick factory at Springs was exchanged for Tongaat's 50% holding in Coverland. Two new production facilities were commissioned.

Tongaat Foods, with pre-interest profits at R29m, expected a substantial profit improvement this year.

The mushroom division would bring into operation a high technology farm at Shongweni this year, pushing capacity to where it could meet local and export demand.

Hulett Aluminium, with R70m in pre-interest profit, said in its report that as a major exporter it would be hard hit by the drop in prices and changes to export incentives, and expected an earnings drop.

The textiles division (pre-interest profits of R23m) faced a projected 36% cotton price rise, a downturn in local trading conditions and deteriorating labour conditions.

The first half of the year was expected to be difficult but it would look up later, increasing its contribution to group earnings.

Employees at the Hebox division at Mpumalanga faced severe unrest and violence and production and export orders were impeded.

African Products (R20m profits) expected increased demand to continue this year but it was unlikely that the same rate of growth would be achieved.

The division aimed to achieve a low-cost producer status.

SA equities' foreign sales rise in June

LIZ ROUSE

FOREIGN sales of SA equities speeded up in the latter part of June, according to the latest figures released by the JSE.

Sales increased to nearly R180,1m in the week ended June 22 from R141,4m in the previous week while purchases declined to R88,8m from R105,6m. This resulted in a net deficit of R91,2m (R35,8m) on foreign transactions handled through the JSE.

These transactions are a small part of total equity transactions of 60,5-million shares worth R493,8m transacted in the week ended June 22 (51,9-million shares worth R479,1m were transacted the previous week).

Foreign transactions in the gilts market remained steady, with purchases at R38,6m (R37,4m) and sales at R28,3m (R25,4m) resulting in a net surplus of R10,2m (R11,9m).

The weak gold price caused a sharp decline in the number of coins traded — 4 695 coins worth more than R4,4m changing hands in the week ended June 22 against 8 206 coins worth R8,3m traded on the JSE in the previous week.

150c) and R116,50 (up 150c) respectively. Mining houses made good gains, noticeably HAND MINES which closed

stocks like De Beers and Anglo. But price affected because of demand from

FIM 6/7/90

ers' president Hennie Viljoen, whose organisation represents 41 main plants, says a sugar price increase lower than the inflation rate is acceptable.

"But any increase in the price of sugar has a material effect on our industry — sugar is our main raw ingredient. The industry uses 150 000 t a year." He says the R142/t increase in the price of white sugar — to R1 236/t — will cost the soft drinks industry an additional R21,3m this year.

Costlier soft drinks

However, Viljoen says the increase will be absorbed for "as long as possible." When the price of soft drink does go up again, he says the industry will also try to hold the increase to under the inflation rate. In addition, the full 13% increase in the sugar price will not be passed on to consumers.

The last price increase in soft drinks — about 13% — was announced in March.

"Apart from sugar, we have various other increases — containers are going up by about 15%, negotiations with trade unions seem to be heading for an increase of about 17% in wages, and because of the vast transport fleet we run, fuel costs are always a factor," Viljoen says.

In the past, the soft drinks industry has investigated using alternatives to domestic sugar, like its counterparts in the US. But the high fructose corn syrup option didn't work out after the Tongaat-Hulett Group cornered that market. Furthermore, importing sugar from countries such as Swaziland, where Viljoen claims he could buy sugar for about R350/t cheaper, is precluded by industry agreements in each country.

Meanwhile, the sugar industry, which has been through two lean years in the domestic market, is cautiously looking forward to a better season. Sales for April stood at 108 000 t, 13 000 t above the estimate. ■

SUGAR FIM 6/7/90

Dearer prices

While any increase in the price of sugar has a notorious ripple effect on the cost of most foods and beverages, the SA Sugar Association's 13% increase announced last week is generally being greeted as reasonable.

More important, the deregulation away from government-approved prices and the association's new policy of announcing price increases well before they go into effect is welcomed as striking a more businesslike relationship between the sugar industry and its major customers. The price won't rise until August 1, giving manufacturers time to stockpile at the current price.

SA Federation of Soft Drink Manufactur-

Tongaat-Hulett braced for a more testing year

9/7/90 3 sugar

Finance Staff
Tongaat-Hulett is bracing itself for a difficult year.

While not prepared to forecast group earnings for 1991 the multi-faceted giant is not expecting a marked improvement in profit contributions of any of its six divisions.

In a bid to channel future growth over the long term the group is looking to investing in new spheres of activities and has established a business development unit to research and assist divisions in assessing opportunities.

"The first two months of this financial year have been difficult and the economic climate is unlikely to improve in the immediate future.

"At this stage it is difficult to forecast earnings for 1991, although it is unlikely that they will exceed those achieved in the past year," says group chairman Chris Saunders in the annual report.

Despite the uncertainty of di-

visional profit growth, the group has allocated R250 million for capital expenditure, of which R160 million will be spent on expansion, with the balance to be used for replacement.

"Underpinning this high level of capital expenditure, which will form the foundation for internal growth, is a sound financial structure and strong balance sheet," says Mr Saunders.

Mr Saunders says despite the difficult trading conditions and high rates of interest the group was able to show improved results.

Turnover rose 17 percent to R3,7 billion and profit before interest and tax by 14 percent to R373,56 million.

Attributable earnings rose R20 million to R177 million and EPS by 10 percent to 236,6c.

A final dividend of 53c was declared, making a total of 79c per share of the year, an increase of 11 percent, while maintaining dividend cover at three times.

"The year under review proved to be a very challenging one, with high interest rates, unrest and a definite slowdown in several sectors. In the circumstances, the groups's results are satisfactory."

During 1989 all divisions achieved improved profit contributions, bar the building-materials sector, which was hard hit by the slump.

The sugar and aluminium divisions showed significant increases in profit contributions.

Prospects for further marked improvement in these sectors in 1990 are, however, bleak.

Profit contributions in the sugar division are expected to mark time, while Hulett Aluminium is projecting a drop in earnings in the current year.

"Hulett Aluminium has become a significant exporter and the drop in world prices, coupled with recent changes in export incentives, will have a severe effect on profit," says Mr Saunders.

Profits squeezed

Tongaat-Hulett's turnover growth remains strong but in the past year the group was unable to maintain the rapid pace of earnings growth achieved since 1985. Management warns that financial 1991 will be tough but tempers that gloom by saying considerable capital expenditure and a search for new growth opportunities hold promise for the future. ⁽³⁾ Sugar ~~(1988)~~

The consolidated turnover was 17,4% up on fiscal 1989, reflecting strong growth in all divisions except building materials. This last sector contributed 13% to group turnover but its share of attributable earnings fell to 8% from 14% the previous year. The slump in the building industry adversely affected both

FINANCIAL MAIL JULY 20 1990

Activities: Operates in sugar, building materials, foods, aluminium, textiles and starch and sweeteners.

Control: Amic (23,5%); Anglo American (20%).

Chairman: C J Saunders; MD: T G Cleasby.

Capital structure: 74,8m ords. Market capitalisation: R1,31bn.

Share market: Price: 1 750c. Yields: 4,5% on dividend; 13,5% on earnings; p:e ratio, 7,4; cover, 3,0. 12-month high, 2 000c; low, 1 500c. Trading volume last quarter, 1,06m shares.

Year to Mar 31	'87	'88	'89	'90
ST debt (Rm)	79,2	63,5	56,7	87,5
LT debt (Rm)	301,5	241,0	197,7	237,8
Debt:equity ratio	0,45	0,33	0,17	0,20
Shareholders' interest	0,53	0,54	0,63	0,61
Int & leasing cover ..	2,4	4,3	4,4	3,9
Return on cap (%) ..	11,2	14,3	14,0	14,1
Turnover (Rm)	2 177	2 622	3 158	3 709
Pre-int profit (Rm) ...	177	241	328	374
Pre-int margin (%) ..	8,1	9,2	10,4	10,1
Earnings (c)	85,3	162,3	214,3	236,6
Dividends (c)	34	54	71	79
Net worth (c)	1 081	1 189	1 977	2 141

unit sales and profitability. The sugar and aluminium divisions, which each contributed 23% to turnover, both improved their share of attributable earnings to 32% (27%) and 30% (28%) respectively. The sugar division's profits were boosted by an increase in production, an improvement in the quality and sucrose content of the cane, better recovery at the mills and buoyant export prices.

The aluminium division benefited from strong domestic demand and international sales. But both demand and export prices eased in the second half of the year.

The food division contributed 26% to group turnover and its share of earnings remained constant at 12% despite a drop in margins. This was counteracted by a better mix of higher value-added export products and a rise in export prices.

The widespread unrest in Natal affected all divisions, particularly textiles which failed to meet profit targets even though its

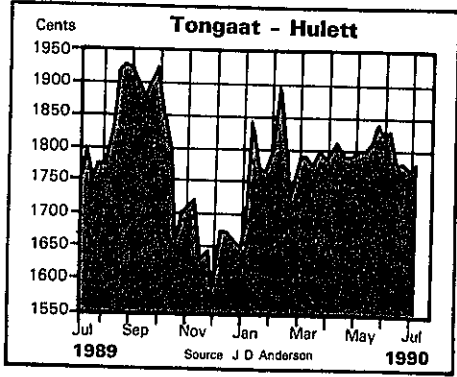

contribution increased. Higher interest costs cut into the group's operating profits to limit growth in attributable income to 12,7%, well below that achieved over the past few years.

Chairman Chris Saunders says "it is unlikely that they (earnings) will exceed those achieved in the past year." He expects the textile and starch and sweeteners divisions to contribute more to group earnings. A substantial improvement in this food division's trading profit is also expected but higher tax will limit its earnings growth. The performance of the building material division will stabilise while sugar's profit contribution should remain constant. A reduction in earnings from the aluminium division is forecast mostly due to lower international prices and the change in export incentives.

The group's growth potential will be bolstered by the high level of capex planned for this year and establishment of a business development unit to focus the search for new opportunities.

Pam Baskind

Star
26/7/90 3 Sugar

The Star

Finance

Aid needed for black canegrowers

By Des Parker

DURBAN — Capital grants and soft loans to help black canegrowers would be more appropriate for the new South Africa than sanctions against sugar exports to the US and Canada, says John Chance, vice-chairman of the Sugar Association.

He said at the annual meeting this week that with the deregulation of the industry, which had opened the door to an expected 8 000 small growers in the next five years, the association's financial aid fund needed an injection of R50 million.

More specifically, a dam was needed on the Umvoti River to supply the Mansomini and Sinamfini irrigation projects.

"There is ample land in the Umvoti River valley which could be irrigated and community advantages obtained if this dam goes ahead.

"What a pity that sanctions preclude the opportunity this offers for some great US foundation to play a role in helping the indigenous people of the area."

Mr Chance said the association would need to look at extending its refining and conditioning capacity because of the

growing preference of sugar-importing countries for refined sugar.

In the past 10 years, white sugar had increased from 27 percent of the total world trade to 39 percent.

The association had responded by building a R13 million warehouse for bagged sugar at its Maydon Wharf terminal.

A large increase in the price of molasses recently to bring it into line with its commercial value had led to expressions of concern, but the domestic price was lower than that of the imported product, he said.

● The sugar price had increased by only 13 percent a year over the past five years, compared with a 17 percent rise in the food price index and 15 percent in the consumer price index, said Glynn Taylor, chairman of the association.

Mr Taylor said: "There has actually been a reduction in the real price of sugar over this period.

"I should add that the domestic sugar price increase on August 1990, which has been pre-announced so that customers can take advantage of the old price, is also below the prevailing inflation rate."

By Dave Canaing

DURBAN —The Tongaat-Hulett Group experienced difficult trading conditions in the first three months of its financial year and its earnings are below budget, says chairman Chris Saunders.

He told the annual meeting on Friday: "It is too early to make predictions about earnings for the full year, but in present circumstances of high interest rates, work stoppages and poor trading conditions we shall not equal last year's record performance."

He said the economy, particularly in Natal, had faced a decline caused by interest rates, mass protests and unrest. These factors had eroded confidence.

Group divisions were trying to improve earnings through better productivi-

Star 30 1980

Tongaat Hulett feeling the pinch

3 Saunders

ty and cost-reductions.

This, however, was proving extremely difficult because of reduced demand and greater price competition in the depressed situation.

"The building materials and textiles divisions have both been particularly affected and our problems are further aggravated by lower world sugar and aluminium prices."

The group, however, had a strong balance sheet and was well placed to weather the storm, he said.

Transkei. The mills will accept cane from any small grower within a 30 km radius. At the same time, two or three dams and a new sugar mill near Komatipoort will have to be built. In theory, that would facilitate a 15% industry expansion, or an additional 300 000 t of sugar a year. But, in practice, several major obstacles still have to be surmounted.

Building the dams is subject to international agreements being concluded between SA, Swaziland and Mozambique. The dams would cost around R250m apiece; additional agricultural infrastructure R200m; and a new mill about R300m. That's almost R1bn that will have to be stumped up — mostly by government. But, in approving the expansion plans, government made it clear the money will not necessarily be automatically provided.

A further problem is financing the emergent small growers. Sasa's financial aid fund assists them with low-interest loans, but it operates on a first-come, first-served basis and resources are limited. Over the past 16 years, R45m has been paid out to small growers, R7,6m in 1989. But deregulation moves have now encouraged more small growers to come forward. Already the fund is looking at a drawdown of R16m in the current year — far more than resources permit.

Fund manager Richard Bates hopes to raise about R9m on the open market, but the problem is how to subsidise current high interest rates. Loans from the fund attract interest at only 12,5% — well below prevailing money market rates. Sasa has so far contributed around R6m to administering the fund, but cannot continue indefinitely with direct financial assistance. It will, therefore, have to look to other benefactors both in SA and abroad.

All these difficulties taken together preclude any rapid expansion of the industry. Says Rex Hudson, executive director of the Cane Growers' Association: "We know expansion is not likely to be implemented suddenly. There are too many external factors outside our control that bear upon it."

Meanwhile, the 1989-1990 season, which closed end-March, was a good one. World free market sugar prices hit a high of US16c/lb on March 16 and averaged around 13,8c/lb for the season. A favourable crop, yielding about 2,1 Mt of sugar and higher world prices resulted in improved revenue inflows.

Sasa executive director Mike Mathews says the industry paid off R69m on its industrial borrowings. Loan commitments now stand at R87m — much reduced from its peak of R327m — and Sasa should be in a position to pay off a further R35m this year.

The medium-term outlook also remains positive. Sasa expects world sugar prices to range between 11c-14c/lb during the current season. Though sanctions remain a problem, Sasa's existing world markets remain relatively secure.

But sluggish growth in the domestic mar-



Sugar ... reaching for the sky?

ket disappoints. Last year's total sales dropped slightly on 1988, against annual population growth of 3% a year. Mathews blames the low stock levels at retail outlets on high interest rates, the sluggish economy and political unrest.

Local sugar prices increased by 10% in the last 18 months and Mathews indicates another "inflation related" price increase can be expected by August. He says input costs are rising with inflation.

But the principle of annual price hikes should perhaps be re-thought. There can be few better incentives to spur domestic consumption than holding prices down. At a time when high export revenues look like being sustained, it surely is a marketing strategy worthy of consideration. ■

SUGAR FIM 29/6/90

Reaping goodwill ⁽³⁾ sugar

The SA Sugar Association (Sasa) is pressing ahead with its plans to encourage more black small cane growers to enter the market — without any guarantees that there will be an outlet for the additional sugar produced.

Sasa's initial idea was that government should support the building of a cane-based ethanol plant at Felixton, to mop up surplus cane and prevent the market being swamped by newcomers. But, because of the protracted studies into the feasibility of an ethanol plant and the pressing social need to involve more small growers, Sasa decided to push ahead with deregulation.

The expansion will primarily affect hundreds of small growers in the eastern Transvaal and KaNgwane, KwaZulu and the

^{(3) sugar} ^{Blom 28/6/90} Sugar industry says prices are 'too low'



● RIDGWAY

THE sugar industry could not continue to hold price increases below the rate of inflation without eroding margins, SA Sugar Millers' Association Limited (Sasmal) chairman Dick Ridgway said yesterday.

Addressing the association's annual

ACHMED KARIEM

meeting in Durban, he said that despite increased productivity, inflation and the high cost of finance would affect profits if prices stayed too low.

Despite domestic sales being down 35 000 tons compared with the previous year, the industry had every reason to be positive about its long term future.

More than 60% of total consumption was by lower income groups, he said.

"Future improvements in the level of disposable income of these groups, together with the rapid growth of our population surely constitutes an ever-expanding market opportunity."

Referring to government delay in accepting the industry's proposals for expansion and deregulation, Ridgway said this was due to the linking of the proposals to the erection of an ethanol plant for the production of motor fuel. This was subject to review.

R50m estimate for new sugar farmers

Own Correspondent

DURBAN — Up to R50m in new funding needed to be raised to help the estimated 7 000 new farmers expected to enter the field as a result of deregulation, according to an industry official. *By 2/11/70*

SA Cane Growers' Association vice chairman Lawrie Gordon-Hughes, at the organisation's annual meeting yesterday, said there would be new demands as a result of the changes.

The Small Cane Growers' Financial Aid Fund had already made more than R45m available to farmers since its inception in 1972, but would need that amount again in the next five years. *(S) Sugar*

Deregulation had put a question mark on the quota system and it was clear there was a need to review it with a view to introducing more flexibility and providing easier access, Gordon-Hughes said.

A vital issue was the intrusion of timber processors who had used their financial resources to achieve a foothold in "cane" areas.

Outgoing chairman Tony Ardington said labour relations on sugar farms was one of several areas that would change in the next decade.

Other changes would include the introduction of new cane varieties, better fertiliser distribution, increased concern about the environment, and reduction of cane burning.

Aug 21/6/90

3 sugar

Signs point to sugar industry becoming more labour intensive

By Des Parker

DURBAN — Sugar farmers have been urged to be more responsible both to their workforce, which is expected to expand considerably in the Nineties, and to the environment.

In a speech at the annual meeting of the SA Cane Growers' Association in Durban yesterday, outgoing chairman Tony Ardington said employment would tend to grow as capital investment became more expensive with the end of artificially low interest rates, subsidised investment grants and accelerated depreciation allowances.

"Capital will become increasingly scarce. Interest rates will reflect this scarcity.

"By contrast, the large number of unemployed will depress the cost of employment and various operations that are done mechanically today will be done by hand by the end of the decade," he predicted.

"I anticipate that once the time comes to replace equipment, the cost will prove prohibitive and that mechanical loaders will be replaced with people."

Trade unions

While the Labour Relations Act would have to be modified to meet the peculiar needs of agriculture, Mr Ardington warned that resistance by growers to changing industrial relations circumstances would attract the attention of trade unions "who will see it as their duty to bring agriculture generally into line".

What was needed was "happy farms"; workers should be given security of employment, of tenure of their homes and permanent access to schools and to pensions.

While the breakdown of racial barriers would have little impact on land-holding patterns in the sugar industry, developing relationships between farmers in densely populated tribal areas and those on freehold farms was "the most urgent task we all face".

Mr Ardington said while the sugar industry's ethanol plant proposal had all but foundered on opposition from oil companies and the Government's changed attitude to national fuel self-

sufficiency, production of the alternative fuel remained an essential part of the industry's strategy.

The export market was too unpredictable to guarantee adequate take-off of the additional 300 000 tons of production a year envisaged under the recently implemented deregulation and expansion programme. Sanctions, although less of a constraint, had yet to be lifted.

Ethanol as a petroleum additive also had environmental advantages, said Mr Ardington.

Growers heard that the domestic sugar market had been particularly disappointing over the past two years.

Price-sensitivity had increased and real income growth in the black community, which now represented the largest source of direct consumption of sugar, was being eroded by the burden of growing unemployment.

Increasing quantities

However, the domestic sugar industry was likely to be able to supply increasing quantities to the countries of Southern Africa, while progress had been made in boosting sales to manufacturers who previously used little or no sugar.

"While short-to-medium-term prospects are not encouraging, provided we can continue to decrease the real price of sugar in the decade and provided we maintain our competitive position in Southern Africa, growth of 20 000 tons a year, rising to over 40 000 tons, should be achieved," said Mr Ardington.

On the subject of environmental responsibility, the meeting heard that it had been decided to extend the voluntary ban by the industry on the use of hormonal herbicides, which were alleged to damage vegetables when they drifted onto market gardens from neighbouring cane farms.

Mr Ardington said farmers should consider reducing pre-harvest burning in their fields because of the environmental undesirability of the practice, at the same time as they made their farms increasingly accessible to the public "to enjoy the scenic beauty and tranquility of our farming areas".

10 000 new jobs possible

Aug 21/6/90

Finance Staff

Productive capital investment was needed in SA which would result in decentralised job creation, the generation of income and rural stability.

According to Mr Lawrie Gordon-Hughes, vice chairman of the Cane Grower's Association, the sugar industry had embarked on large deregulation and expansion programmes to meet the challenges of a changing SA.

At the annual meeting of the association, he said that the next few years would see the impact of the multi-million rand development of a completely new sugar project. This development would result in the establishment of about 7000 new small cane farmers and

bring the total number of such growers to about 39000.

This would result in the creation of over 10 000 new jobs and generate annual revenue to these areas of R250 million. These figures did not include the spin-off throughout the entire region in the field of machinery supply, transport services and community upliftment.

However, he said that although the Small Grower's Financial Aid Fund was established to aid new farmers, it would still need to raise some R40 million to R50 million to provide finance for small grower development over the next five years.

Sweet boost for the sugar men

3 sugar

Sta
18/6/90

By Clyde Johnson,
Lowveld Bureau

MALELANE — South Africa's sugar industry is to proceed with expansion programmes, though no decision has been taken on the proposed ethanol plant for Zululand.

Sugar association chairman Glyn Taylor, speaking at the weekend at the official opening of Transvaal Suiker Beperk (TSB) mill tourist centre at Malelane, said Cabinet approval had been granted last week.

But there was an un-

derstanding that international agreement would have to be secured before the construction of dams to supply additional water for the project could proceed.

However, he was confident that expansion would meet the various problems facing the sugar industry, and take place against a background of strong markets at home and abroad.

Production jump

Malelane's TSB mill had increased its production from 62 000 tons in

1967 to 200 000.

Its situation alongside the Kruger National Park was ideal for tapping the rich tourist traffic.

"We are confident that TSB's tourist centre will become a regular attraction as well as an educational centre for schools and other groups," said Mr Taylor.

The modern mill, which produces and packs refined sugar from the growing stage to the final product, offers tours on Tuesdays, Wednesdays and Thursdays.

Sugar expansion scheme approved

3. Sugar
BIDAM 7/16/90

LINDA ENSOR

THE sugar industry has been given Cabinet go-ahead to proceed with its expansion and deregulation programme although no government decision has yet been taken on the proposed ethanol plant to which the programme was initially linked.

Cabinet approval — obtained after a meeting between Trade, Industry and Tourism Minister Kent Durr and a SA Sugar Association (Sasa) delegation — was granted on the understanding that international agreements were concluded for dams to be constructed to supply additional irrigation water.

In terms of the package the industry will extend cane-growing areas in the eastern Transvaal and Kwa-Ngwane mainly by means of irrigation, incorporating thousands of small black growers into the industry. They will be entitled to send sugar for milling without first obtaining special permits under the quota system.

A new R240m mill near Komatipoort would have to be built to take up part of the estimated additional 300 000 tons of sugar which would be produced, at cur-

rent prices worth over R260m a year.

CG Smith Sugar and Hunt Leuchars & Hepburn's Transvaal Sugar have both tendered for the mill which would have an initial capacity for 130 000 tons of sugar.

Sasa chairman Glyn Taylor said the decision to go ahead with the plans had been influenced by pressure on traditional sugar cane land and confidence in sugar markets.

Initially the proposals were tied to the ethanol plant, which would take up

a large portion of the additional production.

Taylor said the expansion would also address problems facing the industry including the economic viability of some mills and spare capacity in others and it would now be able to make better use of its existing capital base.

Changes to the destination of sugar cane would allow mills to be used more effectively and in some cases would permit shorter travelling for cane.

With regard to the ethanol project, technical tests were still being undertaken and until completed the final feasibility and viability of the project could not be assessed.

A final decision to build the R80m ethanol plant at Felixton in KwaZulu could make further large scale expansion and deregulation possible.

Taylor said the industry has decided to proceed with the full expansion and deregulation programme to coincide with the start of the new harvesting and milling season.

As a result of the introduction of deregulation, farmers, mainly small cane growers, are preparing to produce new cane from the 1990/91 season.



● DURR

FIM 25/5/90 (3) Sugar (3) FIM 25/5/90

proved their contributions for the year. The result was that EPS rose by 10%, a growth rate that indicates a significant slowdown from the pace during the first half. Whereas in the first six months the bottom line grew by 16,3%, in the second six months the increase was only 4,5%.

Turnover for the year was only slightly ahead of inflation, with an increase of 17%, and the trading profit rose by 14%.

For now, the sugar price remains at high levels, so that division's profits still look promising for this year. However, financial director Ted Garner notes that the world aluminium price has dropped sharply from last year's peaks; the LME price is now around \$1 500/t compared with levels around \$2 200/t. Hulett Aluminium contributed 28% of group profits in the 1989 year, so earnings could well be sensitive to a weaker result from this division.

Several other divisions such as textiles and the building materials are under pressure as demand continues to slacken in the domestic economy, and it would not be surprising to see some declines this year.

Capital spending has remained at fairly high levels, with R200m spent last year, and the group's total interest-bearing debt rose by R71m, bringing the gearing ratio to 17,9%.

Garner does not offer any view on prospects before the annual report, except to say that real growth in earnings will be "very

STILL RISING

Year to March 31	1989	1990
Turnover (Rbn)	3,16	3,70
Pre-interest profit (Rm) ..	328,3	373,8
Attributable (Rm)	157,4	177,1
Earnings (c)	214,3	236,6
Dividends (c)	71,0	79,0

difficult" to achieve, which looks like an understatement.

At 1 810c, the share offers a dividend yield of 4,4% and looks fully priced.

Andrew McNulty

TONGAAT-HULETT

Less sweet

Tongaat-Hulett is among those groups which have benefited from booming commodity markets but is now feeling the pinch in some sectors as prices have eased and consumer spending has lost momentum.

In the 1989 fiscal year, the sugar and aluminium divisions became the biggest contributors to profits. Though divisional contributions are not quantified before the annual report, that trend evidently continued in the 1990 year, as the directors note that sugar and aluminium produced "outstanding performances."

Aside from sugar and aluminium, all the divisions barring building materials im-

FIM 11/5/90 (3) Sugar

SUGAR FIM 11/5/90 (3) Sugar

Bagging a market

Refined sugar has become more popular with foreign importers over the past 10 years, at the expense of bulk shipments, and it now makes up nearly 20% of SA's sugar exports.

To widen its niche in this market, the SA Sugar Association is investing R13m in a new bagged sugar warehouse in Durban.

The 16 000 m² warehouse will have a capacity of 57 000 t. It will be situated to the north of the bulk sugar terminal at Maydon Wharf. Work could start next month, depending on negotiations now under way between the association, Portnet and the Durban City Council.

The association's international marketing director, David Hardy, attributes the market swing to refined sugar to lower prices. These have made it cheaper to import refined sugar rather than erect refineries to process the bulk product.

However, this is no longer the case because refined sugar now costs between US\$80-\$100/t more than bulk sugar, compared with \$50/t a few years ago. So import-

ers, lacking updated facilities to process raw sugar economically, are riding out the high prices and waiting for the trough that usually follows a price surge.

This time, though, they could have a long wait. The local sugar industry believes that the world sugar price will remain high because, unlike the sharp upward peaks that characterised earlier price surges, the price has had an undramatic but steady climb to its current highs. The consensus is that the price could continue its upward trend for another 12-18 months as world sugar consumption consistently outstrips production.

"This is good for the country because it means the raw product is being processed here," says Hardy. "Right now it probably would be cheaper for importing countries to refine the raw product themselves. But they are obviously waiting for the price to drop again rather than erect refineries."

It seems the world trend towards bagged sugar is here to stay — if only for economic reasons. Thus a feasibility study carried out by the association recommended erecting a new storage facility rather than continuing to lease costly storage space. ■

Sugar warehouse to be built for R13m

THE SA Sugar Association is to erect a R13m warehouse designed to store bagged sugar cargoes at Durban's Maydon Wharf, international marketing director David Hardy said yesterday.

The building will have a capacity of 57 000 tons. *(3) Sugar*

Hardy said the volume of bagged sugar exports (compared to bulk sugar exports) had increased in the last few years as a result of changing interna-

ACHMED KARIEM

tional trends.

The ultimate size of the warehouse depended on negotiations with Portnet about the leasing of additional property, and with the Durban Corporation on infrastructural changes that would be affected by the leasing of the property.

It was expected that the volume of bagged sugar exports would increase in time, said Hardy.

RIP 4/1/90

sugar industry makes dent in support debt

12/1/70
LINDA ENSOR

THE sugar industry expects to have paid off R210m of its R327m debt, incurred when it took out price support loans, by the end of the March financial year.

Last year R140m of the government-guaranteed long-term debt was paid off, R100m from A. Pool proceeds and R40m collected in previous seasons. This last season a further R69m was set aside.

Nearly all the R327m was raised in US dollars, but cover was taken out at advantageous levels with the result that the SA Sugar Association (Sasa) has not and will not experience any currency losses.

The debt was incurred after severe droughts which saw a radical drop in sugar production of 600 000 tons out of a normal crop of about 2.3-million tons in the one season.

"The industry became fairly strapped and over a period of three or four years we used up the entire Stabilisation Fund of R95m which had been created in the '70s," says Sasa chairman Glyn Taylor.

Sasa then went negative by borrowing R327m and injected this amount into the price, thereby subsidising it and suffering an onerous interest burden which at the peak of interest rates reached R40m a year.

C
n
g
3
d
h
n

H
E
U
V

cl.
m
est
the
sig
DA
cat
LEI
Flo
and
bur

N4
IN
FR
id

3 sugar

COMPANIES

CE says Lonrho proud to be Africa's largest food producer

LONRHO'S proudest achievement is that it is the largest food producer in Africa, CE Tiny Rowland says in the British-based international trading conglomerate's latest annual report.

Rowland says Lonrho's holdings in Africa and the US together exceed 1.6-million acres, including extensive beef cattle ranches carrying 120 000 head.

Its African food operations include sugar estates in SA, Swaziland and Malawi, farming in Mozambique and Zimbabwe, food processing and distribution in Kenya and bottlers in Zambia.

The group, whose shares are quoted on the JSE, will always value its origins as an African mining and ranching company, he says.

"Throughout years of sometimes tumultuous political change in Africa, our experience has overwhelmingly been one of co-operation.

"Mining and agriculture are long-term investments which need sustained

SYLVIA DU PLESSIS

goodwill from governments over many years if they are to succeed."

Rowland says Lonrho's sugar estates — its largest single agricultural profit-earner — benefited during the year to September from the continued improvement in the world sugar price, with record profits being achieved.

Record

"In Mozambique we are one of the largest tomato growers in the southern hemisphere and the Lomaco estates are now the major supplier of vegetables to the capital city."

During the period under review Lonrho acquired Kenyan pork products supplier Farmers Choice and is now the largest pig farmer in the country, while Nigerian-based John Holt Farms commissioned a modern poultry plant outside Benin City with a capacity of 1 000 processed chickens per hour.

He adds that in Malawi tea production of 5-million kilograms was a "record" and prices were higher.

The group's other African-based operations include motor distributors, wattle estates, pharmaceutical distributors and construction companies. Mining interests are concentrated in SA.

Rowlands says gold and platinum group metal production reached nearly one-million ounces, and an improvement of more than 30% looks achievable due to the addition of a productive mine neighbouring Western Platinum.

The enlarged company is expected to market a third of the world's platinum group metals during the 1990s, he says.

Lonrho posted earnings a share of 29.8p (25.7p) in the year to September on turnover which rose to £5.1bn (£4.2bn). Dividends of 16p, 41% up on the previous 11.1p, were declared.

Rowlands says Lonrho, with 1 000 companies in 100 countries, is "well prepared" to expand into developing areas of Eastern Europe.

SUGAR INDUSTRY

Optimistic caution

One swallow does not a summer make. That's probably why Natal sugar growers are greeting the recent hike in world prices with caution.

They should be ecstatic. The sugar price has climbed steadily from around US9,5 cents/lb a year ago to 14,7c/lb on the New York futures market last week.

The sugar barons of Natal, however, have long memories. They recall painfully how the price spurted to a high of 45c/lb in late 1980 only to fall sharply a few months later to around 5c/lb. "We've been hurt before and we don't want to get hurt again," says SA Sugar Association executive director Mike Mathews.

The association would rather see a slow but steady rise in the sugar price based on an increase in demand over supply — as now seems to be the case — in preference to a heady rush to new highs. In its experience, sudden price surges are frequently accompanied by even steeper declines.

Some reassurance that the world sugar market is not about to enter another dramatic bull run comes from West Germany-based FO Licht's CE Helmut Ahlfeld. The head of one of the world's most respected firms of sugar statisticians is touring SA.

He says the international market is different to what it was during the euphoria of 1980 when speculators were a powerful force in trading. "Today about 50% of the sugar traded on the international market goes to developing countries. They can't afford 18c-20c/lb so, when prices rise, they cut back purchase drastically."

Another significant difference is that there's more beet sugar produced now than a decade ago. Beet is an annual crop — while there is an eight-year cycle for cane — so farmers can step up production quickly to take advantage of any sustained price rise. Rationalisation among Third World producers after years of low prices has led to lower production costs and the availability of dormant production capacity that can be brought back on stream should the market warrant it.

All this, Ahlfeld says, has led to major buyers — China, the Soviet Union and India — taking a cautious view. Apart from some sporadic tight periods the big buyers see the market easing and are reluctant to commit themselves to long-term positions.

So, in the short term, Ahlfeld sees the price fluctuating around 15c/lb but predicts

that, if political turmoil in the Soviet Union disrupts supply agreements with Cuba, or the weather in the major growing countries is poor, the price could top 25c/lb.

Mathews sees it the same way. He describes the market as "pretty fragile" and complicated by many factors. "You can't really tell where it's headed."

He sees the price moving at 13c-15c/lb during the next few months with, perhaps, a

quota lost several years ago to the Philippines. The association doesn't see this being handed back automatically but Mathews says any form of access to the US market would give SA the legitimacy it needs to maintain existing markets and develop others.

Even with sanctions, the association has found export markets — mainly Japan, Taiwan and Israel — for about 1 Mt. Export earnings are expected to be 39% higher per ton than the previous season and top R600m — highest in the industry's history.

Perhaps the most optimistic assessment comes from association chairman Glyn Taylor, who notes that world sugar stocks have shrunk from 40% of annual consumption a few years ago to 28,6%. Consumption worldwide is rising steadily by about 2 Mt/year but he predicts growers are unlikely to rush into additional production at current prices.

He adds: "There are indications that the demand-and-supply situation is becoming increasingly strained. If that is the case, we can only have prices moving higher." ■

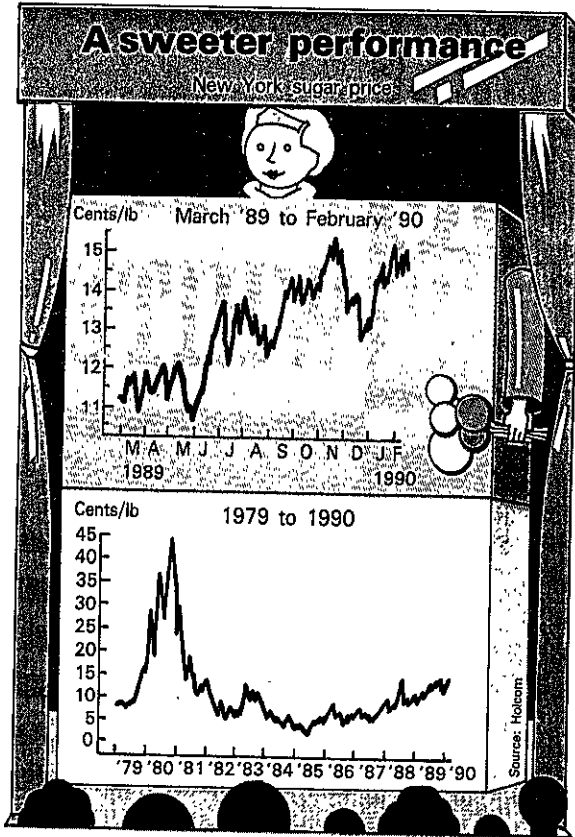

slight firming in the last quarter of the year.

Even at these levels the local industry is looking better than a few years ago. Several years of bigger-than-average crops, coupled with reasonable prices, has enabled the association to pay back at least half of the R327m debt it incurred when its price stabilisation fund ran out in the early Eighties. Last year it maintained that if the price trend held, it would be able to repay another R70m this season. That now looks probable.

The crushing season starts in April and, while it has been dry in some areas, particularly the lower South Coast, growers expect a good yield of sucrose and sugar.

Next month the association should hear whether government approves the proposed ethanol-from-sugar plant at Richards Bay. Viability studies are still under way but with government's new tough attitude towards synfuel projects, the industry shouldn't get its hopes up. Mathews says: "If the project is going to be dependent on government, it might not be a proposition."

With recent political changes the industry hopes to regain some export markets hit by boycotts, though the possibility of this happening soon is remote. The priority is the US

'Sugar price not as bullish as expected'

LINDA ENSOR

THE movement of the world sugar price in recent weeks and months had not been as bullish as the low international stock level would lead one to expect, Dr Helmut Ahfeld, CE of F O Licht, the world-renowned sugar statisticians, said in Johannesburg last week.

Speaking at a seminar organised by Holcom Futures, Ahfeld said the ratio of stocks to consumption was only one price determinant. He saw structural changes in the market resulting in a greater flexibility in both demand and supply, trends which lent support to the idea that there would be an equilibrium or modest rise in stocks in 1990/91.

"Assuming there are no production failures caused by the weather or political events, the expected moder-

ate increase in supplies will ensure a relatively calm movement of world market prices without great peaks or troughs, with a limited rise in stocks being likely in the near future," Ahfeld said. *BID 19/2/90*

"Weather-related or politically-motivated upsets on the production side would lead to notably higher world sugar market prices and also to stronger responses on the supply as well as on the demand side."

Ahfeld said the "great unknown" in the scenario was the evolution of Eastern European countries. If the social changes resulted in a better utilisation of their enormous sugar production potential, the world sugar

market would be plunged into a depression.

Ahfeld said the structural changes in the world sugar market in the last decade offered grounds to believe a further rise in prices might not occur.

He said it was quite possible the increase in production in 1990/91 could exceed the expected growth in consumption of 2.5-million tons, so that under normal weather conditions an equilibrium or a moderate rise in stocks could be anticipated.

"And it remains to be seen whether consumption will in fact increase by the expected 2.5-million tons."

Structural changes on the demand side included the growing percentage of imports by developing countries which would result in a more immediate response to higher prices.

Sugar shortage set to boost price

WORLD sugar prices are set to break 10-year records as world stocks are expected to shrink to a critically low level at the end of the 1989/'90 season.

The latest sugar stock report by internationally renowned sugar statisticians F O Licht of West Germany says an earlier forecast of an increase in world sugar production of about two-million tons has been revised, with an increase of only 700 000 tons being projected, due to worse-than-expected sugar crops in several countries.

World sugar production is expected to total 106,5-million tons compared with the September 1989 forecast of 107,7-million tons. Consumption of sugar is therefore expected to exceed output.

LINDA ENSOR

The report says despite a large beet harvest, USSR sugar production will not exceed 9,6-million tons, while China is thought unlikely to meet its 5,7-million ton sugar target. (3) Sugar

Holcom Futures chief trader Lindsay Williams says in a statement that the trends illustrate the vulnerability of the market. Bid at 11 21 90

"There is no comfort zone. Consumers needing sugar will undoubtedly be nervous on seeing this report and sugar now seems more likely than ever in the past to break free of its shackles and fulfil the potential we know it has."

Sugar price set to hit a 10-year peak

ALL the fundamentals are in place for the sugar price to rise to its highest in the past 10 years.

However, it is uncertain how the price will perform this year, says Lindsay Williams, chief trader at Holcom Futures.

Mr Williams says stocks are in a critical position.

Peak

As a percentage of consumption, stocks were between 28% and 29% at the beginning of last year and have probably declined to about 27%.

It is much the same as in 1981-82 when the sugar price rose to a peak of US45c a pound. The highest price was US65c/lb in 1970.

Mr Williams says: "But prices remain up to three times lower than then. In spite of the critical shortages last year, the price peaked at US15.38c/lb and by December had dropped to US12.78c/lb. The price has continued its marked up-and-down fluctuations.

By Don Robertson

"All that is needed to send the market flying is one very large purchase. This was evidenced early last year when Mexico made a 350 000-ton purchase and the price rose US1.2c/lb in a day."

Mr Williams says the inability of Third World or lesser-developed countries to pay for sugar is keeping the price down. Every time the price moves above a certain level, demand dries up.

"The question is whether this will happen again this year."

These subjects will be dealt with by Helmut Ahlfeld, chief executive of international sugar statistician FO Licht, when he visits SA next month as the guest of Holcom.

The SA Sugar Journal, quoting the Czarnikow Sugar Review, says that although the sugar crop in 1989-90 is

expected to increase to 107-million tons from 105.9-million in the previous season, consumption is expected to reach 109.5-million tons in 1990.

As a result, there is every prospect of a further draw-down this year.

"By the end of last August, carryover levels as a percentage of consumption had returned to those of 1980-81."

It is predicted that tight world sugar supplies could occur in the third quarter of 1990.

Weather

Russia imported about 2-million tons of sugar last year, and is expected to be a major buyer this year. Imports by China are also expected to increase this year, and India should require large tonnages.

Brazil, usually a large exporter, is likely to reduce its

sales on the free market because of bad weather and the need for sugar to convert into ethanol to power cars.

Poor weather conditions have also affected American and Mexican crops.

An editorial in the SA Sugar Journal says export prices have risen sharply from those ruling in the mid-1980s and earnings are expected to remain strong for some time. There is also the possibility that domestic demand will increase.

"The possibility of deregulation and of expansion linked to the industry's proposals regarding ethanol production suggest an exciting prospect for a dynamic new era in the '90s."

The prospects for a bumper season in SA are good. Rainfall in the five main growing areas in the second half of last year was well above the same time in the previous year.

S/Times 28/11/90

3 Sugar

100

1044

AGRICULTURE — SUGAR

1991

Cane farmers optimistic

DURBAN — Most cane-growers in SA's sugar belt were optimistic about the season's crop, but were hoping for some warmer weather between now and April, SABC radio news reported.

Cane Growers' Association chief agricultural economist Brian Sugden said most areas had had good rains. However, the Natal Midlands, hit by a cold, dry winter, had had little rain, and a lot of cane which would have stood over for this season was caught by frost and had to be cut early.

The arid Pongola and Malelane areas had sufficient irrigation water, while in Zululand, the Umfolozi Co-operative was expecting a better than average crop, or even a bumper harvest if conditions warmed.

Sugden said the past season had yielded less sugar than the average of 2,1-million tons, but that this season's yield should be close to that figure. Sugar farmers ought to do fairly well in 1991, although a forecast lower world price and increasing production costs could mean a drop in net income for many.

The world price is about 22 US cents a kilogram, compared with about 33c a year ago. — Sapa.

SUGAR INDUSTRY (3) Sugar
SOUR OUTLOOK FM 18/1/91

Things have turned grim for the SA sugar industry. In the last few months the world sugar price has plummeted from last year's high of more than US\$350/t free-on-board to less than \$200/t. And if rain doesn't come soon for Natal sugar growers, this season's crop could be severely hit.

Glyn Taylor, chairman of the SA Sugar Association, says the outlook for the season starting April 1 is "not particularly good." In addition to the nearly 45% drop in price, the rand has held steady against the dollar, so growers have not been able to reap the extra earnings in rands that a falling rand had produced in the past. In the last few weeks, though, the rand has weakened as the dollar grew stronger in the run-up to the Gulf deadline.

Taylor attributes the lower world price to:

- The forecast of another production surplus, though a small one, for the year ending in September. Global production is expected to exceed 112 Mt;
- Weak demand as a result of the Gulf crisis and the chaos in the USSR; and
- The move by China — which has been a major buyer — to cut its imports significantly.

Taylor says the demand for SA sugar is likely to outstrip supply owing to its good quality, but prices will be well down on last year.

"In the domestic market, sugar sales are expected to show only moderate growth because of the recession. This aside, a repeat of the current season's estimated 50 000 t sales increase is not expected because there were a number of one-off favourable factors at work last year." Domestic sales are expected to reach 1,3 Mt this season.

BUSINESS & TECHNOLOGY FM 18/1/91

(3) Sugar

Taylor says it seems the recovery experienced by the industry over the past two years is "fast running out of steam."

SA Cane Growers' Association GM Rex Hudson concurs and adds that the poor economy, along with the current unrest and violence have also had an impact. He says it's difficult to predict a crop size at this stage, but the situation looks gloomy because there has been "a lot of cloudy weather and not that much rain."

Hudson says time is running out for growers in Natal and a few more hot days and little rain could cause serious problems. He says good rains in December, January and February are vital for the industry. "It is getting to the stage where we need rain very badly. We are reaching a sensitive stage."

Des Woodroffe, deputy manager for the Tongaat-Hulett Group, says that if prices stay down for some time, sugar mills will start to feel the bite. But he notes the market is volatile and things could suddenly improve. Only a few months ago, he says, things were fairly rosy.

Taylor says the downswing won't affect the new mill planned for the eastern Transvaal. Tenders for the project are now circulating.

Price fall to sour sugar exports

S/Times 20/1/91

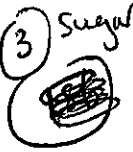

THE TWO-YEAR mini-boom for sugar is fast coming to an end.

World sugar prices have fallen from a 1990 peak of more than \$350 a ton to below \$200. SA exports, which make up about 37% of total sales, will be hit.

Aggravating the problem is an expected minimal growth in domestic demand and a rand which is projected to remain fairly stable against the dollar for the rest of the year and reduce export earnings.

In spite of poor prospects, the industry plans to go ahead with its expansion programme which will include additional cane-growing areas in Natal and the Eastern Transvaal and building a sugar mill and refinery near Komatipoort at a cost of R300-million.

Rain

Although long-term predictions are difficult to make, lower income from the sugar crop could affect companies such as CG Smith and Tongaat-Hulett.

Both companies earn between 17% and 20% of their revenue from sugar.

Glyn Taylor, chairman of the SA Sugar Association (SASA), says the outlook for the season starting in April is not good.

Although most of the cane-fields have received reasonable rains, more is needed. Industry sources believe that in best climatic conditions the crop could be about 2-million tons, compared with about 2,15-million in the past two seasons.

They say lower production will be experienced mostly by farmers producing B pool cane which is largely destined for export. This could cut export earnings by as

By DON ROBERTSON

much as R75-million at current prices.

World sugar prices have dropped in spite of poor crops which are expected to yield about 112-million tons in the international season to September. Demand is forecast at 110-million tons, leaving an overhang of 35-million tons from previous years.

China is not expected to be a major consumer this year, because of its shortage of foreign currency.

The SA industry is, however, flexible and able to adjust to changed circumstances. In the past two good years SASA was able to cut its commercial loans — raised to see it through previous difficult times — from R327-million to R87-million.

Industry experts believe that at the end of the current SA season in March, about 750 000 tons of sugar will be available for export compared with 800 000 in the past two years.

Mr Taylor says SA is not facing a "wipe-out, we have faced these problems before".

Tenders

He says expansion will continue in Natal. It has also started in the Onderberg-KaNgwane area of the Eastern Transvaal where the mill will be built.

CG Smith and Transvaal Sugar Corporation have tendered for the right to build the mill and refinery, but the go-ahead is expected only March. It will take about two years to build the mill, by which time it is expected that prices will have improved.

Mr Taylor believes prices will be more stable in the 1990s.

Another bid for Umfolozi sugar mill

MARIETTE DU PLESSIS

DISCUSSIONS are taking place on the Tongaat-Hulett Group's possible acquisition of a sugar mill owned by Umfolozi Co-operative Sugar Planters, a statement published today said. *Day 1/2/91*

Neither party would comment on the nature of the deal.

However, Tongaat-Hulett PR manager Ron Philips said the negotiations were concerned with the same mill which the group had tried to acquire in 1979. That bid was unsuccessful after Umfolozi Co-op's members voted against it. *(3) Sugar*

Expansion

Philips declined to comment on details or the amount involved, since "negotiations are in the very early stages and all the co-op members have yet to be approached".

In July last year, Tongaat-Hulett announced that it planned capital expenditure of R250m for financial 1991, of which R160m would be spent on expansion.

At the time it had also set up a unit to find new investment avenues. Since then Tongaat-Hulett has, through its foods division, acquired the Farm Sunrise Group which manufactures a range of packaged soups, meat marinades and Weight-Wise products.

Sugar mill hinges on finance

A R1bn Eastern Transvaal sugar farming expansion programme hinges on World Bank and additional international funding of dam construction in Mozambique and Swaziland.

SA Cane Growers' Association executive director Rex Hudson said the World Bank had announced in October that it was looking at pumping R1bn into the Komatipoort basin and Swaziland, among other projects, as part of a continuing development programme.

③ Sugar
Operational

The expansion programme included a new R250m sugar mill planned for the Onderberg region, two dams in Mozambique and Swaziland respectively at a cost of about R500m, and additional agricultural infrastructure estimated at R200m.

SA Sugar Association (Sasa) chairman Glen Taylor said yesterday that the mill, which would be the second in the region, could be operational by 1993 if government

MARIETTE DU PLESSIS

gave the go-ahead before end-April.

While the mill's starting capacity would be 130 000 tons of sugar annually, its potential after full development of water reservoirs could be 300 000 tons.

A total of 3 000 ha had been earmarked for cane planting in Kangwane in anticipation of the new mill, indicating an additional 32 000 tons of sugar annually.

Hudson said government had agreed in principle to the planned expansion, but gave no undertaking on the availability of water as negotiations were taking place with Mozambique and Swaziland.

The final submission date for bids for the milling licence closed on Monday, and would be evaluated by the Sugar Industry Planning Advisory Committee before recommendations were made to the Minister of Trade and Industry, he said.

The three contenders are C G Smith Sugar, Transvaal Sugar Corporation and Inkomati Sugar Milling.

R/P 004 1572/91

Sugar exports to earn less as crop hits a low

3 Sugar
5 times by 1991

EXPORT revenue from sugar sales is expected to fall by 21% in the season to March and the crop will be the lowest for six years.

Nevertheless, the industry will be able to reduce its price support loans by R31,5-million to R87-million by March from R118-million last year.

The SA Sugar Association told an agricultural conference in Pretoria this week that sales would be about 6% higher than in the 1989-90 season.

Because of drought in the northern areas, final cane production was 7% below the early estimate. Both the sucrose content at 12,9% and the ratio of cane to produce a ton of sugar at 8,92% were below the exceptionally good results of the previous season.

Turnaround

As a result, sugar production would be about 130 000 tons lower than the average for the past six seasons. The amount of sugar available for export would drop because 65% of production was needed for the domestic market.

Sales had shown a strong turnaround from the downturn of the past two years. Sales in the 1989-90 season were 3% lower than in the previous year because of high interest rates, inflation and the slowdown in the economy.

Wholesalers and retailers were forced to reduce stocks by up to 50%. This in turn prompted restocking at the start of the current season, although sales eased later.

By November sales were back on track and to date were 10% higher than last year.

The association believes sales for the full season will

By DON ROBERTSON

be about 6% higher than in 1989-90.

Major increases in production, particularly by India, have halted the trend of the past four years of consumption exceeding production.

Third World countries have cut purchases because of a lack of foreign currency. This affected international prices which fell from US16c a pound in May to US10c in August.

The average price for the season to date is about US11c a pound compared with US13,84c in 1989-90.

The SA industry, however, used hedging facilities and covered most of the 1990-91 crop at levels prevailing last April and May.

In spite of achieving better-than-expected export prices, revenue will be down by about 21% in the current season.

The association says the winter was dry, but spring and early summer rains were good. Should good rains continue for the rest of the season, production should at least be maintained at current levels.

Peaks

Export prices are depressed and unlikely to reach previous peaks. B pool sugar, which relies only on exports, is expected to bring in less money. A pool sugar, largely domestic based, may be marginally better in price.

But extra money will be needed to reduce loans.

The industry plans to continue with its expansion programme in KwaZulu, Kangwane and the Eastern Transvaal and a R250-million sugar mill is being considered.

The increase in the area under cane will result in a 300 000-ton rise in production over five years.

Sugar's prospects sweeter than price

11419 SEAN VAN ZYL

WHILE crop prospects for sugar in the new season beginning in April could produce a 10% improvement in yields, the world price remained volatile and at a low of about \$200 a ton, the SA Sugar Association's chairman Glyn Taylor said yesterday.

Taylor said that international sugar prices had dropped from a peak of \$357 a ton last season. "I don't expect a significant turnaround in the price in the immediate term."

As a result, Taylor added, the lower international prices would mean a considerably lower producer price for B pool cane and sugar in the current season, while there had been a build-up in surplus sugar.

However, Taylor noted that "the crop prospects for the new sugar season are quite good and could yield a 10% improvement over 1990/91".

The industry was also successful in reducing its price support loans to R87m from R118m in the last season to March. This season's target would be to reduce the amount to R57m.

He said the recent signing of a long-term contract to supply 46 000 tons a year to Botswana would be a major boost to the local market.

Bumper sugar crop and hefty price rise likely

By Des Parker

^{(3) Sugar}
The domestic price of sugar is likely to be increased later this year by a figure close to the inflation rate, according to SA Sugar Association (Sasa) chairman Glyn Taylor.

The last increase, of 13 percent, took effect on August 1 last year, at which time the annual inflation rate was running at about 13,5 percent. By February this year the official rate was closer to 15 percent.

Mr Taylor said at a Press conference that the real (after inflation) price of sugar had declined in the past five years.

"We will need to raise that rate to somewhere closer to inflation to cover the rise in production costs," he said.

World market prices have slumped over the past year and little improvement is seen for

^{Star 11/4/91}
the short-term, with a surplus replacing the previous deficit because of bumper crops worldwide and fewer buyers.

Mr Taylor listed as major contributory factors chaos in the Russian distribution system, continuing sanctions on Iraq (which used to take 600 000 tons of sugar a year) and foreign currency constraints in China. In addition, India and Thailand produced bumper crops.

On the domestic front, Mr Taylor said March had been an excellent growing month and the current season — which began on April 1 — could yield a 10 percent bigger crop than the 1990-91 season did.

Good rains and generally favourable growing conditions in Natal and the Eastern Transvaal had sweetened the outlook for the industry.

Production last year suffered

from the effects of winter drought. However, this meant every available ton had been sold and good prices had been achieved by successful hedging in both the sugar and foreign currency markets.

The industry sold a record 1,3 million tons on the local market last season, 5,7 percent more than in the previous year. This was the biggest growth for a long time.

"Manufacturers of products containing sugar increased their offtake by seven percent and particularly good growth was recorded in the soft-drink industry," said Mr Taylor.

A long-term contract to supply Botswana with its sugar requirement had been signed.

Botswana previously imported its sugar from Zimbabwe but bad weather adversely affected the sugar crop there.

Fm 12/4/91
SUGAR INDUSTRY (3) Sugar

HOW SWEET IT IS

Low world sugar prices and surplus stock on international markets don't offer much encouragement for SA Sugar Association (Sasa) exports, but there's a sweetener in the form of a 10-year supply contract to Botswana.

The deal will result in about 46 000 t being railed to the neighbouring state next year. This is a fillip for a domestic market that saw record sales of 1,3 Mt in the season that ended on March 31, says Sasa.

The association does not reveal contract prices but, going by the current industry price on the domestic market, the extra 46 000 t would be worth about R56,9m. The price paid by Botswana, however, will almost certainly be lower.

Demand from Botswana is also likely to grow. Sasa national market director Frans Oosthuizen, who was involved in the six-month negotiations with Botswana's State-owned Sugar Industry Ltd, says authorities there forecast a 5% growth in the market.

He adds: "They are hard bargainers but very businesslike and professional. We're

Continued →

BUSINESS & TECHNOLOGY

Fm 12/4/91 (3) Sugar

both happy with the agreement." Oosthuizen says a truckload of sugar was recently sent to Botswana for sampling and the reaction was good.

SA stopped selling sugar to Botswana in the early Sixties, after which Rhodesia, and later Zimbabwe, supplied it. Zimbabwe has, however, had bad droughts recently.

Under the new agreement, Botswana will switch its packing operation from Francistown to a new plant closer to SA at Lobatsi.

The 46 000 t is about the same amount of sugar that the SA industry supplies to Namibia annually.

Reviewing the past season, Sasa chairman Glyn Taylor says domestic sales showed a 5,7% increase over the previous year to make it "the highest growth rate for a long time."

He adds that manufacturers using sugar increased offtake by 7%, with particularly good growth in the soft drinks industry. Last year they used 150 000 t of sugar.

Taylor says crop prospects for the current season are quite good and could yield 10% more than the past season.

But the world price is not encouraging. Coming off a peak of US 16c/lb in May, the price is now at about 9c. After years of deficit, the world stock balance is now in surplus.

The present strengthening of the rand is also adding to pressure on export revenues.

But it's not all gloom. Last season Sasa sold every available export ton at good prices because it had much success in selling its production forward early in the year when international prices were still high.

Shaun Harris

Sugar price increase to have ripple effect

Star 4/6/91
By Paula Fray
Consumer Reporter

The sugar price increase announced yesterday may prove a bitter pill for consumers to swallow as the higher costs filter through to the numerous products in which sugar is used.

"There will definitely be a ripple effect," said Housewives League president Lyn Morris.

National Black Consumers Union president Noma Ramphomane described the increase as another knock for consumers.

The Sugar Association announced yesterday that the

industrial price of sugar in 250 kg quantities would rise by 13 percent on July 1, bringing the price to R1 268. This represents an increase of R160.

Consumers can expect an estimated 19c increase for 1 kg or 45c more for 2,5 kg. At present sugar costs about R1,80 a kilogram.

South African Sugar Association chairman Glyn Taylor said the industry had tried to keep the price increase below the inflation rate, which is running at 14,8 percent.

"South Africa is still being plagued by high rates of inflation and low growth rates. The sugar industry has been adversely affected and it is difficult to keep costs and

selling prices down when the industry itself is faced with higher costs," he said.

The industry says it has announced the increase to give the trade and public an opportunity to stock up before the price increase.

Referring to the Sugar Association's statement that the increase was below the rate of inflation, Mrs Morris said that if everyone gave increases just below this rate, inflation would never come down.

Mrs Ramphomane added: "One wonders what is going to happen after September 30 when VAT is imposed."

She said she had still not heard how the Government would give food aid to the poor.

15 000 new jobs expected in ^{③ SUGAR} sugar industry

THE government expects about 15 000 new jobs to be created in the sugar industry as a result of ongoing derulATORY efforts.

The major thrust will come from measures "for freer entry and expansion of production" according to the Department of Trade and Industry's annual report, tabled in Parliament last week.

It was initially decided that these should be introduced subject to growth in the industry and the success of the ethanol from sugar project.

In the light of "improved local and international market conditions" the situation was reconsidered and it was decided to go ahead with the full package of measures.

"Additional production resulting from the measures will, when fully developed, amount to some 300 000 tons of sugar per annum, while approximately 15 000 new employment opportunities can be created," said the report.

It added that the free production areas for small growers that have been established within 30 km of existing sugar mills had created new opportunities for cane farmers in underdeveloped rural areas.

COMPANIES

Sugar saves Tongaat from sliding further

16/5/91
 16/6/91
 NATAL-based Tongaat-Hulett's sugar interests helped the medicine go down, but this was not enough to remedy a 19% drop in earnings to 190,6c (236,6c) a share for the year to end-March.

A poor performance in non-core divisions saw turnover up 2% to R3,8bn (R3,7bn) while trading profit was down 15% to R317,6m (R373,6m). At the bottom line earnings were down 19% at R142,6m (R177,1m). The total dividend was reduced 8% to 73c (79c).

The year's performance was ahead of the 25% drop forecast by directors at the interim juncture, prompted by a 29% dip in profits at the halfway point off a 3% rise in turnover. However, a marginal recovery in world sugar prices and relatively strong performance from the sugar division helped bolster second-half earnings.

However, the performance underlines the dependence of the group on its core sugar, starch and sweeteners businesses. The performance of the food division, which headlines Tongaat's interests in mushrooms, edible oil processing plants, cotton gins, maize and animal feed mills, dehydrated

BRENT VON MELVILLE

food stuffs and industrial and commercial catering, was described by directors as "satisfactory".

Sluggish performances were recorded from all other divisions. A Tongaat spokesman said the building materials division (represented by Corobrik) continued to be burdened by the slumping building industry.

He said Corobrik had mothballed 14 of its existing 41 plants over the past two years and was running at about 60% capacity. "The division is very well-poised for any recovery in the industry, and particularly in low cost-housing, however."

3 Sugar
 Tongaat's textile division was hit in the first half of the year from unrest conditions in Natal and continued to post mediocre returns which were blamed on the "high incidence of low-priced imports" in the industry. The division boasts one of the biggest integrated textile factories in the country in David Whiteheads.

Aluminium sales, through Hulett Aluminium (the largest manufacturer of semi-fabricated aluminium products in Africa) faltered as demand and export prices continued to drop.

Directors said that capex of R200m over the year would have little effect in the short term. Borrowings for the year rose R51,7m to R377m (R325,3m), pushing gearing to 19,3% from 17,9%. The interest bill moved up 17% to R105m (R89,6m).

Largely because of allowances on capital spending the tax rate was reduced to an effective 32% from 36%, to R68,8m (R102,9m)

At its current share price of R16 the results put Tongaat on a p/e of 8,4 times and a dividend yield of 4,6%, which compares favourably with the sector averages of 6,0 and 6,8% respectively.

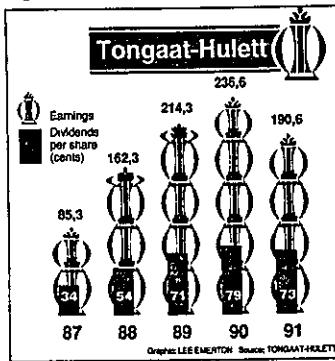

TONGAAT-HULETT Fm 24/5/91

STILL VOLATILE (3) Sugar

Tongaat-Hulett's diversification strategy is likely to come under renewed scrutiny from investors after the group's 19% drop in earnings for the year to end-March.

Chairman Chris Saunders warned in the last annual report that earnings this year were unlikely to exceed those achieved in

Continue →

Fm 24/5/91 (3) Sugar FOX

financial 1990. However, few shareholders could have expected EPS to have slumped 29% four months later at the interim. By then, management was forecasting a drop in annual earnings of 25%.

A strong second-half performance at Tongaat's sugar operations, bolstered by a good crop and some recovery in export prices, probably kept earnings from plunging that low — but the decline is sufficiently steep to cause investors to worry about the effectiveness of the group's spread of businesses.

Management has yet to release details of the profit contributions of the group's six divisions (these will presumably appear in the annual report), but it is clear that the strong earnings growth reported by the sugar and starch and sweetener operations fell far short of countering the profit slumps at the building materials, aluminium and textile

NOT SO SWEET

Year to March 31	1990	1991
Turnover (Rbn)	3,7	3,8
Pre-tax profit (Rm)	284,0	212,5
Attributable (Rm)	177,1	142,6
Earnings (c)	236,6	190,6
Dividends (c)	79	73

operations. Tongaat's other division, general foods, is unlikely to have made up much lost ground; according to management, it merely recorded satisfactory results.

Trading profit slipped 15% to R318m, on turnover that was almost static at R3,8bn — thus tightening operating margins from just over 10% to less than 8,5%. As a result of the group's capital expenditure programme (though the capex budget was cut by R50m it still totalled R200m) and reduced cash flow, borrowings climbed 16% to R377m, with gearing edging up to 19,3% (17,9%). Interest charges increased 17% to R105m.

While management says Tongaat is in the business of meeting man's basic needs for food, clothing and shelter, the composition of the group means it is far from immune to fluctuations in the economy. Management is looking to expand into more lucrative niches within the group's sphere of business. But there is little sign of any major departure into new areas that would give Tongaat greater stability of earnings.

The share has steadily improved since the beginning of the year. On these results, the counter, at 1 550c, giving a p/e of 8,1 and dividend yield of 4,7%, looks fully priced.

Simon Cashmore

Fm 7/6/91

SUGAR INDUSTRY ^{Fm 7/6/91} LIKE IT OR LUMP IT

When the SA Sugar Association (Sasa) announced this week that it was raising the industry price of sugar 13% on July 1, it patted itself on the back for keeping almost two points below the inflation rate.

But what a lot of people would like to know is why sugar on the international market today costs about R800/t, compared to the new domestic price of R1 396/t. The short answer is that the industry is sheltered by a sizeable amount of import protection. And, with the world price falling, Sasa is asking the Board of Trade & Industry for even more protection in case any imports attempt to sneak in. ^{③ Sugar}

The long answer is that sugar producers the world over are among the most protected members of the agricultural brotherhood. The result is a highly volatile world sugar price and an extremely distorted commodity.

To put the picture into perspective, Sasa's Glyn Taylor points out that only about 17% of the estimated 110 Mt of sugar produced

Fm 7/6/91 ③ Sugar

annually worldwide ends up on the world free market, making it in effect a residual or "dumping market" subject to sharp price fluctuations.

For example, the price of sugar per pound has fallen in just over a year from US16c to 7,5c as world production has overtaken consumption. This puts the current world price below the cost of production of even the most efficient producers.

But no one is rushing to get out of the business because almost all sugar producing countries are protected by one or more of a combination of preferential trade agreements, import quotas, tariff protection or subsidisation. The 17% of the total production that reaches the world market is the excess sugar that cannot be sold domestically or through trade agreements.

SA — because of international sanctions — sells all its export sugar at world market prices and no preferential markets are open to the local industry.

While SA consumers pay nearly double the current world price for their sugar, they remain better off than many consumers elsewhere. Sasa's Peter Nourse says the domestic price for sugar in the UK, supplied by the other EC and Commonwealth countries, is R2 780/t, double SA's price. The EC, the largest exporter of sugar, is protected by an import duty system.

Australia exports more than 2 Mt and has

a domestic price of R1 719/t — R323 more than SA, one of its main competitors. Australia, however, has preferential markets, including the US, a net importer of sugar.

America, in turn, has price protection based on a system that includes import permits and quotas, which has the effect of setting the import price at the same level as the domestic price. The cost to the sweet tooth? A domestic price about 300% higher than the world price.

Then-US agriculture secretary Clayton Yeutter summed up the problem in 1989. "We're not about to make major changes here in sugar policy until and unless other people make them as well. Sugar is one of the most severely distorted commodities in the entire world of international trade and we're among the distorters. But there are lots of other distorters as well. If we fix this matter, we have to fix it together with all the major sugar producers of the world."

So far, that hasn't happened. ■

Sugar industry releases figures

③ ~~Sugar~~

From DES PARKER

DURBAN. — The sugar industry has released its production figures for the first time in five years, indicating its reduced sensitivity to international trade restrictions.

The SA Sugar Association (Sasa) decided in October 1986 not to give out "sensitive statistical information about market conditions" when sanctions — particularly those imposed by the United States — began to turn international trade sour.

In the annual review of the 1990-91 milling season, presented at the congress of the SA Sugar Technologists Association in Durban yesterday, Sasa said the industry produced about 2 028 million tons of sugar.

This is well down from the record 2,54 million tons produced in calendar 1985.

According to the review, the "pronounced trend" towards better-quality cane since 1987-88 did not continue in the latest season. However, quality did compare well with levels for the past 10 seasons.

Geographical and climatic factors appeared to exert an "important influence", with the poorest cane being grown on the north coast.

ABC 11/6/91

Sugar veil lifted to show output drop

Own Correspondent

DURBAN — Sugar production figures were disclosed for the first time in five years at the SA Sugar Technologists' Association congress yesterday.

SA made 2 027 591 tons last season compared with the 1984/85 season's 2,3-million tons; Zimbabwe produced 464 619 tons; Swaziland 496 435 tons and Malawi 187 391 tons.

Difficult trading conditions, boycotts and sanctions persuaded the industry to keep its output secret until now.

Association president Peter Rein told the congress that SA had joined other world sugar producers to set up a biotechnical research programme aimed at producing cane that would resist diseases and improve yields. *3 sugar*

He said SA had lost its place as the lowest-cost producer of sugar, and that the challenges from the sweetener aspartame and from high fructose corn syrup and beet sugar were substantial.

Rein said that sugar cane yields had not continued to increase significantly in the past 20 years and "it appears we need to look for greater productivity".

Three in race to build sugar mill

SI Times (Bus Times)
16/6/91

3 Sugar 12/6

By IAN SMITH

THE GOVERNMENT is expected to decide before the end of the month which of three major groups wins the right to build a R300-million sugar refinery in the Eastern Transvaal.

The three are Barlow's CG Smith, Rembrandt's Transvaal Suiker Beperk (TSB) and Lonrho-backed Nkomati.

The SA Sugar Association sent bids from the groups to the Department of Trade and Industry, which has to approve any new mill.

Expansion

Time is pressing because if the decision does not come before the end of July the mill will miss out on a full season's crushing, say experts.

The successful bidder is likely to need at least three months to get the project going. Construction will take another 18 months to two years.

The project has attracted interest because the Eastern Transvaal has

good prospects for increased sugar production. Many small growers have joined the established TSB and major expansion is envisaged in KaNgwane.

CG Smith chairman Glyn Taylor says the area is attractive because of increasing urbanisation in Natal, timber encroachment on sugar land and the long distance of canelands from mills.

The mill, to be sited near Onderberg, will produce about 120 000 tons of sugar a year, a small part of SA's total output of 2-million tons last year. But it will account for nearly half of the industry's planned expansion.

The plant is considered to be of strategic value because it will add to SA's export surplus, currently about 35% of production. The domestic market is growing by about 4% a year.

The mill will be the first additional crushing plant to be commissioned since TSB's mill was built at Malelane in the Eastern Transvaal in 1965.

The last new mill, commissioned by

Tongaat-Hulett at Felixton in Northern Natal in 1984, replaced two old ones which were closed.

TSB, which started sugar production about 25 years ago, hopes that its close links with growers in the Eastern Transvaal will support its claim to the new mill.

The company has embarked on the second phase of a R22-million expansion programme. The increased capacity would enable TSB to crush the expanding crop from existing quota growers. It would also be able to handle cane being grown in anticipation of the mill.

Waste

TSB produces hardboard and animal feeds and is involved in promising trials with the Sugar Milling Research Institute and CSIR to produce a single-cell protein from bagasse, the waste fibre from cane, which will be suitable for animal feed.

The Department of Water Affairs plans to build a dam at Driekoppies to irrigate enough cane for a mill with a capacity of 150 000-tons a year.

Outlook for sugar producers improving

Star 27/6/91.

Finance Staff

3 Sugar

DURBAN — Prospects for the 1991/1992 sugar season are encouraging and an improvement in total sugar production of 10 percent is predicted, says Dick Ridgway, chairman of the Sugar Millers' Association.

Domestic sales reached a record high of slightly over 1,3 million tons in the review year and had recovered from their previous decline.

Mr Ridgway said: "This achievement is due mainly to economic incentives, promotional programmes, close liaison with all sectors of the market and improvements in distribution."

Prospects for the future domestic market seem promising, with the signing of a 10-year contract to supply Botswana.

Mr Ridgway was optimistic about the long-term prospects for the domestic market, and said market growth and consumption would increase when the

economy stabilised.

However, he said the immediate future would be difficult because of reduced consumer spending resulting from continuing inflation and unemployment.

The industry's loan indebtedness had been reduced to R87 million from R327 million in March 1986, despite the fall in world prices to 10 US cents/lb in August 1990.

Despite these depressed prices, the industry maintained stable export revenues throughout the year.

Expansion and deregulation measures over the past year had resulted in a significant increase in the number of small cane growers.

The considerable potential for expansion in this sector would nevertheless take some years to show.

Proposed expansion in sugar milling was expected to produce an additional 300 000 tons of sugar over a period of years and would create an estimated 12 000 jobs.

Sugar industry set for a more stable decade

3 Sugar
By Paul Ash
12/6/91

WHILE sugar prospects for the medium term were not as rosy as they were in the "sweet Seventies", this decade would see a more stable sugar industry after the depressed progress of the Eighties, SA Sugar Association (Sasa) chairman Glyn Taylor said on Friday.

Taylor's optimism came shortly after Sasa announced a 13% hike in the industry price of sugar from July 1.

This will raise the industry price of white sugar from R160 from R1 286 a ton to

R1 396 a ton and that of brown sugar R146 from R1 122 to R1 268 a ton.

Sasa says it has managed to keep the price of sugar below the inflation rate for the past five years.

In real terms, the price of sugar "is significantly lower" than it was in 1986, Taylor said.

Internationally, the sugar industry enjoyed a high degree of agricultural protection.

Taylor said local producers hoped for some relaxation of protection.

However, until steps

were taken by all countries concerned to ease protection measures, any change in the status quo was unlikely, he said.

A fluctuating world sugar price had added to the industry's woes.

In the meantime, Sasa had appealed to the Bureau of Trade and Industry for added protection.

Taylor said current protection might have been satisfactory at a world price of \$360 a ton, but a

lower price necessitated more protection.

Last week the sugar price dipped to \$180 a ton from a peak of \$357 a ton last season.

A sugar industry observer said Swaziland, protected by the Lome Convention and a substantial US quota, was an example of a protected producer.

Swazi sugar labourers reportedly earned wages equivalent to a third of those taken home by SA's sugar workers.

The absence in the market of China and the Soviet

Union, two major sugar importers, could have negative repercussions on the industry, he said.

Russia was experiencing political problems and China was faced with a surplus of production.

Sasa was optimistic that every ton of export sugar produced this season would be sold without any price sacrifice, despite a 10% rise in the crop estimate on last year's figures.

A good season would help Sasa reduce its R87m debt support loan to R57m, Taylor said.

Sugar price set to rise 13% next month

8 to am 4/6/71
THE price of sugar would rise 13% from July, the SA Sugar Association announced yesterday.

Chairman Glyn Taylor said the price increase was necessary in the light of the industry's increasing production costs.

SA was hampered by inflation of 14,8% and this, coupled with low growth rates, was creating adverse conditions for the sugar industry. The industry had tried to keep the price increase below the rate of inflation, Taylor said.

3 Sugar
PAUL ASH

The increase will boost the industry price of white sugar by R160 a ton from R1 236 to R1 396 and brown sugar by R146 a ton from R1 122 to R1 268.

Consumer prices of white sugar, which are determined by wholesalers and retailers, are expected to rise 45c a 2,5kg packet.

A Housewives' League spokesman said the average price for a 2,5kg packet of white sugar was currently R3,89.

World market for SA sugar likely to grow

28/6/91 *Bloom 28/6/91* *3-sugar*

TOKYO — Far East consumers may start to depend more on Thailand as a source of sugar as the lifting of economic sanctions against SA expands the world market for its sugar exports and diverts supplies from Asia, Tokyo traders said.

"I think Canada, Israel and Portugal, which have rejected SA origin sugar since the late 1980s, will start importing again," said trade house Toshoku Ltd MD Hiroyuki Minakawa, adding that that could lead to a decline in sugar supplies to the Far East.

"Asian consumers will have to depend on the Thailand origin more, raising its premium," he said.

Alternative

International Sugar Organisation (ISO) data shows that SA exported about 1,02-million tons of sugar to world markets in 1985 with 171 068 tons to Canada, 74 155 to Israel, 30 121 to Portugal and 67 021 to the US.

But trade curbs by Western nations, protesting against apartheid, whittled away SA's share of the world sugar market.

By 1989, major sugar importers, such as Canada, Israel, the US, Sri Lanka, Portugal and Mozambique, had stopped importing the commodity from SA.

Major sugar consumers in Asia like Japan and South Korea are searching for alternative suppliers and will consequently look to their neighbouring producer — Thailand.

"Australia, Cuba, Thailand and India have

been major sugar suppliers. But Australia is expected to cut some of its exports because it is suffering from a drought this year.

"India, which has had financial troubles, needs large subsidies to sell the commodity on the international market," a major trading house official said.

"Thailand is the most likely sugar source to replace the share of SA," the official said.

"It makes sense that sugar exports to these markets will resume. Given the lower freight rate, Europe and North America are attractive destinations for SA.

"It will diversify the destinations for its sugar exports and domestic sugar consumption is also increasing as living standards improve. That could make supply/demand conditions in the Far East tighter," he said.

Traders said the premium on Thailand origin against the spot New York price may climb to about 120 points later this year from around 20 in mid-1990, reflecting growing popularity among Asian consumers.

Trade house Toshoku estimates Japan's sugar imports in calendar 1991 as 637 000 tonnes from Thailand, 550 000 from Australia, 250 000 from SA and 200 000 from Cuba.

In calendar 1989, Japan imported 673 697 tons.

Thailand produced a record 40,6-million tons of sugar cane in the 1990/1991 cane crushing season against 33,6-million the year before and a previous annual high of 36,7-million in 1988/89, the industry ministry said. — Reuter.

Children, cane growers benefit

IDT millions for range of new projects

B/Dary 11/7/91

3 Sugar
[scribbles]

CAPE TOWN — The Independent Development Trust (IDT) has allocated millions of rands for a range of new development projects which will reach 1,2-million pre-school children, 15 000 small sugar producers and thousands of underprivileged South Africans.

The trust has also initiated new development strategies and agencies, combining forces with the Urban Foundation, other organisations and private investors, to co-ordinate massive childcare and housing projects which have benefited from the R1,5bn it has allocated since last August.

In a campaign to reach at least 1,2-million of the estimated 3,5-million impoverished young children in SA, IDT trustees have voted R70m to upgrade and expand pre-school facilities around the country.

To sustain this campaign, the IDT has laid the foundations for a national strategy, agreed on by a wide range of organisations, to ensure the effective use of its funds and the mobilisation of additional funds for pre-school care. The strategy will be implemented by the elected national body, and government and the private sector will be approached to take over the funding responsibility.

The IDT also has allocated R17,5m to capitalise a non-profit development agency which will use the combined resources

LESLEY LAMBERT

of the IDT, the Urban Foundation and private sector investors to provide bulk quantities of serviced sites.

In practice, the operations of the Urban Foundation's housing utility companies will be consolidated in a single entity which will provide serviced sites and technical, financial and back-up services to communities and other low-cost housing developers.

In another significant development, the IDT has approved in principle an initial R42m loan to finance 15 000 small sugar cane producers over the next few years.

The funds will be channelled through the SA Sugar Association (SASA) and used to finance the first three years of a five-year development programme involving more than 45 000ha of sugar cane in Natal/Kwa-Zulu, KaNgwane and the Transkei. Subject to annual reviews of the project, the IDT will advance a further R25m in the remaining two years.

The IDT's investment in the small sugar farming sector is part of a project in which SASA's Small Sugar Cane Growers' Financial Aid Fund has advanced R53m in loans to small growers since 1973. This has increased the number of sugar farmers who would otherwise not have had access to

To Page 2

IDT

3 Sugar

From Page 1

agricultural land from 4 000 to 33 000.

Other organisations such as the Development Bank of Southern Africa, the Kwa-Zulu Finance Corporation (KFC), the sugar mills and the private sector will become major participants in the project.

The Development Bank has already started investigating infrastructure such as roads, mechanisation services, haulage, land preparation and the supply of equipment for small irrigation schemes. It will also raise finance for the project, channeling it through the KFC, while SASA and the sugar mills will provide training in cane farming methods and administration.

Other allocations include:

□ R2,5m to the Valley Trust for the construction and equipping of a health care centre in Natal and the completion of five health subcentres in the area;

□ A R270 500 grant to the Elim Care Group movement in the northern Transvaal to fund efforts by voluntary community health workers to immunise children against disease, improve sanitation and chlorinate water; and

□ R189 000 for the purchase of a site in Mitchells Plain on which a senior care complex will be built.

B/Dary 11/7/91

BUSINESS

Shortage pushes up sugar price

star 12/17/91 (3) sugar

LONDON — Tight supplies in the Far East have pushed up world sugar prices from a three-year low to a six-month high in the last few months.

Yesterday sugar was quoted on the London market at \$177.00 a metric ton against \$130.00 in April, a rise of more than 30 percent.

But London-based sugar trader C Czarnikow warned yesterday that sugar prices could fall because of good new season production prospects.

Production problems in Australia and Cuba — two of the main suppliers to Japan, South Korea, China and the Far East's other big buyers — are behind the current tight supply position, said a Czarnikow report on the market.

Bad weather combined with a shortage of fuel and spare parts, because of lower deliveries from the Soviet Union, have hit Cuba's harvest, said Chris Pack, Czarnikow's senior analyst.

Official figures put Cuban production at 7.62 million tons, down 500 000 tons from last season.

Drought cut this season's Australian harvest, with total 1990-91 (August-September) sugar exports estimated by FO Licht, the German sugar research company, at 2.48 million tons, compared with 3.18 million in 1989-90.

But the supply position in the Far East would have been worse, traders said, without the good harvests in India and Thailand, the region's other main suppliers.

Czarnikow said that

Thai output of about 4.04 million tons was expected this season, which would be the second biggest crop on record.

Licht estimates India's 1990-91 harvest at 12.84 million tons, up from 11.95 million tons last season. But Licht said Indian exports were being hampered because prices asked were uncompetitively high.

Despite the setbacks in Cuba and Australia, more sugar will be produced in 1990-91 (September-August) than consumed and new season production prospects — helped by timely rains

in Western Europe and the Far East — are looking good, the London-based commodity trader ED and F Man Ltd. said.

Man estimates that world production of the sweetener in the 1990-91 season will exceed consumption by 4.2 million tons, which would be the second season running with a surplus.

Most traders predict that 1991-92 will make it three consecutive seasons of overproduction, pushing up surplus stocks from the exceptionally low level reached in 1988-89 after several years of deficit.

— Sapa-AP.

By IAN SMITH

DURBAN is set to capture all of Southern Africa's sugar export trade.

The sugar-handling terminal which loads SA exports of about 900 000 tons a year has displaced Maputo as the exit port for Swaziland's crop in the season, which began on April 1.

All of Swaziland's 350 000-ton crop is being moved through Durban this season. Zimbabwe is also considering a switch.

Zimbabwe's sugar exports have been severely hit by water shortages, but foreign sales are expected to total 140 000 tons this year.

The loss of this trade would be a big blow to Maputo's sugar terminal which was designed to handle 700 000 tons a year. It was rehabilitated with foreign aid after Zimbabwe's independence to replace Swaziland's and Zimbabwe's reliance on SA ports.

The problem with the Maputo route is theft, says Zimbabwe's Beira Corridor Group, a private-sector organisation established to encourage the use of Mozambique ports.

Sabotage

It says Swaziland and Zimbabwe lost 6,4% of their sugar shipments through Maputo last year through theft and pilferage. More than 17 500 tons worth R10,2-million went missing.

Trainloads have been lost after sabotage on the Zimbabwe-Maputo rail link and truckloads have disappeared at Maputo.

SA Sugar Association international marketing director David Hardy, confirms that Swaziland producers are moving all their exports through Durban.

Durban gets all sugar exports

SI Times (Durban) (Wed)
14/7/91
③ Sugar

The terminal, which is up to world standards, has three bulk silos capable of holding 520 000 tons of sugar. A new R13-million bagged-sugar warehouse is due to be opened this week.

"All export shipments are moving smoothly," says Mr Hardy.

In previous years Swaziland sent 400 000 tons of sugar to Maputo. Zimbabwe shipped up to 200 000 tons of sugar through it. Last season Swaziland cut shipments through Mozambique to 143 000 tons. Zimbabwe's exports were cut by lower harvests to 131 000 tons.

The switch to Durban has serious implications for Zimbabwe's direct rail link with Maputo. It passes through the sugar production area in Zimbabwe's south-eastern Lowveld.

Its viability will be threatened without sugar traffic. Costs at the Maputo terminal will also increase without the Swaziland crop.

The Beira Corridor Group says: "The line's fate, in essence, depends on how Zimbabwe assesses Maputo's ability to implement a strategy which ensures that its sugar crop is handled efficiently and without loss.

"If this cannot be achieved, South Africa's ports and railways can reasonably expect a bonus."

Philippines in bitter-sweet

war with SA
Star 18/7/91
By Hugh Robertson
Star Bureau

WASHINGTON — They call it the "sugar war" or, more formally, the South African-Philippines conflict of interest, but either way it is a nettlesome dispute for the United States to resolve in the wake of President George Bush's decision to lift sanctions.

It centres on the conflicting claims of the South African and Philippines governments over who should retain a sugar quota of 50 000 metric tons that used to belong to South Africa but was switched to the Philippines in 1986 when sanctions were imposed.

It is one of the issues now on the agenda of negotiations between South African and US government departments aimed at normalising relations.

From the South African perspective, the claim to the quota seems entirely just and reasonable. It used to belong to South Africa, and now that South Africa has expunged those reasons for the withdrawal of the quota, it should revert to South Africa.

The Philippines is the only true "colony" the US has possessed and has a special place in the hearts and minds of Americans.

The Philippines government is putting up a spirited battle to hold on to the sugar quota. Its most persuasive argument is that the quota represents the livelihood of 15 000 workers.

US hesitant over sugar quota

18/7/91
SIMON BARBER

WASHINGTON — The Bush administration is "dragging its feet" over giving SA back its US sugar import quota, the SA Sugar Association's (Sasa) Washington lobbyist Mark Ginsberg said yesterday.

If the quota is not restored by the end of September, SA growers stand to lose \$4m in lost trade, he said.

The State Department and the US Trade Representative's office (USTR) have agreed in principle that President George Bush's executive order rescinding the Comprehensive Anti-Apartheid Act's (CAAA) sanctions should have immediately restored SA's quota to 1986 levels.

However, the CAAA specifically transferred SA's quota — 2.3% of total US imports — to the Philippines, with which the administration is currently concluding

delicate negotiations over the renewal of leases for US military bases.

Washington fears that an announcement that the Philippines was losing its quota could seriously complicate the talks.

Ginsburg says the USTR intends to reduce worldwide sugar imports to the US on October 1, the start of the 1992 fiscal year. This will effectively devalue SA's quota.

Sasa is therefore anxious that SA growers should get the full benefit of current limits. The balance of SA's 1991 quota was 12-million tons worth \$4m, Ginsberg said.

It is understood that KwaZulu Chief Minister Mangosuthu Buthelezi may be asked to contact Bush directly to plead on behalf

□ To Page 2

Sugar

of Natal growers.

Other technical questions left in the wake of the repealed CAAA sanctions are being resolved more quickly.

Following talks between the State Department and SA embassy personnel on Tuesday, the administration is adopting "expedited procedures" that will enable SAA to resume US flights while a new air services agreement is worked out.

The administration has suggested that SAA might consider landing at Washington's Dulles Airport — to begin with, at any rate — because Dulles is federal property. Government would therefore be able to

prevent the kind of protests and labour disruptions that may occur in New York.

The Rangel Amendment's double taxation requirement is no longer in effect, but there is felt to be no hurry to restore the bilateral tax treaty which was cancelled by the CAAA.

The treaty, the renewal of which would be subject to Senate ratification, defined which indirect taxes paid in SA US companies could count as credits against their US taxes.

Air shipments of SA wine, cut flowers and textiles are expected to start arriving in the US very soon, a US official said.

□ From Page 1

Philippines in bitter-sweet ^{sugar}

war with SA

Star 18/7/91
By Hugh Robertson
Star Bureau

WASHINGTON — They call it the "sugar war" or, more formally, the South African-Philippines conflict of interest, but either way it is a nettlesome dispute for the United States to resolve in the wake of President George Bush's decision to lift sanctions.

It centres on the conflicting claims of the South African and Philippines governments over who should retain a sugar quota of 50 000 metric tons that used to belong to South Africa but was switched to the Philippines in 1986 when sanctions were imposed.

It is one of the issues now on the agenda of negotiations between South African and US government departments aimed at normalising relations.

From the South African perspective, the claim to the quota seems entirely just and reasonable. It used to belong to South Africa, and now that South Africa has expunged those reasons for the withdrawal of the quota, it should revert to South Africa.

The Philippines is the only true "colony" the US has possessed and has a special place in the hearts and minds of Americans.

The Philippines government is putting up a spirited battle to hold on to the sugar quota. Its most persuasive argument is that the quota represents the livelihood of 15 000 workers.

FM 19/7/91

SUGAR INDUSTRY

(3) Sugar

NAIL-BITING TIME

The sugar industry, eager to hear who will get the contract for a new R300m mill in the Onderberg region of the eastern Transvaal, fears that if a Cabinet decision is not made by the end of the month, a season's crushing could be lost.

Growers are concerned too. It will probably take at least two years to get the proposed mill up and running. And any further delays from government will affect the calculations of the big growers on how much cane to plant and keep small growers from KaNgwane out of the industry for another year.

On top of this, the costs of the mill are escalating by an estimated R3m a month. "If the mill is going to come, it must come now; it's getting more expensive by the day," says Jan Lourens, a Komatipoort grower and former part-owner of the Ntumeni mill. "Growers here are very disappointed that a decision has not yet been taken."

The new mill is integral to the industry's expansion and deregulation programme and once built, it should account for an additional 130 000 t of sugar a year. The increased production will ultimately allow thousands of new, small, mainly black growers into the industry. The hold-up is that government must approve the mill, a throwback to the days of more restrictive sugar regulation.

Three companies are bidding for the mill — Barlow Rand's C G Smith Sugar, Rembrandt's Transvaal Suiker Beperk (TSB), and Nkomati, backed by London-based Lonrho. The SA Sugar Association forwarded the proposals to the Department of Trade & Industry in February and expected a decision by mid-year. But the change in Ministers in April has delayed the process.

The department now has forwarded its recommendations to the Cabinet and a decision could come when Cabinet sits on July 25. It is not known, however, whether the proposed mill is on the agenda for that meeting and the announcement could be postponed until next month.

All three contenders for the mill believe they have a fair shot, though a strong feeling is emerging from eastern Transvaal growers in favour of C G Smith, which accounts for 37,5% of SA's total production of just over 2 Mt a year. Says Lourens: "It is unlikely the new mill will be economically viable for about the first five years and you need a big company to carry that cost."

Also working in C G Smith's favour are the benefits offered to growers in its bid, including a proposed scheme to allow farmers 25% equity in the mill and a financing plan for the proposed storage dam.

A strong argument in favour of TSB is that government might favour a smaller company to promote more competition. The newcomer to the industry produced 212 000 t of sugar last year, just over 10% of total production. Government may also con-

ADVERTISING COLUMN

The FM's advertising and marketing columnist, Tony Koenderman, is in the Far East. His column resumes next week.

FM 19/7/91 (3) Sugar
sider that TSB's existing mill at nearby Malelane could mean easier rationalisation.

But that, in turn, doesn't please many eastern Transvaal growers. They fear that if TSB gets the contract it might run the new mill from Malelane, without bringing significant new facilities to Onderberg. C G Smith, they argue, has already indicated it would run an autonomous operation with its own staff and facilities.

It is also being argued that while TSB is small in the national sugar market, the new mill could give it the clout of a regional monopoly in the eastern Transvaal.

In Natal, C G Smith is balanced out by Tongaat-Hulett Sugar, the industry's biggest producer, accounting for about 42% of total production. Tongaat-Hulett decided not to bid for the new mill.

And while Lonrho-backed Nkomati, formed by miller Jan Henn, has not featured as prominently in the race, it could win if government seizes the opportunity of attracting the overseas funds of the London-based conglomerate that has sugar interests in Kenya, Uganda, Malawi and Swaziland. ■

Sugar quota quandary^{Star} 19/7/91 as US drops sanctions

By Hugh Robertson ^{(3) sugar}
Star Bureau

WASHINGTON — They call it the "sugar war" or, more formally, the South African-Philippines conflict of interest.

It is a nettlesome dispute for the US to resolve in the wake of President George Bush's decision to lift sanctions.

It centres on the conflicting claims of the South African and Filipino governments over who should retain a sugar quota of 50 000 tons that used to belong to South Africa but was switched to the Philippines in 1986 when sanctions were imposed.

It is now on the agenda of US-SA negotiations aimed at normalising relations.

From the South African perspective, the claim to the quota seems entirely just and reasonable. It used to belong to South Africa, and now that South Africa has expunged those reasons for the withdrawal of the quota, it should revert to South Africa.

The Philippines is the only true "colony" the US has possessed and has a special place in the hearts of Americans.

The Filipino government is putting up a spirited battle to hold on to the quota. It argues that it represents the livelihood of 15 000 workers.

Who should Washington support? The favoured child born of American expansionism in Asia, or the prodigal son who has realised the evil of his ways?

Is there a middle course? Could the US expand its sugar quota to include both rivals? Probably not.

SA could sell double volume of sugar to meet overseas demand

By David Canning *SAW 24/7/91*

DURBAN — South Africa is experiencing such high foreign demand for sugar that it could easily sell twice the volume of its exports if sufficient supplies were available, industry executives said here.

They were speaking at the opening of a bagged sugar warehouse and at the annual meeting yesterday of the SA Sugar Association (SASA).

John Chance, vice-chairman of SASA, said throughout the sanctions years SA had found ready markets and had never had to discount its sugar.

More recently SASA had been inundated with inquiries.

The quality of SA sugar, and the reliability of deliveries, were among the main reasons for interest from the older traditional customers as well as potential new buyers.

Chairman Glyn Taylor said at the opening of the R13,5 million bagged sugar complex at Maydon Wharf that the new facility

would give SASA greater flexibility to spread its exports over a wider field, complementing the three neighbouring giant silos.

The warehouse also had made it easier to handle exports of Swazi sugar through Durban.

Great value

"The undertaking is overall one of the biggest of its kind in the world and it will be a continuing success for the sugar industry in SA.

"The terminals have also proved to be of great value to our neighbouring countries.

The three existing silos have a combined capacity of 520 000 tons of bulk sugar and the current replacement cost is over R150 million. The new warehouse has capacity to store 57 000 tons of bagged sugar.

It is estimated that since 1965, a total of 20,9 million tons of sugar have been loaded on to 1 690 ships with an average shipload of 12 400 tons.

Cosatu congress to make vital choices

VERA VON LIERE ~~6/12/91~~ 25/11/91

COSATU's relationship with the ANC and SACP will be scrutinised by more than 2 500 delegates to the federation's fourth national congress which starts at the Nasrec show-grounds near Johannesburg today.

The conference will be attended by delegates from 14 affiliated unions.

The ANC, SA Communist Party, PAC, SA Council of Churches and the SA Catholic Bishops' Conference have been invited, as have guests from trade unions and labour federations around the world.

A key issue on the agenda will be the adoption of a workers' charter, to ensure that a future constitution will entrench workers' rights and guarantee trade union independence. Such a charter would include the right to strike, organise, belong to a union and the right to a democratic government.

Congress delegates would consider whether Cosatu should play a direct role in the negotiation process, Cosatu general secretary Jay Naidoo told a news briefing last week.

Cosatu's tripartite alliance with the ANC and SA Communist Party will also come under scrutiny, Naidoo said discussions would be aimed at strengthening the alliance.

Delegates will discuss how the issue of overlapping union and political leadership in the alliance can be regulated to ensure that it does not compromise the federation's independence. ~~6/12/91~~ 25/11/91

Delegates are likely to support a broader strategy for peace and will discuss self-defence. They will also focus on adopting an economic policy with the emphasis on a union role in economic and industrial planning to create jobs and meet basic social needs.

'Sugar sector outlook strong in long term'

6/12/91 25/11/91

Own Correspondent

DURBAN — The long-term sugar market could be viewed optimistically, outgoing chairman of the SA Sugar Association, Glyn Taylor, said at the annual meeting yesterday.

Making a forecast for the short term he said a modest improvement was expected in domestic market sales following last year's exceptionally high growth. The sales estimate figure was 1,329-million tons of which 88% would be white sugar.

The proceeds would be boosted by the recent price rise but the increase had to be measured against sharply escalating production costs due to high inflation.

The export market had seen prices slumping from \$357 a ton just over a year ago to \$200 a ton for deliveries in December this year.

World production had surpassed consumption two years in a row while some countries had cut purchases due to recession and foreign exchange shortages. Export proceeds for farmers would not be "very remunerative".

But the premium on the export market for white sugar "has been remarkably strong at over \$100 a ton and a good premium seems set to continue".

This appeared to present an opportunity for SA, which was examining the feasibility of further increasing refining and conditioning capacity. A back-end plant attached to a sugar mill would require investment of about R75m.

The past 40 years had seen a steady 2% growth in world consumption which by the year 2000 would reach 131-million tons — a rise of

21-million tons. That annual rise was equal to SA's total annual output.

Taylor said most production would be consumed where it was grown but a "significant quantity will be left for the world market".

"At the current depressed price levels nobody is going to invest capital for additional world market sugars and this should have the price trending upwards in the medium to longer term.

"I remain optimistic that the 1990s will be altogether better years for SA sugar and sugar cane producers than the 1980s," Taylor said.

Sanctions

Discussing the reasons for the differential between the domestic price of sugar and the world price Taylor said the world price represented a "dumped price".

SA sold all its sugar into this market and it had no preferential arrangements — SA enjoyed a US quota which represented a price premium on the 10 000 to 20 000 tons sold there, but this fell away under sanctions. Dropping of US embargoes could revive that market.

On escalating food prices Taylor said the industry sugar price was now, in real terms, lower than it was five years ago — the aggregate rise in sugar prices was below the rise in the food and consumer prices indices.

He said that keeping these price rises down was made very difficult by steeply rising costs of all agricultural and factory inputs.

Taiwan's development plans hold promise for SA

LINDA ENSOR



CAPE TOWN — The Taiwanese government's plans to spend about \$2bn on capital projects to develop Taiwan's economic infrastructure during the next six years has huge potential for SA construction and engineering companies.

SA trade councillor in Taipei Stephan Pretorius yesterday told the Cape Town Chamber of Commerce SA companies had successfully tendered for large capital projects in the past.

There were orders, for example, for trains, rails, asphalt plants and locomotives as Taiwan upgraded its transport system.

Pretorius said the fast-growing Taiwanese economy had outgrown its infrastructure.

The country was not self-sufficient in terms of expertise and skilled labour, and would have to look abroad for assistance.

Taiwanese figures show that trade between Taiwan and SA amounts to about \$2bn annually. SA exports concentrate on coal, steel and iron ore. Steel exports total about \$300m, and 25% to 30% of Taiwan's coal requirements come from SA.

Pretorius said Taiwanese exports to SA tended to be consumer products. Government and industry were working together to export more value-added goods, such as supermarket products.

SA fruit juices and beer had been very successful. Ceres exported 55% of its fruit juice production to Taiwan, while 300 000 cases of Castle beer had been sold there this year.

Pretorius said it was possible that Castle, now fifth in the beer ranks, could take the top slot next year. SA biscuits were also sold.

He said he had received many inquiries from SA motor manufacturers about export of components to Taiwan, which had restricted Japanese imports because of that country's large trade surplus with Taiwan.

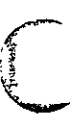

③-sugar

SA declares sugar war with Phillipines

US in awkward position over quota dispute

HUGH ROBERTON, The Argus Foreign Service

WASHINGTON. — They call it the "sugar war" or, more formally, the South African- Phillipines Conflict of Interest, but either way it is a nettlesome dispute for the United States to resolve in the wake of President Bush's decision to lift sanctions.

It centres on the conflicting claims of the South African government and the Phillipines government over who should retain a sugar quota of 50 000 metric tons which used to belong to South Africa, but which was switched to the Phillipines in 1986 when sanctions were introduced.

And it is one of the issues now on the agenda of negotiations between the South African government and an array of US government departments aimed at normalising South Africa's relations with the US in many different fields.

From the South African perspective, the claim to the quota seems entirely just and reasonable. It used to belong to South Africa, and now that South Africa has expunged those reasons for the withdrawal of the quota, it should revert to South Africa.

Except, of course, the discomforting fact that justice and reasonableness comprise but a small rebuttal to history and political expediency

The Phillipines is the only

true "colony" which the US has possessed, and the country has a special place in the hearts and minds of the US public and US policymakers. Occasionally it is called the "phantom 51st state", more cynically "our obligation in Asia."

Either way, the Phillipines government is putting up a spirited battle to hold on to the sugar quota, and yesterday the country's Secretary for Trade, Mr Peter Garrucho, sent a polite letter to Washington giving the reasons why Manila should retain the 1986 bonanza.

The most persuasive reason - certainly one which is likely to wield a lot of clout in all the power points in Washington - is the fact that although the quota is only worth between \$12-million and \$15-million a year, it represents the livelihood of 15 000 workers.

Not just ordinary workers, but workers principally on the island of Negros, where a Communist-led insurgency has presented the most formidable and consistent challenge to the government of President Corazon Aquino in Manila. Lately the insurgency has shown signs of abating, but the loss of the "South African" sugar quota would be a devastating reversal.

The South African quota now represents about 15 percent of the total sugar exports of the Phillipines, and the argument which tacitly is being presented by Manila is that South Africa cannot escape the consequences of its past mistakes,

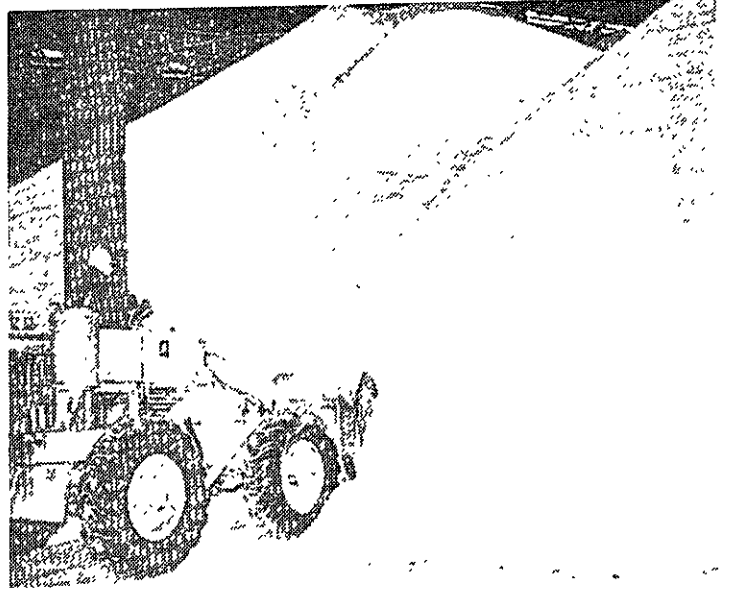

SUGAR MOUNTAIN: Will the US restore SA's export quota of 50 000 metric tons presently granted to the Phillipines?

and that it would be unreasonable to make 15 000 workers in the Phillipines pay the price of bringing wisdom to Pretoria.

On the other hand, according to US sources, Pretoria's argument that it is entitled to a priority claim on those trade agreements and advantages which it secured over many years of competition is "very solid and persuasive."

Who should Washington support, the favoured child born of American expansionism in Asia, or the prodigal son who recently has come to realise the evil of his ways?

Is there a middle course,

whereby the US could simply expand its sugar quota to include both rivals? Probably not. The US itself is a major sugar producer, with influential forces in Louisiana, Texas Florida and Hawaii watching with avaricious interest the "sugar war" now underway in Washington.

A source in the Louisiana delegation to Congress remarked: "It's hard to explain to working people that we are a superpower and that we have foreign obligations and interests. We're going through a recession, and it is hurting. What's the big deal that your country is coming up with?"

Demand for refined sugar sets industry on new tack

DURBAN — The sugar industry is considering increasing its refined output to take advantage of higher world demand for white sugar, says Glyn Taylor, chairman of the Sugar Association.

He told the association's AGM that SA was traditionally an exporter of raw sugar.

However, in response to improved world prices for refined sugar, the industry was introducing white sugar into its export programmes. In 1989/90 white sugar exports peaked at 205 000 tons.

More recently, the white sugar premium has been remarkably strong at over \$100 a ton and a

good premium seems set to continue.

"As this would be a profit opportunity for the industry, we are busy examining the feasibility of increasing our refining and conditioning capacity still further."

Outturn

He said that overall it had been a good year for exports.

The industry had sold its full export outturn at remunerative prices, despite continued sanctions.

It was worth noting that in the past three years, the industry had earned close to R1,7 billion in foreign exchange, due mainly to

keen demand for sugar overseas.

Mr Taylor reported a serious drop in the world price of raw sugar from \$357 a ton just over a year ago to \$200 a ton for December 1991 deliveries.

This was mainly due to global production outstripping consumption for the second consecutive year with a concomitant rise in stocks.

"With the drop in price, export proceeds will fall well short of the levels enjoyed in recent years and this, in turn, means the B pool prices of sugar and sugar cane will not be every remunerative for producers," he said. — Sapa.

(Business Times)

TSB gets right to build sugar mill

By IAN SMITH

REMBRANDT's Transvaal Suiker Beperk (TSB) has won the right to build a R300-million sugar mill in the Eastern Transvaal.

The project will give a big boost to the economy of the region, and open the way for many small-scale growers in KaNgwane to enter the industry.

The announcement has come in time to allow final planning for the mill to go ahead this year. It could save a season's production being lost. (SITimes)

But decisions on the site of the mill and when construction will begin will be delayed until there is certainty about the supply of water from Drieskoppies dam, which has still to be built. (S) Sugar

Deputy Trade, Industry and Tourism Minister David de V Graaff says an expensive mill could not be justified if there were a shortage of water for cane growers. 28/7/91

"There must be proper co-ordination on the building of the mill and the availability of irrigation water from Drieskoppies dam."

The mill site, expected to be near Onderberg, will be

□ To Page 3

(SITimes)

Sugar mill

(Business Times)
□ From Page 1
28/7/91

chosen to minimise cane transport costs.

Temporary measures to process cane from growers who already have water will be discussed with the SA Sugar Association and TSB, says Mr Graaff.

Two other big sugar producers, Barlow's C G Smith Sugar and Lonrho's Nkomati Sugar Milling, submitted bids to build the mill, the first new one in SA since TSM's was completed at Malelane in 1965.

The mill is expected to produce about 120 000 tons a year, a small part of SA's production of 2-million tons last year. (S) Sugar

But it should account for about half the sugar industry's planned expansion. It will add to the exportable surplus, currently about 35% of output.

This is considered strategically important because the industry is looking for new foreign markets as sanctions are lifted.

TSB, which started producing sugar about 25 years ago, has started the second phase of a R22-million expansion programme.

It is designed to enable it to crush bigger crops from existing growers' enlarged quotas and to handle cane being grown in anticipation of the new mill.

Sweet end to 'sugar war' over SA quota

Star 30/7/91

By Hugh Robertson
Star Bureau

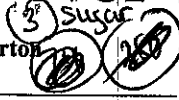

WASHINGTON — South Africa has regained its quota for exporting sugar to the United States after negotiations with US officials and is expected to begin shipping its first consignment soon.

The quota was confiscated in 1986 when sanctions were imposed and was transferred to the Philippines, which has put up a spirited battle to retain the annual 50 000 metric ton export bonanza.

US officials say the quota will revert to South Africa with effect from October 1, which

means that ships bearing sugar from South African ports will be entitled to offload in US harbours from that date. Loading is expected to commence in Durban before the end of August.

After lengthy argument between South Africa and the Philippines — the so-called "sugar war" — US government lawyers concluded that the granting of the quota to the Philippines was a temporary measure and that under international law it had to be returned to South Africa upon the cessation of sanctions.

Loss of the quota will be a damaging blow to the Philippines.

SA regains US sugar-exporting quota

The Argus Foreign Service

3 Sugar

at 50 000 metric-ton export bonanza.

WASHINGTON. — South Africa has regained its quota for exporting sugar to the United States following days of negotiations with US officials — and is expected to begin shipping its first consignment soon.

The quota was withdrawn in 1986 when sanctions were imposed and was transferred to the Philippines, which has put up a spirited battle to retain the annu-

US officials say the quota will revert to South Africa with effect from October 1, which means that ships bearing sugar from South African ports will be entitled to offload in US harbours from that date.

Loading is expected to begin in Durban before the end of August.

After lengthy argument between South Africa and the Philippines — the so-called "sugar

war" — US government lawyers concluded that the granting of the quota to the Philippines was a temporary measure and that under international law it had to be returned to South Africa when sanctions ended.

Lawyers acting for the Philippines challenged this view, pointing out that there was no indication in any documentation covering its diversion to the Philippines to suggest that it was not permanent. — Sapa-Reuter.

Return of US quota delights sugar industry

Star 31/7/91

3 SUSON

By David Canning

Sugar executives yesterday welcomed news that the US has restored South Africa's sugar quota for the financial year starting on October 1.

SA Sugar Association export manager David Hardy confirmed in Durban that the US had decided to give SA back its annual stake, amounting to 2.3 percent of the total US quota.

"We are very pleased the wheel has turned the full circle and will definitely be taking up the quota," Mr Hardy said.

The amount of the quota for the coming US year has not been announced. For the current year the total US import quota is about 2.1 million tons.

It was estimated some time ago that SA's share of this — if it had received a quota in the current year — would have been about 48 000 tons.

The most attractive aspect of the US quota is that the US price (now around 21 US cents a pound — which is the CIF duty-paid price) is more than double the world spot price of around 9.3 cents.

Star 11/8/91

Row flares over sugar mill

By Des Parker (3) Sugar

DURBAN.— Differences have surfaced in the sugar industry over the award by the Government to Rembrandt's Transvaal Sugar Corporation (TSB) last week of the right to construct a R300 million, 130 ton-a-year sugar mill in the Eastern Transvaal.

Johnny Henn, MD of Nkomati Sugar Milling of Eshowe — one of three companies which put in a bid to build the mill — claimed yesterday the Government wanted the Sugar Association to subsidise new and existing growers supplying cane to TSB's existing mill at Malelane until the new mill was on stream, which he said could take five years.

He maintained subsidies to growers flew in the face of sugar industry regulations precluding subsidisation of growers by mill-

ers — as well as Government deregulation policy.

He said while both his bid, which was backed by Lonrho, and that of Barlow Rand's CG Smith Sugar (CGSS) were made with no conditional interim assistance from the industry, TSB — which already owns the Malelane mill — would benefit greatly from subsidies paid to new and existing growers.

Mr Henn said: "I had Lonrho with R300 million ready to bring into the country to start construction of a mill right away. CG Smith was prepared to start building immediately; there was no talk of subsidisation or delays."

He claimed the Government was inconsistent, withdrawing subsidies on basic foods, while proposing to apply them in favour of big business.

SUGAR MILL CONTRACT AWARDED

FM 2/8/91

3
sugar

The good news for cane growers in the eastern Transvaal is that the Cabinet has finally awarded the contract for a new sugar mill in the region. When and where it will go up, however, has yet to be decided.

Rembrandt's Transvaal Suiker Beperk (TSB) last week beat Barlow Rand's C G Smith and Lonrho-backed Nkomati for the contract to build the mill, which is expected to produce an additional 130 000 t of sugar, most of which will be targeted for export (*FM* July 19).

The announcement coincides with the move by the US to reinstate SA's sugar quota, stopped five years ago under sanctions legislation. Exports to the US, which can resume on October 1, should account for about 50 000 t. But more important is that the current US price for sugar — about US21c/lb — is now more than double the world spot price.

In announcing TSB's award, the Department of Trade & Industry made it

clear that the start of construction on the estimated R300m mill was closely tied to the development of a new irrigation dam at Driekoppies, close to the Swaziland border.

Answers to the when-and-where questions will depend on discussions between the Department of Water Affairs, TSB and other groups, which could take some time. Some members of the industry believe that even if construction of the dam begins next year, it could be 1997 before the full benefit of the additional irrigation is realised. It is unlikely that TSB will wait that long before commencing with the mill, but it should take at least two years to build and possibly three years before it is fully operational.

The new mill will be a significant boost for TSB, which already operates a mill at Malelane and has embarked on a R22m expansion programme. The company produced 212 000 t of sugar last season, just over 10% of SA's total production.

Sugar regulations to remain in place

GOVERNMENT legislation controlling the marketing and production of sugar is to be retained, says the Department of Trade and Industry.

DTI spokesman Charl Nel said the Sugar Industry Agreement — legislation enabling the SA Sugar Association (Sasa) to regulate prices and supply — was being amended, but Sasa's "A- and B-pool" production and pricing system would not be affected. *Blom 12/8/91*

With sugar production and marketing being regulated worldwide, he said, SA could not act in isolation by dismantling controls overnight without "serious harm" being done to the industry.

Sasa sets the "A-pool" to meet domestic and export demand and then shares the quota between cane growers and gives

ROBERT LAING

them a fixed price each month. Excess ("B-pool") sugar is sold at international spot prices. *(3) Sugar*

Nel said: "Production in the A-pool consists of 1,3-million tons for the domestic market while the balance of 500 000 tons is exported at ruling world market prices, which are extremely volatile."

He said the deregulation measures taken by government in 1989 entailed lifting import control on sugar and molasses, allowing the industry (represented by Sasa) to set its own prices, relaxed administration and created "free production areas".

The last measure allows smaller growers living within 30km of a sugar refinery to sell their produce at A-pool prices.

Star 23/8/91
**World sugar
production
likely to fall**

London Bureau (3) Sugar

World sugar production is set to fall below consumption for the 1991-92 season following this season's large surplus, says the latest sugar review from Czarnikow, the London broker.

In its first estimates for next season, Czarnikow puts production at 113 million tons, down from 113.72 million tons for 1990-91.

Consumption, however, is predicted to rise sharply to 113.14 million tons from 110.94 million tons this year.

Czarnikow allows for 600,000 tons of sugar to go unaccounted for, in what it describes as unrecorded disappearance in both years, leaving its latest estimate of the 1990-91 surplus at 2.2 million tons and the deficit next season at 740,000 tons.

Sugar at lowest price in 150 years ^③- SUGAR

DURBAN. — While demand for sugar is growing, the industry must compete with cheap, artificial sweeteners and not allow its product to be excluded from diet foods, the Canadian chairman of Tate & Lyle, Mr Neil Shaw said

this week.

ARC 21/9/71

Mr Shaw head of Europe's biggest sweetener manufacturer, spoke as guest of honour at the centenary banquet of CG Smith Sugar Company.

He said despite competition and the fact that sugar prices were at their lowest level in inflation-adjusted terms in 150 years, consumption of the sweetener had grown almost four-fold since 1950.

-COMPANIES-

Africa looks sweet for SA

25/9/91 PAUL ASH (3) 5/2/91

WHILE SA companies were major suppliers of sugar-processing plant in their "traditional" export markets such as Malawi and Zambia, fewer were competing in African markets newly opened to South Africans, Farm-AG International Trading director Robert Mason said yesterday.

SA business would face stiff competition from French, Brazilian and British companies which had established footholds in countries where SA had not been welcome until recently, he said.

Farm-AG International, a subsidiary of agricultural chemical and machinery manufacturer Farm-AG, is involved in two projects, worth about R4m, in West Africa.

One is the rebuilding of a sugar refinery; the other the upgrading of a milling tandem. Both are using SA-made equipment.

Durban-based Techserve is the largest exporter of sugar machinery from SA. MD Geoff Walsh said yesterday his firm had a technical assistance contract with Instituto Nacional Do Acucar in Mozambique. It was looking at contracts in Ivory Coast, Zaire and Kenya.

VAT concession for sugar cane growers

VAT relief in the form of a special 7% flat rate has been negotiated for small-scale sugar cane farmers by the SA Sugar Association (Sasa). *Blooms 26/9/91*

Most of the 35 000 small cane-growers would have suffered unfairly from the introduction of VAT, Sasa said yesterday.

However, flexibility in VAT legislation allowed the Commissioner of Inland Revenue to introduce a flat rate of dispensation calculated on the average cost of cane production, Sasa said.

 PAUL ASH ^{(3) Sugar}

The flat rate, which will apply to all growers who do not qualify for registration as vendors, will be set annually at a rate which will enable them to recover as input tax the VAT paid on purchases of farming equipment and supplies.

The rate will be set at R3,64/ton until the beginning of the 1992/93 season.

The move means growers will not have to keep complicated records yet ensures they will remain in the VAT system.

SA quota of sugar exports to US down 30% on pre-sanctions level

WILLIAM GILFILLAN

THE US quota for SA sugar imports has been cut by 30% to about 35 000 tons from about 45 500 tons in line with the reduction in the quota of imports of total foreign sugar into the US.

The US quota for SA sugar exports has been reinstated from tomorrow, as have 2.3% of overall annual US imports applicable before the Comprehensive Anti-Apartheid Act was passed in 1986.

On Friday the US authorities announced they had cut the quota for sugar imports for the year beginning tomorrow by 30% to 1.53m tons from 2.15m tons.

But South African Sugar Association (Sasa) export director David Hardy said at the weekend this had not been unexpected as US domestic sugar growers had experienced a good year with large crops being realised.

He said the US import quota for the year to end September 1991 had been

recognised as being higher than the imports required by the US and as a result stock levels in the US were fairly high.

Sasa chairman Glyn Taylor said that although SA's sugar exports to the US market were relatively small in volume terms, the US market was the only market in which SA sold sugar at a premium to the world price.

SA received about \$420 a ton for the sugar it exported to the US whereas the world price was about \$200 a ton.

In the season to end-March this year, SA exported just over 700 000 tons of sugar worth R555m.

Total production this year was slightly above 2-

million tons, and domestic sales just over 1.3-million tons.

US sugar growers said they feared the sugar quota could glut the market with foreign sugar and drive down their prices, while the Sweetener Users' Association said it supported the agricultural department's decision, reports Sapa-AP.

US sugar production is estimated at 7.37-million tons during the next 12 months, and consumption at 8.9-million tons.

The world sugar price closed at US9.59c/lb on Friday, down 2c.

Under the agriculture department quota system, a two-tiered level is used, allowing a fixed amount of sugar into the US at a relatively low duty rate of US0.625c/lb.

Sugar prospects look sweet

Star 20/10/91

JOHN SPIRA



UP AND DOWN
DIAGONAL ST

3 Sugar



SUGAR shares haven't made much running in recent months — a situation which is set to alter in the near term following the emergence of new factors that could produce a quantum boost in sugar company exports.

Investors should note that the international sugar market is facing a groundswell change as Cuba, the world's major exporter, gropes to adapt to the potential lapse of its traditional markets in Eastern Europe and the Soviet Union.

The long term impact is still not clear, but new opportunities for South African sugar exports are knocking at the door.

Cuba's long-standing market for its sugar exports to the Soviet Union is severely threatened.

In the past, 60 percent of its exportable sugar has been bought by Moscow — a market that could evaporate by the end of the year.

Talks on its renewal are now taking place but the chances of a new agreement are regarded as slim.

Cuba's sugar exports have already been disrupted by a sharp fall in sales to former communist countries in Eastern Europe and the country is desperately seeking to establish markets

for its sugar with the newly autonomous republics in the former Soviet Union.

Cuba's current sugar trade with the old Soviet Union involves swaps of sugar at relatively high prices for Soviet oil.

The Soviets have already cut back on oil supplies to Cuba and analysts believe that American pressure on the Soviet Union will ensure that the trade ceases entirely.

Other countries may also stop buying Cuban sugar, since a new Bill before the US Congress proposes that countries which import sugar from Cuba will not be allowed to sell sugar to the US.

Havana will find it difficult to reach any replacement swap deals with individual Soviet republics, which are seeking food aid in addition to sugar. Cuba is unable to oblige.

There is therefore a serious risk that a large volume of Cuban sugar will be available for export elsewhere by the end of this year.

Competing with other producers, including SA, for

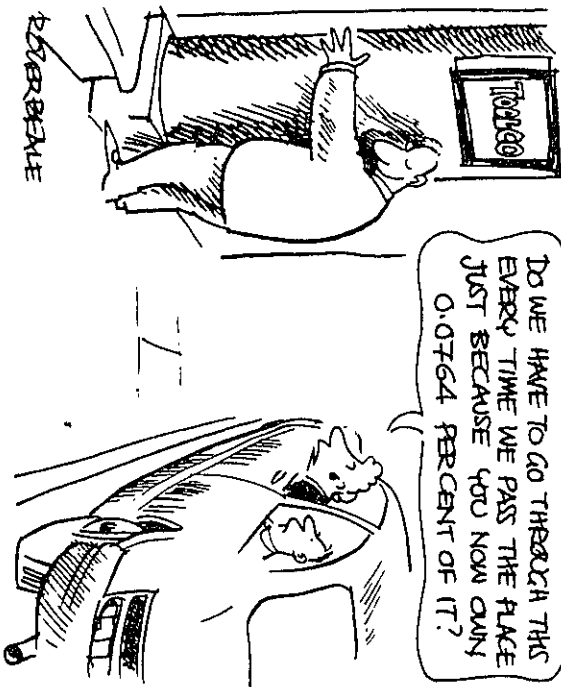

outlets in the free market promises to be far less attractive for Cuba than the present special deal with Moscow.

The market is oversup-

plied, with prices looking vulnerable following two seasons of surplus production and the prospect that 1991-92 will be the third in a row. Prices at around \$9 a

lb are still unprofitable for most producing countries.

The uncertainty surrounding the future of the guaranteed market for Cuban sugar in the Soviet Union has coincided with big falls in sales to other countries in Eastern Europe and the prospect of further falls following the collapse of Communist rule in Bulgaria last week.

Exports to the Soviet Union fell to 2.98 million tons in the first six months of this year compared with 3.31 million tons in the first half of last year. No shipments were made to Czechoslovakia and Romania compared with 64 935 tons and 196 849 tons respectively in the first half of 1990.

For the second year running, no sales were concluded with Hungary, while the unification of Germany has closed off the former East German market. The old East Germany bought 96 850 tons of sugar from Cuba in the first half of 1990.

Exports to Albania and Bulgaria were down materially in the first half of this year, while Cuba's imports of 615 000 tons were mar-

ginally down.

This has come at a time when the total Cuban harvest in 1990-91 fell by around 5 percent to 11.5 million tons as a result of bad weather and shortages of oil for transport.

Total Cuban exports in the first six months of 1991 were 4.93 million tons compared with 5.55 million tons in the first six months of 1990, according to the International Sugar Organisation.

What of the longer term impact of the loss of Cuban markets in the former communist states?

Some believe that Cuba will be forced to offer more of its sugar in the free markets and will be an aggressive seller, leading to lower prices.

In this event, SA would suffer consequences aggravated if the ending of the special Soviet/Cuban sugar relationship prompted the Soviets to expand their own sugar beet production.

Others argue that the longer term implications will be bullish for sugar prices on the basis that Soviet trade with Cuba in general will collapse, leading to intensified difficulties for the already severely weakened Cuban economy.

Former clients in rush for SA sugar

Bibany 18/10/91
DURBAN — SA's sugar industry is regaining lost ground abroad as anti-apartheid sanctions are dismantled, but for the moment it lacks the supplies to sweeten the palates of all interested buyers.

"People from countries that previously wouldn't have been seen dead in our boardrooms have been visiting," said SA Sugar Association (Sasa) executive director Michael Mathews.

But despite growing interest among potential new buyers and former clients, the industry will remain loyal to key Asian and other customers which continued to buy during sanctions.

"We are not chasing around for new markets," said Sasa's international marketing director David Hardy. "We are constrained by export availability now."

SA, the world's sixth biggest exporter, expected to ship 850 000 tons of raw sugar over the 1991/92 season up to next March 31, after 775 000 tons in 1990/91, he said.

Mathews said he expected the local sugar belt would produce 2,2-million to 2,3-million tons in the current season against 2,1-million in 1990/91.

Annual output could grow a further 250 000 tons over the next five years as a result of deregulation of the industry last year and plans to expand cane growing.

Mathews said buying interest had emerged from countries which had shunned SA during sanctions, including former customers like Canada.

He said the unravelling of sanctions had also paved the way for an unprecedented 10-year research agreement signed recently between SA, Australia, Brazil and the US on biotechnology, or genetic engineering of crops.

Another 10-year agreement was signed to supply neighbouring Botswana.

Sales start at 46 000 tons next year and are expected to rise by about 5% annually. — Reuter.

Deciduous, citrus fruit industries in merger

③ - SUGAR

et 5/11/91

Deputy Business Editor

THE SA citrus and deciduous fruit industries are to rationalise their European interests under a new service company, Fresh Fruit Services (FFS).

Leo Fine, chairman of Unifruco and Dave Lotter, chairman of the SA Co-operative Citrus Exchange said in a joint statement that the two organisations would relocate their European headquarters to a newly-acquired building in Farnham Royal, west of London.

In terms of the agreement, financial services, data processing, quality control and technical and logistical services will be jointly managed by a combined service company in Europe.

Marketing will continue to be conducted independently by the individual sales organisations of Cape and Outspan.

FFS will also provide supporting services to other marketing organisations associated with produce from SA and other sources.

A controlling company, Fresh Fruit International (FFI), embodying the partnership between Unifruco and SACCE, has been formed in SA and will co-ordinate "all opportunities for rationalisation and co-operation" between the two organisations.

The Board of FFI consists of five directors each of SACCE and Unifruco and the chairmanship will rotate between the two organisations with Lotter the first chairman and Fine the vice-chairman.

Unifruco and SACCE jointly export nearly 65-million cartons of fruit annually and this is expected to increase to 100-million cartons by 1995.

Small cane-grower to get help

Bloemfontein 19/11/91
SMALL cane-growers will need a R142m injection between 1991 and 1996 in the SA Sugar Association's (Sasa's) five-year plan to boost sugar production, an industry spokesman said yesterday.

Small growers are those who produce less than 150 tons of sucrose a year and who do not have access to conventional sources of finance.

Funds for the Sasa project, administered by the association's financial aid fund, will be raised through commercial banks and a recent R67m loan from the Independent Development Trust (IDT).

"We anticipate funding another 10 000 growers on 30 000 new hectares of high potential land," aid fund manager Richard Bates said yesterday.

Small cane growers within 30km of a mill were given free entry into the industry after partial deregulation of the industry in 1990, Sasa said in a special report on the aid fund.

The scrapping of Acts restricting

3 sugar
land ownership on the basis of race provided the opportunity for small farmers to expand production.

"Sugar cane, less prone to crop failure and with a semi-annual return, is well suited to the small grower," Bates said.

The project has also boosted employment and development in rural areas which before the project depended on breadwinners working in urban areas.

Farmers outside the 30km limit, however, were still subject to quotas and had to obtain small-grower titlement.

"Outside that limit, transport economics start affecting growers' profitability," Bates said.

The aid fund, which was started from a R5m fund set aside by Sasa in 1973, assists about 37 800 small growers in Natal, KwaZulu, KaNgwane, Transkei and the Eastern Transvaal.

PAUL ASH

Granite Sector Was 1991's Headache

MARTIN & Co's Richard Jesse said key investment events of 1991 were the ending of the Gulf war and thus no ultra-high oil price environment, selective easing of sanctions on SA; a fall in the firmand discount from around 25% to 8%; and dramatic improvement in the rating of industrial shares in SA with the average P:E ratio moving up from 9.3 at the end of January to the current 14.1 (tending to confirm forecast in this column a year ago that industrial shares would become "overvalued" in 1991).

"The best three performing sectors in 1991 have been printing and publishing (+144%) driven by a quadrupling in the M-Net price, transportation (+93%) and motors (+90%). The worst three have been other metals (-26%) with granite shares the villain; Evander gold (-21%) and tin (-19%)."

"What of 1992? International economies will be slow to get into gear, which will retard the performance of cyclical commodity-based shares. Golds should do better than in 1991...

"The ebb and flow of negotiations to establish the new SA will make for a bumpy ride in top quality industrials (and financials to a lesser extent), where the P:E ratings are already historically high. The best part of the market is likely to be selected second line industrials and financials... largely ignored by the institutions," Jesse said.

Mathison & Hollidge's Peter Redman said 1991's main feature had been the incredibly

Investors bumped their heads against a rock-hard, unforbearing granite sector this year. The uncertainty of SA will make sure that nothing is handed on a platter for 1992. **MERVYN HARRIS** reports in the third of a series of articles on brokers' prospects for the year ahead.

high and sustained level of industrial share prices despite high interest rates and relatively poor company results.

"Part of... this is due to the so-called 'house effect' of large institutional cash flows chasing too few blue chip stocks.

"In the third quarter the pressure was somewhat alleviated by the announcement of several large rights issues. I would expect more companies coming to the market with rights offers in 1992 and a cooling off in the industrial sectors.

"On the other hand, events in the US and the Soviet Union have begun to make precious metals, in particular gold and platinum, look more attractive and I foresee growing interest in the shares of mining companies."

Redman said the JSE's Traded Options Market would open in the new year, allowing investors to hedge risks in underlying securities. He hoped the confidence this should bring would improve activity levels in the equity market.

Cuba's sugar crisis a sweetener for SA

PAUL ASH

SA SUGAR producers are banking on a collapse in Cuban sugar production this year to stop an already weak sugar price from tumbling further.

A severe fuel shortage in the Caribbean state, caused by a slump in the supply of crude oil from the Soviet Union, has brought its sugar industry to a halt and it appears unlikely Cuba will be able to harvest much of its crop this season.

If the crop was harvested, however, the world market price, currently around 9 US cents a pound, could be substantially affected, SA Sugar Association (Sasa) economist David Hardy said yesterday.

Only 18 months ago, the world price was at 14-15 US cents a pound.

SA supplies about 820 000 tons a year to the world market. 511 000 6/12/91
If the Cubans manage to harvest a large portion of their crop, most would have to be sold on the open market and not under a preferential trade agreement with the Communist bloc, as was normally the case. This could push prices down even further.

The world market had "jumped quite a bit" on the back of the news from the Caribbean, Holcom Futures analyst Lindsay Williams said.

"The Cuban sugar industry is used to receiving high prices for their product and many growers might be forced out of business," he said.

"It also seems that Cuba has overextended itself on hedging and is being forced to buy back contracts on speculation of a bad crop," Williams said.



Slight drop for Lonrho Sugar

MARCIA KLEIN

SWAZILAND-registered Lonrho Sugar Corporation, which grows and mills sugar in Swaziland, Malawi, Mauritius and SA, has reported a small drop in earnings in the six months to end-September after showing continued growth since 1988.

The group's earnings fell by 7,3% to 217c (234c) a share in the period, mainly due to "unseasonal climatic conditions in Swaziland", directors said.

The interim dividend of 100c a share has been maintained.

Interim results reflect half the estimated profits for the current financial year, and the 1990 comparative figures are half the actual profits for the year.

Directors said actual figures had not been given as they would be misleading "in view of the seasonal na-

ture of the group's sugar operations".

The estimated figures show turnover grew by 8,8% to 208,1-million emalangeni (191,2-million emalangeni) and pre-tax profit declined by 5,4% to 51,4-million emalangeni (54,4-million).

Directors said this 5,4% drop, in line with predictions in the group's 1991 annual review, was mainly due to climatic conditions in Swaziland.

After taxation and minority interests, attributable profit was 7,3% down at 24,5-million emalangeni (26,4-million).

In the group's 1991 annual report directors expected a slight dip in profits in financial 1992 as the world market was in recession and there would be an expected surplus.

SWAZILAND
LONDON
SOUTH AFRICA

VITICULTURE & WINE

1990

Wine estates prepare for post-sanctions boom as exports rocket

8/19/90

CAPETOWN — Private wine estates have increased exports by up to 82% in recent months.

In a survey yesterday, all estates polled said exports had increased significantly.

KWV and Stellenbosh Farmers' Winery (SFW), who distribute the bulk of SA wines, are gearing up for an anticipated export boom after the lifting of sanctions.

Boschendal estate, one of the leading exporters of wine from the Paarl region, reported an 82% growth in exports to European countries over the year to September.

Estate manager Eddie Turner said that since the year-end he had received at least one export inquiry a day. Many were from Eastern bloc countries in search of bulk wine products.

Other private exporters, including Simonsig in Paarl, Neehlingshof near Stellenbosh, and Hamilton Russell Vineyards near Hermanus, also reported an upturn in foreign sales and enquiries.

The bulk of Boschendal's export growth was achieved during the last few months of the year — a trend which was possibly

LESLIE LAMBERT

more significant than the percentage growth which was achieved on relatively small volumes, Turner said. The same would probably apply to the other estates.

KWV, the organisation which represents SA wine producers, recently launched a major export promotion campaign to prepare the industry for the anticipated lifting of sanctions.

With the aim of getting branded SA wines back onto international shelves, the

organisation announced plans to strengthen its international marketing department and enter into agreements with producers and co-operative cellars to guarantee a supply of quality export wines.

Last year, KWV reported 85% growth in export volumes. This year, the organisation hopes to improve on this by adding the more profitable quality branded wines to its export lists.

KWV chairman Pieterman Hugo, said recently the industry was battling to keep pace with demand for bulk dry white wine

and fruit juice concentrate.

SFW, the leading distributor of SA wines and spirits, has also strengthened its export division to meet future demand.

Export manager John Sheppard said yesterday that some of the company's European agents were increasing their client bases, while buyers in Scandinavia and Canada, both of which have imposed sanctions on SA agricultural goods, were showing increased interest in SA wine because they believed the lifting of sanctions by their countries was imminent.

WINE sellers expect boom

Source: 12/14/90
Apartheid spoiled the bouquet of South Africa's wines for foreign buyers, but as the country moves towards a non-racial democracy its winemakers are gearing up for a boom in exports.

"If sanctions are lifted, we will go in with mega-money and mega-effort to establish South African brand names abroad," said Jannie le Roux Retief, chief marketing executive of the Co-operative Wine Growers Association (KWV).

KWV, based in Paarl in the heart of the Cape Province wine-growing region, controls nearly half of South Africa's bottled wine exports and 70 per cent of bulk sales abroad.

Drive 3

High on Retief's agenda is a drive to restore KWV brand names and South Africa's finest estate wines to the shelves in Western Europe and Canada once anti-apartheid sanctions are lifted.

He believes President F W de Klerk's pledge to replace white minority rule with a non-racial democracy could reopen the European market to South Africa within a year or two.

Wine exports dwindled during the 1980s when the world focus on apartheid made South African products unwelcome almost everywhere.

Dropped

KWV brandy lost its dominant one-quarter share of the market in Canada, and apartheid-tainted wines were dropped by supermarkets that controlled 52 per cent of British wine sales.

Sales to Eastern Europe, where markets have opened up since communist rule crumbled, have given exports new impetus.

KWV was formed in 1918 to stabilise wine production and sales through quotas and fixed minimum prices. *Own Correspondent.*

THE D



GLASS
TUMBLER
AMBER



Cape's wine taps set to flow

ST Times 16/12/90

JOHN PLATTER toasts the coming of a sanctions-free wine trade

SOUTH AFRICA shipped 20-million litres of wine in bulk to Poland last year, unlabelled — they label it there, omitting the Cape connection.

It's so potable the Poles have even been allowing the Pope to hand it out at communion in his native Krakow and, carbonated, it becomes a perfectly passable "champanski."

Their long tribulations make the Poles deserving recipients of generosity, but South Africa — not yet quite in a First World donor league — is practically giving away this wine. At well under R1 a bottle, it's also under the local legal minimum price.

Why, then, isn't this more affordable price used to initiate a larger body of local drinkers — South Africans still thirst for beer — to the charms of wine? Now there's a question. And the answer is hard currency. Poland pays in dollars.

In a sanctions-free world, if the present bulk exports were sold as fully branded Cape wines, South Africa could immediately quadruple its export earnings, besides, of course, expand volumes in present no-go markets.

Glut

But when Cape wine is permitted to flow rather than trickle back from its cold isolation into the wider world, how will it fare?

There's a saying in the hard school section of the English wine trade: "If they don't want a second glass, the wine's no bloody good." Will they want that second glass?

The world is in a wine glut (over-producing by two billion litres a year). Wine touters have to tout loudly. The puffery is deafening.

Choosy oenophiles have 36 wine producing countries to browse among and sniff from. In-

numerable heavyweight newcomers to the world of wine have found their international marketing feet in a rugged, crowded school in the years of South Africa's isolation and they cannot but roughen the ride for a Cape comeback.

The glories of Cape Constantia sipped — or more probably gugged, such was its appeal — at the courts of Europe in the 18th Century, are now obscure, undecipherable reminiscences from bygone times.

Even the grand, but heavily over-producing, self-subsiding French have seen their marketing emphasis on tradition and vintage artrana eroded before the brassy onslaught of new world wines.

Not only Ronald Reagan — who must have tweaked an ego when he served Napa Valley to Francois Mitterrand at the White House — but serious wine chaps everywhere have given up baulking at Australian or Californian chardonnay instead of Puligny-Montrachet.

No wonder the sanctioneers had little difficulty tainting the taste of Cape wine. Shut out from the major supermarket chains of Europe and generally ostracised and ignored along with most things South African, Cape wine has had to sneak in through back doors, distilled and discounted, disguised and hustled and re-labelled.

While of course the most vociferous moralists — Zambia and Zimbabwe among them — served Cape wine quite openly. Which is not to debate the morality of sanctions, only to wonder wearily once more at the curdling anomaly of self-righteous prigs.

So small wonder too that the odds and humiliation for the Cape wine exporters were sufficient to allow introspection and myopia to take its leaden hold. The industry even rationalised the predicament by gloating a little in the statistic of exporting "only five percent" of the crop — since this rendered it relatively immune from the anti-apartheid sanctions industry.

It has rendered it relatively free from prosperity, too. Bankruptcies among the Cape's 4900 wine farmers are running at their highest rate in memory, according to the KWV's chief executive, Fitzema de la Bat.

Plan

South Africa has a low annual per capita wine consumption of some nine litres, about one-eighth that of France and Italy.

Wine, unlike coal, say, which can be hurried in incognito via the tradesman's entrance, is always among a country's most visible exports, parading in full, labelled livery on dining tables.

However, De la Bat has a new plan and his name is Jamie Retief. Dr Retief, 39, is a KWV wonder boy with an outstanding record as KWV's European chief in the darkest days of the boycotts.

He still believes Europe is the key. He's understandably reticent about the details, but essentially his brief contained in a militantly precise programme codenamed Plan 90 which assumes sanctions begin to crumble in a big way by mid-1991, is to transform the legacy of anonymous, cut-rate tanker shipments into respectably labelled, new-image Cape wines.

He's been given about five years to ring the changes.

He's targeted some 20 countries from Japan to Singapore, even viticultural New Zealand, the Scandinavians, a number of African states, for obvious reasons, to the US and Canada.

Canada now takes nothing, but in pre-sanctions times every sixth bottle of wine drunk there was from the Cape. Retief is armed with a range of new wines, specially developed and named Cathedral Cellars, with an up-market, New World image to augment old faithfuls like Roodeberg.

Where does this leave the private, independent producers and wholesalers who've been a part of the sanctions-era trickle and who too would like to join the flow?

They may lack the volumes to make big-time market impact, but they have unquestionable superior quality, in many cases achieving genuine world-class standards.

Chardonnays from Hamilton Russell, Backsberg, Klein Constantia, Thelema, Buitenverwachting, clarets from Rustenberg, Klein Constantia, Warwick, Delheim, Kanonkop, Stellenryck, Welgemoed, Le Bonheur need bow to none. Retief insists they're essential to his comprehensive game plan, that these and other Cape flagships will be assisted in every way to follow in the wake, so to speak, of the KWV's slipstream.

Two factors rate in the Cape's favour: a chronically ailing rand and, for a time anyway, a honeymoon period of novelty. The 1990 vintage confirmed the Cape is well into a major quality renaissance, occasioned by more French-inspired technique and riskier intuition than the former rather one-dimensional, safer, predictable German methods. But all the world these days

makes fine chardonnay and claret. Why do we not, the our resur-gence to something more original, another red, one which, if made well, can be grand and fine, of which we have an abundance, which can be reasonably priced, and which no competitor has? Our own Pinotage.

I suspect they'd want a second glass of this quintessentially Cape flavour.

● The writer is a wine farmer and author of *John Platter's South African Wine Guide*.

③ wine + viticulture

Steps towards quality wine

THE 1990 Stellenbosch Farmers Winery (SFW) vintage report raises a number of issues central to the health of the wine industry as a whole.

There is a rule of thumb in Europe that when the trade is cautious about a vintage of average quality, it is because there is no shortage of stock in their cellars.

My first impression from the equivocal nature of the 1990 report is that the country's wholesalers are overstocked and there is no need to "talk up" the quality of the harvest.

The observation tallies with the state of the trade. The stagnant wine market and high interest rates are forcing negotiants to keep stock levels as low as possible.

Yet this is too simplistic and too cynical an approach to some of the more disturbing observations in the SFW report. Even assuming that in boom times one might have been more enthusiastic, the substance of the document warrants careful

consideration.

What worries the man who is responsible for most of SFW's bulk buying is that, despite vast investments in vineyards, harvesting methods and cellar technology, quality in a slightly patchy vintage has been disappointing.

Grapes and grape production are state of the art: the wines turn out to be neutral.

Wine buyer Jeff Wedgewood provides his own explanation: "In the past, SA was criticised for having the worst vineyards in the world. This was a visual observation. The vines looked bad due to a virus problem.

"We then put our effort into growing vines that looked good; we are now producing vines that have a vigour problem."

Maiden vintages from these young vines are usually excellent; as the vines get older, however, the wines get more neutral. This is contrary to what is customary in the world's

great wine producing regions. Young vines usually produce thin, stinky wines. Vines must be 15 to 20 years old before they can be relied upon to yield great wines.

The Cape's soils and climate are generally too generous for quality wine production. The vines should be made to struggle more, and especially now, where the best clonal material has been planted in perfectly prepared vineyards, they flourish too prolifically.

The problem is not insurmountable: vigour can be controlled if the farmer aims for quality, not quantity. The industry must lay down detailed guidelines, with premiums paid for grapes satisfying specific criteria.

Finally, the merchants (as well as the KWV as the buyer of last resort) must abandon purchases at the minimum price. Such insurance is no incentive to quality grape production.

MICHAEL FRIDJHON

Caveat emptor

The big wine wholesalers thought they were getting rid of a pesky irritant when a regulation that discontinued the use of gold neckbands on wine bottles to signify superior quality went into effect on July 1.

But now the small wine producers, who relied heavily on the gold seal of approval, are apparently plotting a counter-attack. They say they are "planning something that will help us fight back." For now, however, they won't comment on reports that they're considering establishing an independent wine testing and grading authority.

Small producers believe the big wholesalers persuaded the Department of Agriculture to make the change in order to boost sales of their own wines, whatever the quality. Small producers say the old system helped them compete because it saved them money in marketing their better wines.

"Superior labels were a relatively inexpensive way for us to market our better wines," says Frans Malan of Simonsig. "We are losing a valuable marketing tool. How are we going to tell the consumer which of our wines are as good as and maybe better than theirs? (The big wholesalers) can afford to spend R500 000 promoting any wine they want."

Riaan Kruger, director of the Cape Wine and Spirit Institute and spokesman for Distillers Corp, one of the largest wholesalers, says the industry's major players believed that the law should be changed. "They wanted to move away from a system where the seal on a bottle indicates the quality of the wine in it."

He says the old system wasn't fair because it ignored blended wines and allowed only wines whose vintage, cultivar and origin could be certified to qualify for the superior grade. "That gave buyers the impression that only a portion of the industry can make superior wine."

Malan, who was a member of the six-member committee that awarded the gold neckbands, admits that the system was imperfect and needed fine-tuning, but says it should not have been scrapped. "Dumping the system the way they did was like throwing the baby away with the bathwater."

Günter Brözel of the Neethlingshof estate says: "The big makers rely on their trademarks and were upset by the number of small wine makers whose wines were being judged superior. The superior seal was prized. It promoted healthy competition and it led to improving all wines in SA."

Vaughan Johnson, a Johannesburg liquor merchant believes it's important to indicate the quality of a wine to compensate for the average customer's lack of knowledge. This is done in Bordeaux and Burgundy, where vineyards are graded according to quality.

It seems that SA's wine industry could learn a thing or two from its European counterpart — that's if it hasn't learnt enough already.

David Pincus

April 23/8/90

(36/1) (15) (10)

SA booze beats boycott

The Argus Foreign Service
LONDON. — South African wine and beer are losing some of their stigma and selling 30 percent more across Britain this year.

"I know what has made the difference," said Mrs Margaret Steadman of importers Edward Cavendish. "The release of Mandela."

The freeing of the African National Congress leader and President De Klerk's reforms have apparently loosened inhibitions to such an extent that Britons are now recognising the "good quality and value for money" of South African wines.

White wines have proved most popular, particularly the Chenin Blanc and Sauvignon Blanc lines imported by Edward Cavendish.

Castle and Lion lager have been selling well, helped per-

haps by a heatwave.

The new attitude has resulted in South African wines reappearing on restaurant wine lists.

Mr Norman Kramer, of importers Collisons, said there had "definitely been a softening" towards buying South African wines.

He said the increased demand had arisen from word of mouth. He predicted it would soar when supermarkets start displaying Cape wines prominently.

But he warned that the increased sales could be hampered by recent price increases on the products from South Africa.

The issue of selling South African products is still sensitive enough for all the outlets interviewed here to decline to give figures on how much they sell.

La Motte's reds herald change for Franschhoek

⁽³⁾ Wine + Viticulture

THE launch of the La Motte estate's red wines heralds important changes for the whole Franschhoek region.

Until 10 years ago Franschhoek was regarded as something of a "valley too far". Merchants preferred the accessibility of Paarl or Stellenbosch, and the cooler climate also militated against cheap wine production.

The discovery of Franschhoek's quality wine potential and the marketing hype which has put the region on the map have changed life there.

La Motte's renaissance ante-dates the main rush to buy into Franschhoek. The estate was purchased by the Rupert family in 1970. Since 1985 it has been controlled by Anton Rupert's son-in-law Paul Neethling and his wife Hanneli.

Winemaker Jacques Borman works very closely with Neethling; there is a synergy in their relationship and in their understanding of the wine-making craft.

Late last year Neethling launched his 1989 Sauvignon Blanc — an unwooded, fragrant, slightly smoky wine which seems to have found for itself a unique position on the Sauvignon spectrum. Later this year the wooded version — to be sold as a Blanc Fume — will come to the market. I have tasted the pre-release samples and believe that it, too, will occupy an important place in the Cape's white wine hierarchy.

The launch this winter of the first vintages of Cabernet and Shiraz — both 1985, both certified Superior — confirms that La Motte (and Franschhoek) are not condemned to flourish only with white wines.

In the pipeline is something of a crescendo of reds: the 1986 Shiraz and Cabernet, both featured at last January's New World Wine Auction. The regular bottlings of these wines are showing considerable intensity of fruit and flavour. The younger Cabernets and Merlots are both benchmark wines.

The 1985 reds should retail for less than R30; the white wines — when available — sell for R10,15.

Bargain hunters may be disappointed but serious collectors will find, in time, pleasure in proportion to their investment.

MICHAEL FRIDJHON

Cold blast ahead

The winds of change gusting around SA at the moment will certainly whip up some dust in the sleepier corners of the Cape winelands. Now that the spotlight is not focused solely on the country's negative achievements, the Real World will have a chance to intervene.

On February 2, when President F W de Klerk announced his proposals for a new SA, I was phoned from London by the news editor of one of the most influential publications in the UK wine trade. He wanted me to put together an article on the changed prospects for SA's wine exports. He recognised that this country's new direction would make its wines politically acceptable in several markets where sanctions or social pressure had taken their toll.

Markets and prices

For Cape wine producers, these prospects have not arrived a moment too soon. Supply of premium wines is moving well ahead of demand. Export markets may take up some of the surplus; they could certainly help to support domestic prices. However, renewed political acceptability is not all that Cape wines will require.

Small quantities will no doubt sell to those who have a special affinity for the Cape, or to those merely curious, but if substantial volumes are to find a regular demand at a reasonable export price, they will have to compete against all-comers in the EC.

Most of SA's wine sales to the UK are not particularly profitable. When producers do sell at normal prices their volumes are minuscule. Achieving a balance between these two extremes will require a concerted marketing campaign and realistic sense (on the part of SA producers) about the market value.

Even with the rand at its lowest point against the French franc, SA importers are landing top-quality Chardonnay from Burgundy to sell for R20,25 a bottle. Bearing in mind the cost of importing the wine, and duties of surcharge, you can easily assume that the net export price for the wine in France is somewhat less than half that. At present there aren't too many local Chardonnays which wholesale for less than R12 a bottle.

Those Cape producers who would like to take advantage of the welcome being extended abroad to SA will have to price realistically.

This is the cost of life outside the vacuum. It does have the advantage of providing penetrating realism. The Cape estates will come to appreciate the kind of quality which competitors abroad can offer at very attractive prices. They may then be prepared to abandon

their protective shell to occupy a more permanent place in the real world.

For consumers in SA, this could mean international quality for less than we are paying today.

Michael Fridjhon

FIM 25/5/90 (3) wine + viticulture

WINE FIM 25/5/90

Counting the cost

The Bergkelder's recent launch of two super-premium wines — Aan de Wagenweg Chardonnay 1988 and Blanc Fume 1989 — poses a number of interesting questions about the obligations of producer and consumer in the world of de luxe wine.

Aan de Wagenweg is a brand name, not an estate. In creating its flagship The Bergkelder chose to honour the name of the cul-de-sac in which its offices are situated: the short road, off Dorp Street, is part of the original wagon road linking Stellenbosch to Cape Town. (3) wine + viticulture

The decision to source its super-premium wines from several vineyards rather than from a single estate is an interesting one. The Bergkelder crushes thousands of tons of Chardonnay and Sauvignon Blanc annually. By retaining flexibility in terms of the origin of the grapes going into the wine, it can select the best 30 tons or so of each of the two varieties for the Aan de Wagenweg wine.

As to the wines themselves: the Blanc Fume is one of the finest examples of a wood-matured Sauvignon Blanc in SA — and, for that matter, in the New World. There is a complexity, elegance and delicacy not usually associated with this varietal. It is not a big wine. However, its balance and extraordinary aftertaste justifies the R20 per bottle price tag.

The Chardonnay has been beautifully handled in the cellar so that the wood char-

acter gives the varietal a perfect platform. I suspect that it will always lack a little fleshiness and that the gap between wine and wood will never close completely. While it is one of the best 1988 Chardonnays it has already been overtaken by several of the 1989s and, probably, a great number of the 1990s.

All this leads to the essential questions about producer-consumer responsibility in a market where the Chardonnay has been pitched at R40 per bottle and the Blanc Fume at R20. Both wines are available in very limited quantities (approximately 2 000 dozen each). Implicit in such a launch is the marketing department's recognition of consumer frailty: if the wine has the right pedigree and a suitably outrageous price, and if the quantities are always properly limited, you can rely on buyers at the top end of the market to take up all the stock.

Free trade philosophy commends this opportunism, at least in the short term. But perhaps it contains the seeds of its own destruction. Pitching branded wines above estate wines must undermine the estate wine concept; selling a Chardonnay at double the price of an infinitely better Blanc Fume (comparing apples with pears on the grounds that they are both fruit) suggests that cultivar will always be more important than quality. The logical conclusion is that you can forever foist inferior wines from more desirable varieties on to a gullible public.

The sad fact is that this sort of cynicism is vindicated by the marketplace. The wine will sell out and the treadmill will turn. For the foreseeable future there will always be enough buyers to replace the disillusioned.

One day the whole edifice will collapse. When the cost is counted then, however, I wonder if the losses will be justified by the short-term gains.

Michael Fridjhon

Call on KWV to fix wine price

Political Staff

Call Times 31/5/90 comes.

(3 wine)

KWV should make a total reassessment of its approach to fixing the prices of good wine, the Democratic Party MP for Simon's Town, Mr Jannie Momberg, said yesterday.

"In spite of increasing production and surpluses, the KWV is still busy increasing wine prices every year," he said during the debate on the Wine and Spirit Control Amendment Bill.

"The consequence is still diminishing consumption and declining in-

"I believe the KWV must seriously considering bringing down the price of wines so that demand can increase.

"I wonder if the time has not come for KWV to seriously consider lowering the minimum price for the large amount of good wine and to fix a quality price for rare sorts.

"This will provide a protection and an incentive to those producers who want to plant rare and quality varieties."

1990

1.
117
6
10
1

FINANCE

Shake-up of wine industry

Structure of wine
Monday 20/3/90

MICHAEL FRIDJHON

THE predicted shake-out of the fine wine industry began in earnest at the end of March at the 16th annual Nederburg Auction. Prices on a number of wines were palpably brittle, several items were indigestibly large in relation to buyers' interest and some lots were unsold.

While the overall results still show a price increase compared with previous years, bids were clearly more selective. Retailers

sought out wines whose sales potential seemed relatively assured.

Hardly surprisingly, the Nederburg Auction wines performed in a manner which must have gratified the organisers. In the past year, Nederburg has spent a considerable amount in branding those wines which are only released at the Nederburg auction.

Together with the Bergkelder Tender advertising campaign, this represents

the largest above-the-line investment in the premium wine market.

The 1990 auction left no doubt as to the value of this campaign for the advertiser. Trade buyers at Nederburg seem to have concentrated their attention on these auction releases, buying thousands of cases of Nederburg wines at prices which were much higher than in the past.

By the same token, small parcels of estate and private producer wines which have always added variety to the catalogue battled to

attract sufficient bids. Many sold at a rand or two above reserve.

Several parcels had to be broken up by the auctioneer to be offered in more manageable quantities. More than one quite well known producer suffered the indignity of not attracting a single bid.

If there was a pattern to this buying, it seemed as if the trade had at last learnt to distinguish between wines of special quality and auction rarity, and wines which but for their being a year or two older than current vintages were merely standard release stocks.

The 1990 auction has proved to be a watershed. A flood of quality wines and high interest rates has forced trade buyers to exercise discrimination.

Most importantly, the premium wine industry cannot afford to ignore the signs: the great weeding out process has begun, and only the best prepared among the finest wine producers will emerge unscathed.

Wine producers hope to toast a vintage year

CAPE TOWN — Wine producers whose annual income grew by only 6,8% last year may see growth of more than 15% this year, if early indications of improved domestic and export sales are anything to go by.

Exports of grape juice have also soared and production is now on a 24-hour basis at the KWV plant at Robertson.

KWV chairman Pietman Hugo told members at yesterday's annual meeting in Paarl that provisional estimates indicated their income in 1990 would exceed the rate of inflation. KWV represents about 6 000 wine producers in the western Cape.

LESLEY LAMBERT

KWV CE Ritzema de la Bat said in an interview that a number of factors had contributed to the newfound optimism. On the international side, export sales, which grew by an impressive 85% last year, were expected to show further growth this year.

Hugo and De la Bat confirmed that former business associates in countries which imposed boycotts against SA had started re-establishing contact and were preparing themselves for renewed trade.

De la Bat said the Canadians, the biggest international buyers of SA wines before

sanctions, had shown the greatest interest, although there had also been some encouraging signs from other former buyers, including the US. 5104 114/90

This year the domestic wine industry was also expected to contribute to overall growth after stagnating over the past few years, De la Bat said.

This year's growth is forecast off a low base. KWV reported 27% profit growth to R34,97m. The bonus paid to farmers was increased from 66% of the net income to 75%, but the average 6,8% growth in net income to R452m remained disappointing.

'Improved perceptions' to boost liquor exports

CAPE TOWN — Stellenbosch Farmers Winery (SFW), which markets the produce of Western Cape wine producers and co-operatives, has created a position for a director of international marketing in anticipation of improved relations with its export markets. *(3) Viticulture & Wine*

The company has had indications that improved political perceptions will make SA wines more acceptable overseas, according to a spokesman.

The liquor industry benefited from significant growth in exports last year. This was confirmed in the annual report of KWV which reported exceptional growth of 85% in export sales of brandy, grape juice concentrate and natural wines in

8/10 am 5/4/90
LESLEY LAMBERT

1989.

With expectations of further improvements, SFW created the position of international director for Dick Coleshaw, formerly a senior manager in the organisation, as part of a major reorganisation in its commercial division.

KWV, the producer organisation which represents 6 000 grape growers, announced in its annual report that, while the export volume of branded products had been slightly reduced last year, grape juice concentrate and brandy had almost doubled. New international markets were found for

To Page 2

Liquor exports

8/10 am 5/4/90
bulk natural wines.

Although the industry does not disclose the nominal value of its export earnings, they are understood to have contributed substantially to total income. *(3) Viticulture & Wine*

KWV deputy marketing CE Kobus van Niekerk agreed that improved perceptions of SA were expected to boost liquor exports but cautioned that other circumstances, like economic pressures on UK consumers, could inhibit some of the anticipated growth.

While the industry welcomes export growth, it would also like to see similar

improvements in its stagnant domestic market. Much energy is expected to be invested in promoting local sales this year.

KWV reported a record wine crop of 9,56 hectolitres last year, 5% greater than the previous year's crop. While it received 18% more distilling wine during the period under review, domestic sales of neutral wine distillate and brandy from the distilling wine pool decreased by 4.4%, largely as a result of further rationalisation of wholesalers' stocks, the report said.

This meant that 45% more wine and distilling wine was available for export.

From Page 1

Wine exports up by 85% — but locals go slow

3 Wine
ALG
3/4/90

By ANDREA WEISS
Staff Reporter

KWV increased their export turnover by an exceptional 85 percent during 1989 to dispose of a wine crop which was the largest yet in the industry.

However, sales on the domestic market were sluggish, according to the KWV chairman Mr Pietman Hugo's annual report.

The 1989 wine crop was five percent larger than the last record of 9,1 million hectolitres in 1983. The crop follows relatively big crops in 1987 and 1988 and has been ascribed to favourable conditions during the growing season.

During the "exceptional export year" of 1989, grape concentrate and brandy exports doubled while brand products showed a slight drop in volume.

New markets were found for

bulk natural (unblended) wines making this a "significant category" on the international market.

The good export results were achieved in a market environment "which did not always favour South Africa", Mr Hugo points out.

Local consumer spending at retail level was only one percent higher than in 1988.

Sales of medium-priced wines dropped by about seven percent and those of natural wines by 0,3 percent.

The demand for high-priced red wine grew by 4,4 percent and sparkling wine showed a 14 percent growth. The brandy market showed a five percent increase.

The producers' income from the 1989 wine crop was R451,75 million which is an increase of 6,6 percent on 1988.

The KWV's net income for 1989 was R35 million compared

to an income of R27 million in 1988.

● The Rural Foundation has agreed to develop a manpower code and a set of guidelines for personnel practices in the wine industry following negotiations with the KWV, Mr Hugo announced.

But the code to be developed this year will not be "prescribed" to producers.

Last year, 23 co-operatives concluded recognition agreements with the National Union of Wine, Spirits and Allied Workers. A total of 14 cellars also negotiated with this union regarding employee benefits, according to Mr Hugo.

Tribute to police dead

PRETORIA. — Policemen here have paid tribute in a memorial service to the 71 members of the force who died on duty in the past 12 months. — The Argus Correspondent.

Hops industry to earn R8m

GERALD REILLY

PRETORIA — The hops industry will earn producers nearly R8m on a crop of 680 tons of processed hops this year, Agriculture and Water Supply Minister Kraal van Niekerk said in George last week. *biday 5/3/90*

Speaking at a hops festival, he said this should provide the country with 45% of its needs.

SA breweries produced 170 tons of the dairy product on its own land last year, while producers under contract delivered another 417 tons.

This amounted to 33% of the brewing industry's total requirements, and earned R5,7m.

The balance had to be imported but production was increasing, Van Niekerk said. *2/2/90*

Within the next five years, local production was expected to supply up to 70% of the local need.

③ *Uitkultuur
funde*

Wine farms sold as costs outstrip income

AR 643
24/1/90

3 Wine

By HENRI du PLESSIS
Staff Reporter

INCREASES in the producer price of wine have not kept pace with input costs, forcing several Western Cape wine farmers to sell their farms.

Others have turned to mixed farming to enhance their gross income.

Yet others have stuck it out, only to find they cannot fund development or extension of their operations.

The farms which have been sold are mostly smaller units in the Breede River Valley.

Mr Dave Richter, of Goudini, said basic costs such as the price of tractors or chemicals had increased by more than the official inflation rate, while the farmers would see "only a true

average increase of about 6 percent in our income".

"The price of distilling wine is only R204,04 a ton, which means the real increase since last year is only 3,4 percent.

"We do not have a problem making good wine, but if the trade cannot sell it, we have to sell it as distilling wine.

Last year, he said, the trade had been overstocked. "But I feel more positive about the year ahead. I have been told the stocks have been sold and our market should be back to normal again this year."

However, he confirmed that farms in the Breede River Valley had been sold. "It is mostly smaller farms that are sold. If you want to make a living in wine these days, you have to have large units — the smaller ones do not pay anymore."

Mr Alwyn Mostert, manager of Aan-de-Doorns wine cellar, also said the small increase in the price of distilling wine was where the problem lay. "Farmers are definitely finding they cannot extend their operations," he said.

"I would say about 60 percent of the crops here go towards the making of distilling wine and the price has been increased only about 12 percent (this year).

"Of this, nine percent goes to 'export costs' (the surplus pool), so the farmer sees only about three percent."

Mr Mostert said many farmers in the vicinity of the cellar had switched to mixed farming, especially potatoes, milk and onions.

Mr John J Rabie, of the farm Leipzig near Nuy, a mixed

farm, said: "I can't think how farmers make a living these days. Basic costs are too high to cope with, while the middlemen in agriculture take such large bites out of everything."

The size of the wine-grape harvest has increased steadily and although this generates more money, unit prices have fallen — which means individual farmers have to extend their operations to keep pace.

However, basic input costs are already increasing at more than the inflation rate, eroding the profits to be gained from extension.

● The harvest in 1980 was worth R148,5-m. This grew to R217,3-m in 1983, and R423,6-m in 1988.

A record 956 million litres was made last year.

KWV AND THE WINE PRICE RITUAL

③ Viticulture & wine

A familiar, yet strange, ritual was played out again this week in Paarl. The KWV wisemen got together to declare new minimum wine prices to be paid to producers. FIM 19/11/90

Since 1985 sales of drinking wine have been dropping steadily (from 279,7 Ml to 273,4 Ml in 1988. Industry consensus is that the market is unlikely to have shown any growth in 1989).

Over the same period the total wine crop has grown by around 15%. Normally, that combination of factors would cause prices to fall. Yet the effect of KWV's announcement is that the price of quality wines will increase by 15% while standard and distilling wine prices will go up by 12%.

For this state of affairs we are supposed to be thankful. KWV chairman Pietman Hugo states that it was only by dint of a "considerable sacrifice" on the part of wine farmers that it had once again been possible to keep minimum price increases under the inflation rate. This, of course, has everything to do with self-interest and nothing to do with altruism. Wine farmers are getting poorer because they can't get their market to grow, not be-

cause of any noble policy of self-denial.

The KWV notes that 74% of the crop will be disposed of locally (43% as wine and 31% as spirits).

The balance (historically referred to as the surplus) will be sold abroad. The KWV says markets for this portion of the crop have already been found so the total crop will be sold. This is some, but not much, consolation.

That portion of the crop (57%) not sold locally as wine is sold at a considerable discount. Some will be disposed of for as much as R40/hl but much of it will sell for under R28/hl — compared with the minimum good wine price in 1990 of R88,48/hl (*Business* December 1 1989). The industry would be in a much healthier position if local wine sales rose so that the portion of surplus to local requirements fell.

Despite increasing rumblings in the industry that the minimum price mechanism should be altered (*Business* November 10 1989), the KWV saw fit not to alter the status quo.

An announcement at the KWV annual meeting in April is possible. We remain optimistic.

KWV increases wine price for farmers

THE KWV has announced an increase of at least 12% in the minimum price paid to farmers for wines. *Q10am 15/11/90*

There will be a 15% rise in the minimum price paid to farmers for wine purchased for quality table wines, 12% for wine used for standard priced bulk wines and also 12% for wine purchased for distilling purposes. *(12%)*

A KWV spokesman said in a statement that 26% of the 1990 crop would be exported as various products for which

markets had already been found, while 43% would be sold as wine on the domestic market and the remaining 31% as spirits on the domestic market.

The total crop is estimated at 952-million litres. *(2) Viticulture + wine*

KWV chairman Pietman Hugo said the farmers were still striving to stimulate the market through a conservative but market-related price policy.

He said even after the increase the farmer would still only receive 56c a bottle for standard priced wines. — Sapa.